

# T A B L E O F C O N T E N T S

## USER INSTRUCTIONS SECTION

<b>PART</b>	<b>DESCRIPTION</b>	<b>PAGE</b>
<b><u>1</u></b>	<b><u>ENHANCED DISPLAY PROGRAMMING</u></b>	
	1.1 OVERVIEW .....	1.1
	1.2 LOCKING YOUR KEYSSET .....	1.4
	1.3 CHANGING YOUR PASSCODE .....	1.5
	1.4 CALL FORWARDING.....	1.6
	1.5 SETTING YOUR ANSWER MODE.....	1.8
	1.6 PROGRAMMING YOUR STATION'S NAME.....	1.9
	1.7 PROGRAMMING PERSONAL SPEED DIAL LOCATIONS .....	1.11
	1.8 NAMING YOUR PERSONAL SPEED DIAL LOCATIONS .....	1.12
	1.9 ADDING EXTENDERS TO KEYS .....	1.13
	1.10 CHECKING STATION STATUS.....	1.14
	1.11 CHANGING YOUR TIME AND DATE DISPLAY .....	1.15
	1.12 SETTING STATION ON/OFF OPTIONS .....	1.16
	1.13 SELECTING A RING TONE .....	1.19
	1.14 ALARM REMINDER.....	1.20
	1.15 STATION VOLUME .....	1.21
	1.16 SETTING A PROGRAMMED MESSAGE.....	1.23
	1.17 ALARM REMINDER WITH MESSAGE .....	1.24
	1.18 CALLER ID DISPLAY.....	1.25
<b><u>2</u></b>	<b><u>SMT-i5243 USER GUIDE</u></b>	
<b><u>3</u></b>	<b><u>SMT-i5230 USER GUIDE</u></b>	
<b><u>4</u></b>	<b><u>SMT-i5220 USER GUIDE</u></b>	
<b><u>5</u></b>	<b><u>SMT-i5210 USER GUIDE</u></b>	
<b><u>6</u></b>	<b><u>SMT-i3105 USER GUIDE</u></b>	
<b><u>7</u></b>	<b><u>MOBEX USER GUIDE</u></b>	
<b><u>8</u></b>	<b><u>ITP-5112L USER GUIDE</u></b>	
<b><u>9</u></b>	<b><u>ITP-5121D USER GUIDE</u></b>	

- 10**      **ITP-5107S USER GUIDE**
- 11**      **DS 5000 SERIES USER GUIDE**
- 12**      **iDCS KEYSET USER GUIDE**
- 13**      **DCS KEYSET USER GUIDE**
- 14**      **SYSTEM ADMINISTRATION AND SPECIAL FEATURES GUIDE**
- 15**      **STANDARD TELEPHONE USER GUIDE**

# PART 1. ENHANCED DISPLAY PROGRAMMING

## 1.1 OVERVIEW

### • iDCS KEYSETS

This diagram illustrates the keys on a **iDCS 28 BUTTON** and a **iDCS 18 BUTTON** keyset that have special functions during programming. When required, these keys will be referred to by the names described in the diagram.

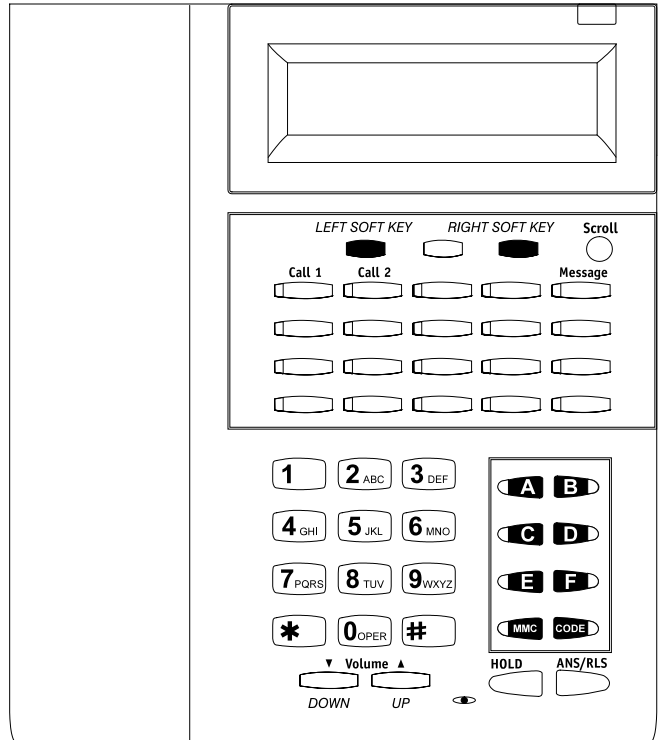

This diagram illustrates the keys on a **iDCS 8 BUTTON keyset** that have special functions during programming. When required, these keys will be referred to by the names described in the diagram.

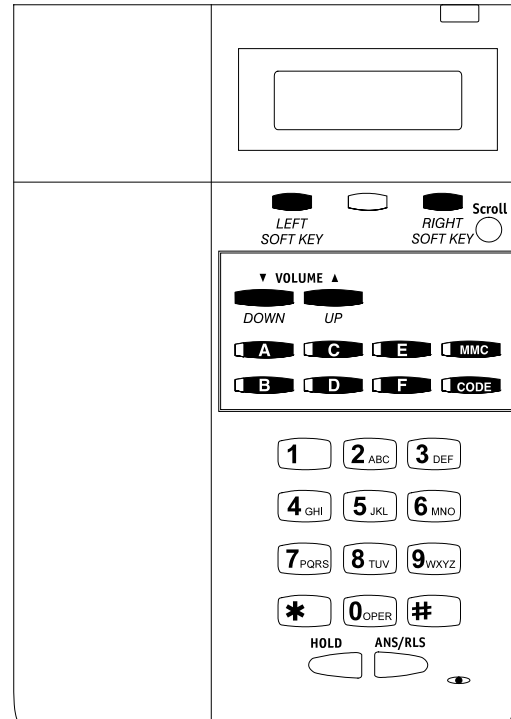

- **ITP and DS 5000 Series Keysets**

This diagram illustrates the keys on an **ITP 5121-D keyset**. The ITP and DS 5000 keysets have keys that have special functions during programming. When required, these keys will be referred to by the names described in the diagram.

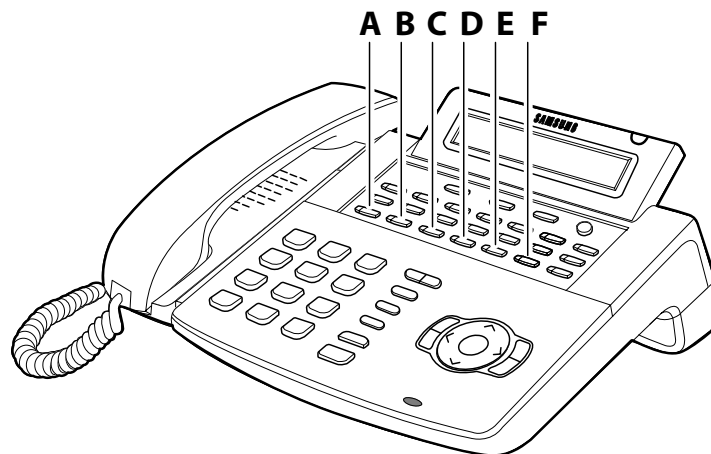

• **SMT-i Series Keysets**

SMT-i3105



SMT-i5210



SMT-i5220



SMT-i5230



SMT-i5243



## 1.2 LOCKING YOUR KEYSSET

You can lock your keyset to prevent other people from making or receiving calls while you are away. You can unlock it when you return.

### ACTION

1. Press the **transfer key** followed by **100**  
Display shows
2. Enter your passcode  
Default is 1234
3. Enter **1** for locking outgoing calls (Internal calls will still be allowed).
4. Enter **2** for locking all calls (Internal and external calls will not be allowed).
5. Enter **0** to unlock your phone.
6. Press the **transfer key** to save and exit

### DISPLAY

[ 201 ] STN LOCK  
PASSCODE: \_

[ 201 ] STN LOCK  
UNLOCKED

[ 201 ] STN LOCK  
LOCKED OUTGOING  
OR

[ 201 ] STN LOCK  
LOCKED ALL CALLS

[ 201 ] STN LOCK  
UNLOCKED

## 1.3 CHANGING YOUR PASSCODE

Each keyset user can set or change his/her individual passcode. This passcode is used to lock or unlock keysets, for toll restriction override and to access the DISA feature.

NOTE: Default passcodes cannot be used for toll restriction override or for DISA access.

### ACTION

### DISPLAY

1. Press the **transfer key** followed by **101**  
Display shows
2. Enter the existing passcode (default = 1234)
3. Enter the new passcode
4. Reenter the new passcode to verify the number  
If reentered correctly, display shows
5. Press the **transfer key** to save and exit

[ 201 ] PASSCODE  
OLD CODE : \_

[ 201 ] PASSCODE  
OLD CODE : \*\*\*\*

[ 201 ] PASSCODE  
NEW CODE : \_

[ 201 ] PASSCODE  
VERIFY : SUCCESS

## 1.4 CALL FORWARDING

The OfficeServ 7030 allows the system administrator to program the call forward destinations for other station users. This MMC also allows call forward to be set after the destination has been entered.

The OfficeServ 7030 system allows six types of call forwarding. There is an option, FORWARD BUSY/NO ANSWER, that allows both busy and no answer to be activated at the same time, provided that destinations have been entered for both. The destinations for all these forwards can be either an internal number or an external number.

0 = FORWARD CANCEL

1 = ALL CALL

2 = BUSY

3 = NO ANSWER

4 = BUSY/NO ANSWER

5 = FORWARD DND

6 = FOLLOW ME

0 = FORWARD CANCEL

This option will cancel any call forwarding set [in MMC 102](#). It will not remove the programmed destination and will not override any preset forward settings [in MMC 316](#).

1 = ALL CALL

This option, when set, will forward all calls to the programmed destination. If the programmed destination is a station then that station can call the forwarded station to put calls through.

2 = BUSY

This option, when set, will forward calls to the programmed destination when the forwarded keyset is busy.

3 = NO ANSWER

This option, when set, will forward calls to the programmed destination if the forwarded station does not answer a call before the forward no answer timer [in MMC 502](#) expires.

4 = BUSY/NO ANSWER

This option will activate both the BUSY option and the NO ANSWER option at the same time.

5 = FWD DND

This option will forward all calls to the programmed destination whenever the forwarded station goes into DND.

6 = FOLLOW ME

This option will forward all calls from another station to this one.



**ACTION**

**DISPLAY**

1. Press the transfer key followed by 102  
Display shows
2. Dial 0 – \* to select forward type  
OR  
Press UP or DOWN to select forward type and  
press RIGHT soft key to move cursor
3. Dial destination number (e.g., 201)  
OR  
Press UP or DOWN to select destination and  
press RIGHT soft key to move cursor
4. Dial 1 for YES, 0 for NO  
OR  
Press UP or DOWN to select YES or NO and  
press RIGHT soft key to return to step 2
5. Press the transfer key to store and exit

[ 201 ] FORWARD  
0:FORWARD CANCEL

[ 201 ] FORWARD  
1:ALL CALL:NONE

[ 201 ] FORWARD  
1:ALL CALL:205

[ 201 ] FORWARD  
CURRENTLY SET :YES

## 1.5 SETTING YOUR ANSWER MODE

Each keyset can have its answer mode for intercom calls set to one of the following options:

**RING MODE**—The station will ring in one of eight custom ring patterns. Calls are answered by pressing the **ANS/RLS** key or lifting the handset.

**AUTO ANSWER MODE**—After giving a short attention tone, the station will automatically answer calls on the speakerphone. When a C.O. line is transferred to a station in Auto Answer, the screened portion of the call will be Auto Answer, but the keyset will ring when the transfer is complete if the user has not pressed the **ANS/RLS** key or lifted the handset.

**VOICE ANNOUNCE**—The station will not ring. After a short attention tone, callers can make an announcement. The called party must press the **ANS/RLS** key or lift the handset to reply.

### ACTION

1. Press the **transfer key** followed by **103**  
Display shows
2. Dial **0, 1** or **2** to change the ring mode, e.g., **2**  
OR  
Press **UP** or **DOWN** to select the ring mode
3. Press the **transfer key** to store and exit

### DISPLAY

[ 201 ] ANS MODE  
RING MODE

[ 201 ] ANS MODE  
VOICE ANNOUNCE

## 1.6 PROGRAMMING YOUR STATION'S NAME

Names are written using the keypad. Each key press selects a character. Pressing the dial pad key moves the cursor to the next position. For example, if the directory name is "SAM SMITH," press the number "7" four times to get the letter "S." Press the number "2" once to get the letter "A." Continue selecting characters from the table below to complete your message. Pressing the bottom left programmable key will change the letter from upper case to lower case. There are up to 11 characters that can be used.

### NOTES:

1. When the character you want appears on the same dial pad key as the previous character, press the **VOLUME UP** or **DOWN** keys to move the cursor to the right or to the left.
2. When the system is equipped with a Samsung Voicemail System, and your System Administrator has enabled it, changing the station name here will also update the name in your voicemail box.

### • iDCS KEYSETS, ITP KEYSETS, and SMT-i KEYSETS

COUNT	1	2	3	4	5
DIAL 0	<	>	.	)	0
DIAL 1	space	?	,	!	1
DIAL 2	A	B	C	@	2
DIAL 3	D	E	F	#	3
DIAL 4	G	H	I	\$	4
DIAL 5	J	K	L	%	5
DIAL 6	M	N	O	^	6
DIAL 7	P	Q	R	S	7
DIAL 8	T	U	V	*	8
DIAL 9	W	X	Y	Z	9
DIAL *	:	=	[	]	*

The # key can be used for the following special characters: #, space, &, !, :, ;, ?, ., %, \$, -, <, >, /, =, [, ], @, ^, (, ), \_ , +, {, }, |, ;, \, " and ~.

1. When the character you want appears on the same dial pad key as the previous character, press UP to move the cursor one space to the right.
2. Other symbols are available for DIAL #.

## ACTION

1. Press the **transfer key** followed by **104**  
Display shows
2. Enter the station name using the procedure described above
3. Press the **transfer key** to store and exit

## DISPLAY

[ 201 ] STN NAME

[ 201 ] STN NAME  
SAMSUNG

## 1.7 PROGRAMMING PERSONAL SPEED DIAL LOCATIONS

You can program frequently dialed telephone numbers in a personal speed dial list. Each station user begins with ten numbers 00–09 and may be assigned up to fifty numbers. See your system administrator to determine the amount assigned to your station.

NOTE: Press button **B** for flash and button **C** for pause.

Display keyset users may want to hide some speed dial numbers so they will not show in the display. Before entering a telephone number, press button **E**. All digits after this will be hidden. Press button **E** again to begin displaying digits.

If your system uses rotary (or pulse) dialing C.O. lines, pressing button **D** before entering a speed dial will cause all subsequent digits to be sent as DTMF tones until the **D** button is pressed again.

### ACTION

### DISPLAY

1. Press the **transfer key** followed by **105**  
Display shows

[ 201 ] SPEED DIAL  
00: \_

If you have no speed dial bins,  
the display will be as shown

[ 201 ] SPEED DIAL  
SPDBLK NOT EXIST

2. Dial the location number (e.g., **05**)  
OR  
Press **UP** or **DOWN** to select the location  
Press the right soft key to move cursor

[ 201 ] SPEED DIAL  
05: \_

3. Enter the trunk access code (e.g., **9**) followed  
by the number to be dialed (e.g., **4264100**)  
OR  
Press the left soft key to return to step 2

[ 201 ] SPEED DIAL  
05: 9-4264100 \_

4. Press the **F** button to access the next program  
OR  
Press the **transfer key** to save and exit

## 1.8 NAMING YOUR PERSONAL SPEED DIAL LOCATIONS

This program allows a character name to be entered for each personal speed dial location. This name enables the speed dial number to be located when using the directory dial feature. The directory dial feature allows the display keyset user to select a speed dial location by scanning its name. There are up to 11 characters that can be used.

### ACTION

### DISPLAY

1. Press the **transfer key** followed by **106**  
Display shows
2. Dial the speed dial location (e.g., **01**)  
OR  
Use **UP** or **DOWN** to scroll through the location numbers and use the right soft key to move the cursor
3. Enter the location name using the procedure described in [Programming Your Station's Name](#)
4. Press **UP** or **DOWN** to move to the next location  
OR  
Press the **F** key to program speed dial numbers
5. Press the **transfer key** to store and exit

```
[ 201 ] SPEED NAME  
00: _
```

```
[ 201 ] SPEED NAME  
01: _
```

```
[ 201 ] SPEED NAME  
01: SAMSUNG _
```

## 1.9 ADDING EXTENDERS TO KEYS

This program allows you to assign key extenders to make a general access feature key more specific. Some common feature keys that can have extenders are listed below:

FEATURE KEY	DESCRIPTION	EXTENDER
BOSS	Boss and Secretary	1–4
DP	Direct Pickup	Extension or station group number
DS	Direct Station Select	Any extension number
FWRD	Call Forward	0–5
GPIK	Group Pickup	01–20
IG	In/Out of Group	Any group number you are part of
MMPG	Meet Me Page	0–9, *
PAGE	Page	0–9, *
PARK	Park (orbits)	0–9
RP	Ring Plan	1–6 or HOLD for None
SPD	Speed Dial	00–49, 500–999
PMSG	Programmed Message	01–13
DIR	Directory	PERS (1), SYS (2) or STN (3)
VT	Voice Mail Transfer	Voice Mail Group (501–509)
SG	Station Group	Any group number (500–509)

### ACTION

1. Press the **transfer key** followed by **107**  
 Display shows the first station
2. Enter the key number, e.g., **18**  
 OR  
 Use **UP** and **DOWN** to scroll through the keys  
 Use the right soft key to move the cursor  
 OR  
 Press the key to be programmed
3. Dial the extender according to above table  
 Press the right soft key to return to step 2  
 OR  
 Press the **transfer key** to store and exit  
 OR  
 Press the **speaker key** to store and advance to the next program

### DISPLAY

```
[ 201 ] EXT (KTS)
01:CALL1 →
```

```
[ 201 ] EXT (KTS)
18:DS →
```

```
[ 201 ] EXT (KTS)
18:DS →DS207
```

## 1.10 CHECKING STATION STATUS

This program displays the following attributes of a station port. This is a *read only* feature.

0	PORT #	Cabinet 1 Slot 2
1	TYPE	Telephone model
2	PICKUP GROUP	None, 01–10
3	SGR	Station Group Number
4	BOSS-SECR	None, 1–4
5	PAGE	Page Zone (1–4)
6,7,8	COS NO	COS (1–30) per Ring Plan (01–06)
9	TENANT GROUP	1

### ACTION

1. Press the **transfer key** followed by **108**  
Display shows
2. Press **UP** or **DOWN** to view the status items
3. Press the **transfer key** to exit

### DISPLAY

```
[201] STN STATUS  
PORT:C1-S02-P01
```

```
[201] STN STATUS  
TYPE:24B US SET
```



## 1.11 CHANGING YOUR TIME AND DATE DISPLAY

Display keysets will always have the date and time displayed when not in use. You can select from the following display options:

- 0      COUNTRY      Sets overall display format and has two options  
                         0 = ORIENTAL MM/DD DAY HH:MM  
                         1 = WESTERN DAY DD MM HH:MM
  
- 1      CLOCK Sets format of clock display and has two options  
                         0 = 12 HOUR (Displays 1 P.M. as 01:00)  
                         1 = 24 HOUR (Displays 1 P.M. as 13:00)
  
- 2      DISPLAY      Sets format of DAY and MONTH display and has two options  
                         0 = UPPER CASE (Displays Friday as FRI and March as MAR)  
                         1 = LOWER CASE (Displays Friday as Fri and March as Mar)

### ACTION

### DISPLAY

1. Press the **transfer key** followed by **109**  
Display shows
  
2. Press **UP** or **DOWN** to select the display mode  
Press the right soft key to move the cursor
  
3. Press the right soft key to return to step 2  
    OR  
Press the left soft key to return to step 3
  
4. Press the **transfer key** to store and exit

[ 201 ] DAY FORMAT  
COUNTRY : WESTERN

[ 201 ] DAY FORMAT  
COUNTRY : ORIENTAL

## 1.12 SETTING STATION ON/OFF OPTIONS

The OfficeServ 7030 allows the system administrator to set any of the keyset features listed below.

OPTION	NAME	VALUE		DESCRIPTION
00	<b>AUTO HOLD</b>	1	ON	Automatically hold the current caller before accessing another trunk or CALL key.
		0	OFF	Disconnect the current caller before accessing another trunk or CALL key.
01	NOT AVAILABLE IN THE USA			
02	HEADSET USE	1	ON	Enable headset mode operation.
		0	OFF	Enable handset mode operation.
03	HOT KEYPAD	1	ON	Allow dialing from an idle state.
		0	OFF	Require the user to lift the handset or press the speakerphone key before dialing a number.
04	KEY TONE	1	ON	Generate a tone each time a key is pressed on the keyset.
		0	OFF	Disable key tone generation.
05	PAGE REJOIN	1	ON	Connect to an in-process page after disconnecting a caller.
		0	OFF	Connect a page only if the keyset is idle at the beginning of the page.
06	RING PREF.	1	ON	Allow the user to answer calls by lifting the handset or pressing the speakerphone button.
		0	OFF	Require users to press a CALL / DT / DS key in order to answer calls.
07	NOT AVAILABLE IN THE USA			
08	AUTO CAMP-ON	1	ON	Automatically camp-on when calling to a busy station.
		0	OFF	Require the user to manually activate the CAMP-ON feature.
09	NOT AVAILABLE IN THE USA			

OPTION	NAME	VALUE		DESCRIPTION
10	AME PASSCODE	1	ON	Require user to enter their AME password to listen o messages as they are being recorded.
		0	OFF	Messages being recorded will always be audible.
11	DISP SPD NAME	1	ON	Display the Speed Dial bin name instead of the dialed number when calling to a Speed Dial number.
		0	OFF	Display the dialed number when calling to a Speed Dial number.
12	CID REVIEW ALL	1	ON	Store all calls in the CID Review block.
		0	OFF	Store only missed calls in the CID Review block.
13	SECURE OHVA	1	ON	Receive Off-Hook Voice Announce (OHVA) audio through the handset.
		0	OFF	Receive OHVA audio through the speakerphone.
14	NOT AVAILABLE IN THE USA			
15	AUTO ANS CO	1	ON	Automatically answer CO calls when the keyset is set for AUTO ANSWER MODE in <a href="#">MMC 103</a> .
		0	OFF	Do not automatically answer CO calls regardless of AUTO ANSWER MODE setting in <a href="#">MMC 103</a> .
16	ENBLOCK 2LCD <i>Only Affects 2-Line Display IP Phones</i>	1	ON	Require the user to press SEND to dial the call when 2 LINE ENBLOCK is set to ENABLE in <a href="#">MMC 861</a> .
		0	OFF	Dial calls soon as digits are entered.
17	STN NO RING	1	ON	Do not ring on incoming calls, only flash the CALL / DT / DS button.
		0	OFF	On incoming calls ring and flash the CALL / DT / DS button.
18	FEATURE TONE	1	ON	Change dial tone to a higher pitch to indicate that a phone status feature is active (DND, Forward All, Station Lock, etc).
		0	OFF	Disable status feature activation notification tone.
19	RCV GPU INFO	1	ON	Generate a short burst of ring tone when a call rings at another member of the pickup group when PINGRING SERVICE is set to ENABLE in <a href="#">MMC 861</a> .

OPTION	NAME	VALUE		DESCRIPTION
		0	OFF	Do not ring when another member of the pickup group receives a call.
20	MISSED CALLS <i>Only Affects 2-Line Display Phones</i>	1	ON	Display a notification of missed calls including number of missed calls and the CID of the most recent call missed.
		0	OFF	Do not display missed calls notification screen.
21	NOT AVAILABLE IN THE USA			
22	USE STN RING <i>Only Affects Large Display IP Phones</i>	1	ON	Allow the user to select a ringtone stored in the keyset instead of a system-generated ringtone.
		0	OFF	Limit ringtone selections to system-generated ringtones found in <a href="#">MMC 111</a> .
23	NOT AVAILABLE IN THE USA			
24	NOT AVAILABLE IN THE USA			

**ACTION**

Press TRANSFER 110  
 Display shows

**DISPLAY**

**[201] STN ON/OFF**  
**AUTO HOLD :OFF**

## 1.13 SELECTING A RING TONE

Each keyset user can select one of eight ring frequencies.

### ACTION

1. Press the **transfer key** followed by **111**  
Display shows
2. Dial **1–8** to select the ring tone  
OR  
Press **UP** or **DOWN** to select the ring tone  
Press the right soft key to move the cursor
3. Press the **transfer key** to store and exit

### DISPLAY

[ 201 ] RING TONE  
SELECTION 6

[ 201 ] RING TONE  
SELECTION 5

## 1.14 ALARM REMINDER

Station users can have three alarms programmed at their phones. Each alarm may be one of the following three types:

- 0. NOTSET                      The alarm is not set.
- 1. TODAY ONLY                The alarm will ring at the programmed time and be canceled automatically.
- 2. DAILY                        The alarm will ring each day at this time.

### IMPORTANT NOTE

On the SMT-i5200 Series phones this feature is handled by the local phone. It cannot be programmed through the phone system and it will show as feature not permitted.

#### ACTION

1. Press the **transfer key** followed by **112**  
Display shows
2. Dial **1-3** to select the alarm (e.g., **2**)  
OR  
Press **UP** or **DOWN** to select alarm  
Press the right soft key to move the cursor  
OR  
Press the left soft key to return to step 2
3. Enter alarm time in 24 hour format (e.g., **1300**)  
Display automatically advances to step 5
4. Enter alarm type (e.g., **2**)  
OR  
Press **UP** or **DOWN** to select alarm type  
Press the right soft key to move the cursor  
and return to step 2
5. Press the **transfer key** to store and exit

#### DISPLAY

[ 201 ] ALM CLK (1)  
HHMM: →NOTSET

[ 201 ] ALM CLK (2)  
HHMM: →NOTSET

[ 201 ] ALM CLK (2)  
HHMM: 1300→NOTSET

[ 201 ] ALM CLK  
HHMM: 1300→DAILY

## 1.15 STATION VOLUME

This procedure allows users to view and set the level of the volume for your keyset.

- 0. RING VOLUME      Set a level for your keyset ring volume. There are eight levels of volume; level 1 is the lowest and level 8 is the highest.
- 1. OFF-RING VOL      Set a level for your keyset off-hook ring volume. There are eight levels of volume; level 1 is the lowest and level 8 is the highest.
- 2. HANDSET VOL      Set a level for your keyset handset volume. There are eight levels of volume; level 1 is the lowest and level 8 is the highest.
- 3. SPEAKER VOL      Set a level for your keyset speaker volume. There are sixteen levels of volume; level 1 is the lowest and level 16 is the highest.
- 4. BGM VOLUME      Set a level for your keyset background music volume. There are sixteen levels of volume; level 1 is the lowest and level 16 is the highest.
- 5. PAGE VOLUME      This is the volume you will hear internal page over the keyset speaker when your keyset is idle and BGM is turned on. There are 16 volume levels: level 1 is the lowest and level 16 the highest.

### ACTION

### DISPLAY

- 1. Press the **transfer key** followed by **114**  
 Display shows
- 2. Dial **1-8** to select the volume to change  
 OR  
 Press **UP** or **DOWN** to select the volume to change  
 Press the right soft key to move the cursor
- 3. Press UP or DOWN to select ON or OFF  
 Press the left or right soft key to return to step 2  
 OR  
 Dial **1** for ON or **0** for OFF

[ 201 ] STN VOLUME  
RING VOLUME : OFF

[ 201 ] STN VOLUME  
OFF-RING VOL : OFF

[ 201 ] STN VOLUME  
OFF-RING VOL : ON

If option 0 from above list is dialed at step 2

[ 201 ] STN VOLUME  
 RING VOLUME : 4

If option 1 from above list is dialed at step 2

[ 201 ] STN VOLUME  
 OFF-RING VOL : 4

If option 2 from above list is dialed at step 2

[201] STN VOLUME  
HANDSET VOL: 4

If option 3 from above list is dialed at step 2

[201] STN VOLUME  
SPEAKER VOL: 13

If option 4 from above list is dialed at step 2

[201] STN VOLUME  
BGM VOLUME : 13

4. Press the **transfer key** to store and exit



## 1.16 SETTING A PROGRAMMED MESSAGE

When you will be away from your phone for any length of time, you can leave a programmed message. Display stations calling you will see this message and be informed of your status or follow your instructions.

### ACTION

1. Press the **transfer key** followed by **115**  
Display shows
2. Dial **00-20** to select message number, e.g., **05**  
OR  
Press **UP** or **DOWN** to select message
3. Press the left or right soft key to return to step 2  
OR  
Press the **transfer key** to store and exit

### DISPLAY

```
[ 201 ] PGMSG ( 00 )  
CANCEL VAC MSG
```

```
[ 201 ] PGMSG ( 05 )  
PAGE ME
```

## 1.17 ALARM REMINDER WITH MESSAGE

Station users can have three alarms programmed at their phones. Each alarm may be one of the following three types:

- 0. NOTSET                      The alarm is not set.
- 1. TODAY ONLY                The alarm will ring at the programmed time and be canceled automatically.
- 2. DAILY                        The alarm will ring each day at this time.

In addition, each alarm may be accompanied by a 16 character message that will be displayed while the alarm is ringing.

NOTE: These are the same three alarms described in [Alarm Reminder](#). This procedure allows a message to be added. A display keyset is necessary to view messages.

**IMPORTANT NOTE**

On the SMT-i5200 Series phones this feature is handled by the local phone. It cannot be programmed through the phone system and it will show as feature not permitted.

### ACTION

### DISPLAY

1. Press the **transfer key** followed by **116**  
 Display shows
2. Dial **1-3** to select the alarm (e.g., **2**)  
 OR  
 Press **UP** or **DOWN** to select the alarm  
 Press the right soft key to move the cursor
3. Enter the alarm time in 24 hour clock format (e.g., **1300**)  
 Display automatically advances to step 4
4. Dial the valid entry from the above list for the alarm type  
 OR  
 Press **UP** or **DOWN** to select the alarm type  
 Press the right soft key to move the cursor
5. Enter messages using the method in [Programming Your Station's Name](#)  
 Press the right soft key to return to step 2
6. Press the **transfer key** to store and exit

[ 201 ] ALM REM ( 1 )  
 HHMM: →NOTSET

[ 201 ] ALM REM ( 1 )  
 HHMM: →NOTSET

[ 201 ] ALM REM ( 2 )  
 HHMM: 1300→NOTSET

[ 201 ] ALM REM  
 HHMM: 1300→DAILY

[ 201 ] ALM REM  
 TAKE MEDICATION

## 1.18 CALLER ID DISPLAY

The station user can change the order in which the CLI, Caller ID and/or ANI information is displayed on an LCD set during a transferred call.

CLI display options are the following:

- |                 |  |
|-----------------|--|
| 0. NO DISPLAY   | No CLI data will be displayed.   |
| 1. NUMBER FIRST | The CLI number received from the Central Office will be displayed first. |
| 2. NAME FIRST   | The CLI name received from the Central Office will be displayed first.   |

Caller ID display options are the following:

- |                 |  |
|-----------------|--|
| 0. NO DISPLAY   | No CID data will be displayed.   |
| 1. NUMBER FIRST | The CID number received from the Central Office will be displayed first. |
| 2. NAME FIRST   | The CID name received from the Central Office will be displayed first.   |

ANI display options are the following:

- |                 |  |
|-----------------|--|
| 0. NO DISPLAY   | No ANI data will be displayed.   |
| 1. NUMBER FIRST | The ANI number received from the Central Office will be displayed first.   |
| 2. NAME FIRST   | Since there is no name sent by the Central Office, The only time you will receive a name is when your service company has programmed a name to be associated with the number otherwise your display will read "no ANI name". |

### ACTION

1. Press the **transfer key** followed by **119**  
Display shows

### DISPLAY

[ 201 ] C ID DISP  
NUMBER FIRST

2. Dial **0** or **1** to select CID or ANI  
OR  
Press **UP** or **DOWN** to select CID or ANI and press  
the right soft key

[201] ANI DISP  
NUMBER FIRST

3. Dial display option **0**, **1** or **2**, e.g., **2**  
OR  
Press **UP** or **DOWN** to select option

[201] CID DISP  
NAME FIRST

4. Press the **transfer key** to store and exit

**OfficeServ™**  
**SMT-i5243**



USER GUIDE



**OfficeServ™ SMT-i5243**  
Keyset User Guide

*For OfficeServ™ 7000 Series Systems*

# TABLE OF CONTENTS

<b>ABOUT THIS BOOK</b> .....	1
<b>SECTION 1. CAUTION AND PREPARATION</b> .....	2
<b>CAUTION</b> .....	3
<b>PREPARATION</b> .....	4
Check the Contents of the Box .....	4
Phone Installation .....	4-5
Optional Equipment.....	5-6
<b>SECTION 2. PHONE FUNCTIONS</b> .....	7
<b>SMT-i5243 LAYOUT</b> .....	8
Names and Functions .....	8-9
<b>KEY FUNCTIONS</b> .....	10
Telephone Status Indicator .....	10
Screen Structure .....	10
Text Input Method .....	11
Description of Icons .....	12
Calling Status Information.....	13
Navigating the Menus.....	13
Navigation Button and Select Switch for FWD/DND/Absent MSG .....	13
<b>SMT-i5243 SETUP</b> .....	15
Initializing the SMT-i5243 .....	15
Setup Mode .....	15
Easy Install Wizard .....	15
Setting IP Manually .....	16
Setting Up Extension Login .....	16
Configuration Menu Structure.....	17
<b>SECTION 3. FREQUENTLY USED</b>	
<b>FEATURE OPERATION</b> .....	18
<b>EXTENSION LOG IN &amp; OUT</b> .....	19
<b>PLACING CALLS</b> .....	19
<b>ANSWERING CALLS</b> .....	21
<b>PLACING A CALL ON HOLD</b> .....	21
<b>TRANSFERRING CALLS</b> .....	21

Copyright 2010 Samsung Telecommunications America.

All rights reserved. No part of this manual may be reproduced in any form or by any means—graphic, electronic or mechanical, including recording, taping, photocopying or information retrieval systems—without express written permission of the publisher of this material.

Samsung Telecommunications America reserves the right without prior notice to revise information in this guide for any reason. Samsung Telecommunications America also reserves the right without prior notice to make changes in design or components of equipment as engineering and manufacturing may warrant. Samsung Telecommunications America disclaims all liabilities for damages arising from the erroneous interpretation or use of information presented in this guide.

<b>TRANSFERRING WITH CAMP-ON</b> .....	22
<b>CALL WAITING</b> .....	22
<b>CONFERENCE CALLS</b> .....	22
<b>FORWARDING CALLS</b> .....	23
<b>OTHER FEATURES AND FUNCTIONS</b> .....	23-26
<b>LCR POWER SAVING FEATURE</b> .....	27
<b>SECTION 4. PHONE FEATURES</b> .....	28
<b>BASIC MENUS</b> .....	29
Soft Button Structure .....	29
Call Menus .....	30
Service Soft Button .....	38
Phone Soft Button .....	38
Setting Soft Button .....	39
Func. Soft Button .....	40
AOM Soft Button .....	40
<b>SECTION 5. OFFICESERV 7000 SYSTEM FEATURES</b> .....	41
<b>OUTSIDE CALLS</b> .....	42
Making Calls from AOM .....	42
Universal Answer .....	42
Recall Dial Tone .....	42
Sending a Flash .....	42
Busy Line Queuing with Callback .....	42
Busy Station Callback .....	43
Canceling Callback .....	43
Busy Station Camp-On .....	43
<b>INTERCOM CALLS</b> .....	45
Voice Announce Mode .....	45
Auto Answer Mode .....	45
Calling your System Operator .....	45
<b>CALL PROCESSING</b> .....	46
System Hold .....	46
Exclusive Hold .....	46
Remote Hold .....	46
Hold Recall .....	47
Consultation Hold .....	47
Retrieving Calls Held at Another Station .....	47
Call Transfer .....	48

Transfer with Camp-On .....	48
Transfer to Voice Mail .....	49
Call Waiting .....	49
Call Forward Options .....	49
Station Call Pickup .....	50
Group Call Pickup .....	51
My Group Pickup .....	51
Privacy Release .....	51
<b>DIALING FEATURES</b> .....	52
Speed Dialing .....	52
Programming Personal Speed Dial Numbers .....	52
Directory Dialing .....	53
Last Number Redial .....	54
Save Number with Redial .....	54
Automatic Redial/Retry .....	54
Pulse to Tone Changeover .....	54
<b>PAGING AND MESSAGING</b> .....	55
Making and Internal Page .....	55
Making an External Page .....	55
All Page .....	55
Meet Me Page .....	56
Call Park and Page .....	56
Messages—Set and Cancel .....	57-58
Returning Messages .....	58
Programmed Messages .....	58
<b>CONVENIENCE FEATURES</b> .....	59
Logging In and Out .....	59
Do Not Disturb .....	59
One Time DND .....	59
Mute .....	60
Background Music .....	60
Established Call Pick-Up .....	60
Door Phone Calls .....	60-61
Executive/Secretary Hotline .....	61
Group Listening .....	62
Account Codes .....	62
Locking Your Keypad .....	63
Manual Signalling .....	63
Off-Hook Voice Announce .....	64
OHVA Block .....	64

OHVA Reject .....	64	Listen to your Messages .....	82
In Group/Out of Group.....	65	Subscriber Services Menu .....	82
<b>CUSTOMIZING YOUR KEYSSET</b> .....	66	Listening to Old or New Messages .....	83
AME Password .....	66	Group New or Old Messages .....	84
Auto Camp-On .....	66	Record and Send a Message .....	84
Select Ring Tone .....	66	Access Manager .....	86
Change Your Passcode .....	66	Personal Greetings.....	87
Set Answer Mode (Intercom) .....	67	Mailbox Administration .....	90
Set Answer Mode (CO) .....	67	Message Broadcast .....	92
Automatic Hold.....	67	Personal Services .....	92
Headset Operation.....	67	Personal Administration Settings .....	93
Hot Keypad .....	68	Keypad User Features .....	94
Key Confirmation Tone.....	68	Shortcuts .....	96
Rejoining a Page.....	68	Interactive Displays .....	96
Ring Preference.....	68	E-Mail Gateway (EMG).....	96–98
Display Speed Dial Name .....	69	<b>USB PORT</b> .....	99
Caller ID Review All .....	69	Setting Up a Bluetooth Headset.....	99
Secure OHVA .....	69	Setting Up a Video Camera .....	101
Configure Mobile Extensions (MOBEX) .....	69–70	Flash USB Memory Stick .....	102
<b>DISPLAY FEATURES</b> .....	71	External USB Port Specifications .....	102–103
Directory Information .....	71	<b>PERSONAL SPEED DIAL NUMBERS</b> .....	104–105
Display Number Dialed .....	71		
Call Duration Timer .....	71		
Auto Timer .....	71		
Timer Function .....	72		
Viewing Station Message Indications.....	72		
Station Names .....	72		
Personal Speed Dial Names .....	72		
Station Names .....	72		
Managing Programmable Key Assignments .....	73		
Backspace with LCR.....	73		
<b>CALLER ID</b> .....	74		
Selecting Your Caller ID Display .....	74		
Viewing the Next Caller ID Call .....	75		
Inquire Caller ID Park/Hold Info .....	75		
<b>FEATURE ACCESS CODES</b> .....	76		
<b>SECTION 6. APPLICATIONS</b> .....	77		
<b>SAMSUNG VOICEMAIL</b> .....	78		
Accessing Your Mailbox .....	79		
SVMi E-Series Subscriber Services Menu Diagram .....	80–81		
Getting Started .....	82		



## ABOUT THIS BOOK

The new Samsung Multimedia Telephone SMT-i5243 keyset is part of the OfficeServ 7000 Series.

The SMT-i5243 keyset represents a new concept of Internet phone, in that it uses an IP address to Send/Receive voice and data. For voice communications, the SMT-i5243 uses the data network line already in place in most offices and increasing number of homes.

This guide contains 6 sections: Section 1. Caution and Preparation, Section 2. Phone Functions, Section 3. Frequently Used Feature Operation, Section 4. Phone Features, 5. OfficeServ 7000 System Features, and Section 6. Applications. Please take the time to study this guide and to become familiar with the operation of your keyset. Keep this guide handy, as you may need to look up instructions for infrequently used features.

This book is written based on factory default settings, for the feature access codes. Sometimes, due to programming requirements, these codes may be changed. If you find that a feature code does not work as described in this book, please contact your installation and service company to determine the correct code.

## CAUTION

# SECTION 1. CAUTION AND PREPARATION

- Read the installation instructions before connecting the system to its power source.
- If there is dirt or moisture on the pin contact surface of a power plug, pull out the plug and wipe it away with a cloth. If dirt or moisture remains on the product even after wiping, contact the service center.
- For the power connection port of the phone, use the supplied power adapter. (The power adapter is supplied separately.) Use of a power adapter that does not meet the specifications may cause the product to become damaged, to overheat, or to explode.
- Do not place the phone in a location with a lot of dust, in a location that is subject to severe changes in temperature, or near a heating device (cigarette heat, heater, etc.)
- Do not use or store flammable spray or materials near the phone.
- Do not place vases, flowerpots, cups, or a container of cosmetics or drugs near the phone.
- Installation of equipment must not route interconnecting cables or external power supply sources outdoors.
- The LAN cable to the network should be connected to the LAN port of a phone, NOT to the PC connection port.
- Use a soft and dry cloth when cleaning the phone. Do not spray water directly onto the product; and do not use chemicals such as wax, benzene, alcohol, thinner, mosquito killer, perfume spray, lubricant, detergent, etc.

# PREPARATION

## CHECK THE CONTENTS OF THE BOX

Check if the product package box includes all the components as follows:

- Phone body including a base
- Handset
- Handset cord
- Patch cable

**NOTE:** Power adapter sold separately. If any of these items are missing or damaged, please contact your dealer.

## PHONE INSTALLATION

### Connecting the Phone Body

Remove the base of the phone by pressing the **[Push]** mark on the top of the base.

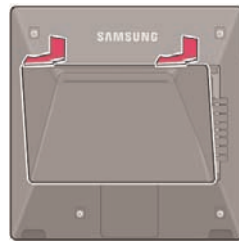

Note: The base can be used to adjust the phone angle in the high or low position.

- 1 Connect a handset to the handset port on the back of the phone.
- 2 Disconnect the Ethernet cable from the computer, and attach it to the PC port on the back of your IP phone.
- 3 Connect the Ethernet port in your workspace to the LAN port on the back of your phone, using the provided LAN (UTP) cable. Your IP phone now shares a network connection with your computer.
- 4 Connect a standard power outlet in your workspace to the power port using the AC power adapter. The phone will subsequently boot. If your system administrator delivered your phone without a power supply, your phone probably receives power through the Ethernet connection.
- 5 To use a headset, connect the headset to the headset port on the back of your phone.

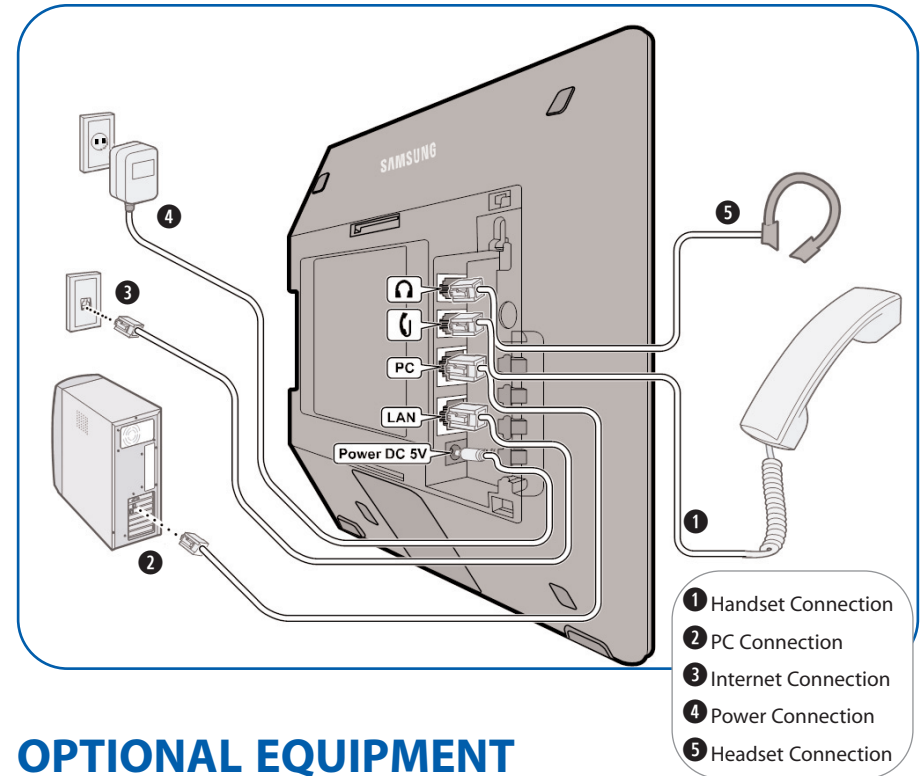

## OPTIONAL EQUIPMENT

### SMT-i5264 [ADD-ON MODULE]

The **SMT-i5264** IP AOM can be registered and programmed to function with any ITP 5100 keysets, SMT-i Series, and TDM phones. This add-on module was cosmetically designed to match the SMT-i5000 Series phones. In some applications multiple IP AOMs can be supported per IP phone. *For installation instructions, see your System Administrator.*

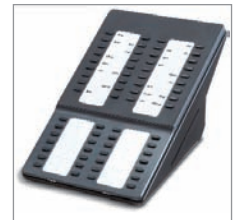

### SMT-A52GE [GIGABIT ADAPTER]

The **SMT-A52GE** Gigabit Adapter processes the Gigabit data for a Gigabit LAN connection on the PC connected to the SMT-i5200 Series IP phones. The SMT-A52GE can be installed to function with any of the SMT-i5200 Series IP phones. *For installation instructions, see your System Administrator.*



## WALL MOUNT BRACKET

An optional bracket is available for wall mounting the SMT-i5200 Series phones to the wall. *For installation instructions, see your System Administrator.*

## SMT-A53PW [POWER ADAPTER]

The power adapter is sold separately.

### CAUTION

The input power of the SMT-i5243 needs 5.0vDC and 3000mA. The SMT-i5243 phone needs to be powered by using Samsung's SMT-A53PW power adapter. Failure to use the appropriate power supply will cause permanent damage to the phone and will void Samsung's warranty.

## SECTION 2. PHONE FUNCTIONS

# SMT-i5243 LAYOUT

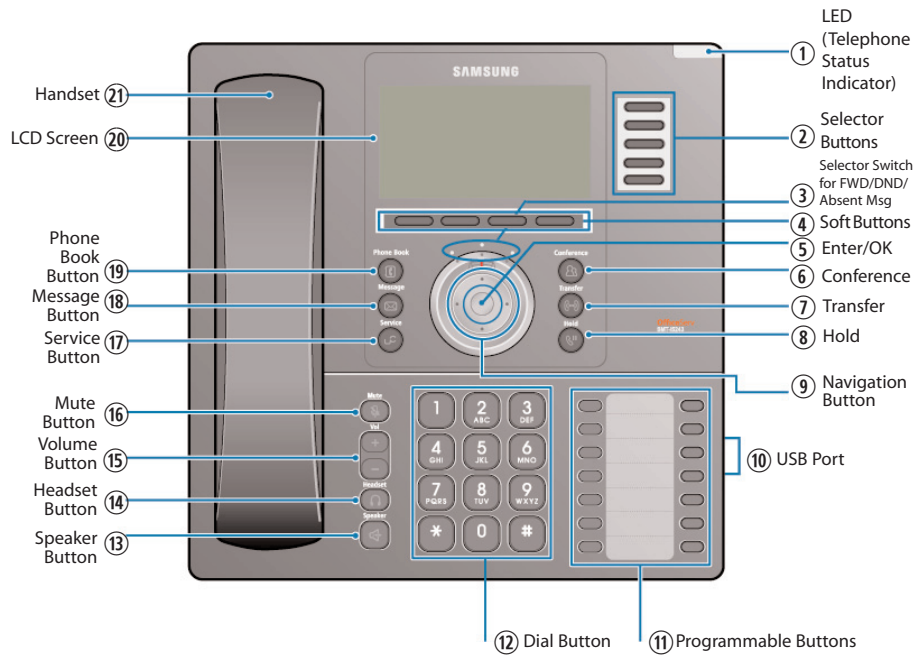

**NOTE:** The words “key” and “button” are interchangeable.

## NAMES AND FUNCTIONS

Button	Function
① LED (TSI)	The blinking pattern differs depending on the phone status (Telephone Status Indicator).
② Selector Buttons	Used to select the desired function from the soft menus displayed at the right of the LCD screen.
③ Selector Switch for FWD/DND/Absent Msg	Used to select or deselect the <b>Call Forwarding/DND/Absent Message</b> setting by using the Selector Switch control.
④ Soft Buttons	Used to select the desired function from the soft menus displayed at the bottom of the LCD screen.
⑤ Enter/OK	Used to make selection or to save an entry.
⑥ Conference Button	Used for conference calls.
⑦ Transfer Button	Used to enable the call transfer function.
⑧ Hold Button	Used to place a call on hold.

Button	Function
⑨ Navigation Button	Used to move the display cursor up and down, left and right on certain menus.
⑩ USB Port	Supports Web video camera, Bluetooth® dongle (to connect Bluetooth headset), and USB memory stick (up to 4 GB) used for phonebook upload and download, and software upgrade.
⑪ Programmable Buttons	5 desileless buttons used to set up and label function buttons on the phone.
⑫ Dial Button	Used to dial the phone number.
⑬ Speaker Button	Used to enable/disable the use of a speaker phone.
⑭ Headset Button	Used to activate and deactivate the headset jack.
⑮ Volume Button	Used to control the volume settings.
⑯ Mute Button	Used to silence the transmit voice to the remote party.
⑰ Service Button	For use with the Unified Communicator Server (optional)
⑱ Message Button	Used to access all the messaging options: Voicemail Messages, Station Messages, SMS, and E-Mail Messages.
⑲ Phone Book Button	Used to search for a phone number saved in the phone, or to register a new number. Pressing this button shows the main screen of the phone book. Used to move downward on various list screens.
⑳ LCD Screen	A backlit display showing the phone's status (busy, ringing, receiving an internal message, etc.)
㉑ Handset	Used for two-way voice conversation.

# KEY FUNCTIONS

**NETWORK:** The SMT-i5243 uses VoIP communication through an already-installed data network.

**LCD SCREEN:** Various functions are displayed on the LCD screen, so you can use them conveniently by using the **Navigation** buttons on the phone.

**SHORT MESSAGE SERVICE (SMS):** You can exchange text messages using this function. This function is available on internal IP stations.

## TELEPHONE STATUS INDICATOR

The indicators are turned on or off depending on the status of relevant functions.

Screen	Status	LED Indicator
	When station is busy	Red colored indicator is constant.
	When station is receiving an incoming call	Red indicator (slow flash).
	When there is a message	
	During "Do Not Disturb"	Red indicator (fast flash).
	Incoming Trunk Call	Green colored indicator flashes.
	Hold Recalls	Amber colored indicator flashes.

## SCREEN STRUCTURE

The LCD screen consists of three areas.



- **STATUS DISPLAY:** On the top of the screen, the icons representing phone function settings are displayed.
- **MAIN SCREEN:** On the main screen, selectable menus, call processing status, and various messages are displayed.
- **MENU DISPLAY:** At the bottom of the screen, menus that the user can select depending on status are displayed.

## TEXT INPUT METHOD

Using the dial and direction buttons on the phone, you can enter and modify the English characters, numeric and special characters.

Whenever you press the dial button [\*] on a text input screen, the input mode is changed in sequence.

### Text Input Example

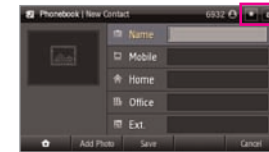

- A** Uppercase Input Mode
- a** Lowercase Input Mode
- 123** Numeric Input Mode
- #** Special Character Input Mode

- Use the dial buttons to type English text and numbers; and use the **Navigation** button to move the cursor left and right and **OK** buttons to complete input. When removing the typed characters, select the **Del** soft button.

**English Input:** Select this mode (uppercase/lowercase) by pressing the [\*] button, and type text by repeated pressing the dial buttons.

**Number Input:** Select this mode by pressing the [\*] button, and type numbers by pressing the dial buttons.

**Special Character Input:** Select this mode by pressing the [#] button; select a desired character by using the **Navigation** button; and press the **OK** button to enter it.

### Keypad Character Entry

Count	1	2	3	4
<b>Dial *</b>	A (Uppercase)	a (Lowercase)	1 (Numbers)	\$ (Special Characters)
<b>Dial #</b>	Not Used			
<b>Dial 0</b>	Not Used			
<b>Dial 1</b>	Not Used			
<b>Dial 2</b>	A	B	C	
<b>Dial 3</b>	D	E	F	
<b>Dial 4</b>	G	H	I	
<b>Dial 5</b>	J	K	L	
<b>Dial 6</b>	M	N	O	
<b>Dial 7</b>	P	Q	R	S
<b>Dial 8</b>	T	U	V	
<b>Dial 9</b>	W	X	Y	Z

## DESCRIPTION OF ICONS

The following icons are displayed on the screen.

Icon	Description
	Shows that 'Call Forward' is enabled.
	Shows that 'Do Not Disturb' is enabled.
	Appears when there are unread <b>Short Messages</b> in the message inbox. Once they are read, it disappears.
	Internal Station Messages.
	Station Locked.
	Recording during calling.
	Bluetooth dongle connection and bluetooth headset registration status.
	Photo icon.
	Shows that a LAN cable is <b>connected</b> to the <b>PC port</b> .
	Shows that a <b>LAN cable</b> is connected to the LAN port but that the system is <b>not connected</b> .
	Shows that a <b>LAN cable</b> is <b>connected</b> to the LAN port and that the system is connected normally.
	<b>Outgoing</b> Call icon in Call Log.
	<b>Incoming</b> Call icon in Call Log.
	<b>Missed</b> Call icon.
	Appears when there is an <b>IP connection</b> .
	Appears when the <b>Headset</b> button is active.
	Shows when there is a <b>Cell phone</b> number for the entry in the Phone Book.
	Shows when there is a <b>Home phone</b> number for the entry in the Phone Book.
	Shows when there is a <b>Office phone</b> number for the entry in the Phone Book.
	Shows when there is an internal <b>Extension</b> number for the entry in the Phone Book.

## CALLING STATUS INFORMATION

Describes the different animation images displayed according to call status.

ANIMATION IMAGE	DESCRIPTION
	Dial input/system function is being conducted.
	A call is being made.
	Busy status.
	A secret call is being made.
	A call is being received.
	Call end (displayed when a call ends and the phone is in an off-hook status).
	Call recording.

## NAVIGATING THE MENUS

When programming within various menu options, information can be entered via the dial pad keys using [0]-[9] and [\*] dial keys. The button used for editing and their features are summarized below.

BUTTONS	FEATURES
<b>Volume + and -</b>	To move the cursor left and right, up and down.
<b>Hold</b>	To clear/delete an entire field such as station name.
<b>Transfer</b>	To write the changes and exit programming.

## NAVIGATION BUTTON and SELECTOR SWITCH FOR FWD/DND/ABSENT MSG

The SMT-i5243 phone has a navigation button and a Selector Switch for FWD/DND/Absent Message to allow users to use its functions easily.

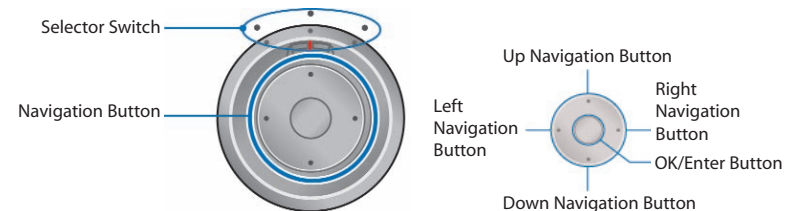

The Selector Switch can be used to manually set and cancel station Call Forwarding and Do Not Disturb. **NOTE:** Do not use the access codes or the func-

tion menu to cancel FWD/DND when the selector switch is set in the left or right position because the switch takes precedence over the access codes/function menu.

BUTTON		FUNCTION
<b>Selector Switch</b>	Left	Users can set the phone to the call forward state.
	Center	The default standby status. (Normal Mode)
	Right	This is set to "Do Not Disturb" or "Absent Message Status".
<b>Navigation</b>	Direction Key	Users can edit the contents on the screen or move between menu items.
	OK/Enter	Users can select or save the item where a cursor is placed in a menu mode. Users can check the caller information received from a station line during receiving.

# SMT-i5243 SETUP

## INITIALIZING THE SMT-i5243

Initially the SMT-i5243 IP keyset will need to be setup to operate within the users network. The Setup Menu is also used to make changes to the keyset, in the event that the system information should change. The option chosen will be highlighted.

The station numbers will be automatically set by the OfficeServ 7000 Series systems once the necessary information has been entered into the IP keyset. Enter ID and password of the server, as described below to register the phone.

See your system administrator for specific Network and Server addresses. The addresses necessary to set up the SMT-i5243 are:

- IP Address of Station
- Network Gateway Address
- IP Address of System's main processor
- User ID
- Password

## SETUP MODE [EXAMPLE OF SETTING MANUAL IP]

To set up the phone, power up the phone and wait for it to boot up. After booting up, the display will show **Easy Install Menu**.

## EASY INSTALL WIZARD

- On [1. **Start Easy Install**] screen, make sure the network cable is connected to the LAN port of the phone and then press the **Next** soft button.
- On [2. **Setting Language**] screen, select the language and KeyPad Type and press the **Next** soft button.
- On [3. **Setting Register Server**] screen, set the **Server IP** (the phone system's IP address 192.xxx.x.200).
- Enter the station **ID** (example 3205). Enter the **password** (example 1234).
- Enter **Server type** OfficeServ (default); then press the **Next** Soft button.





## SETTING IP MANUALLY

- On [4. **Setting Network Information**] screen, set the **Network Mode** (example Static). Enter the station **IP address** (192.xxx.x.195), **Gateway** (192.xxx.x.1), and **Subnet mask** (255.255.255.0).
- Press **Next** soft button to skip [5. **Setting VLAN**].
- Press **Next** soft button to skip [6. **Setting 802.1x**].
- Press the **Done** soft button to complete the setup.
- Press the **Yes** soft button the complete the installation and reboot the phone.

## SETTING UP EXTENSION LOGIN [HOT DESKING]

Hot Desking allows you to log in and out of your SMT-i5243 IP keyset without rebooting.

- Press the **Menu** soft button, scroll to **Phone** soft button.
- Scroll to **Phone Information** and press **OK** button.
- Enter the administrator's password (please contact your phone system administrator).
- Scroll to **Extension Login** then press **OK** button.
- Choose the **ON** option and press **OK** button. (Note: **ON** to allow, **OFF** to deny hot desking).
- Press the **OK** button then **Save** soft button to complete the setup.
- When the phone restarts, enter the **ID** (eg; extension 2809) and **password**.
- Press the **Login** soft button to complete the login.

## CONFIGURATION MENU STRUCTURE

This menu is for administrator use and requires a password. The **Configuration Menu** options are as follows:

### 1. EASY INSTALL

This option will guide you through setting up all required parameters for connecting the SMT keyset to your system.

### 2. PHONE INFORMATION

1. Version Info: Provides boot rom, software, DSP, and hardware version information.
2. Network Info: Displays network mode, IP address of phone, network, and gateway information.
3. MAC Address

### 3. NETWORK

Displays Static IP, Dynamic IP, PPPoE, NAT, 802.1x, VLAN (LAN), and VLAN (PC).

### 4. SERVER

1. Primary System: The main processor's IP address.
2. System 1~3: Up to 4 server IPs can be set.

### 5. EXTENSION LOGIN

Allows the user to choose the option of permitting the phone either login/logout from idle mode or only register to the server on power up. Once the phone is placed into Extension Login mode, a display will show up to allow you to enter any valid User ID and password. This function is also referred to as hot desking (idle login).

### 6. VIDEO OPTION (OPTIONAL)

This option is used to set video parameters for using video phone features or video services. This feature is optional.

### 7. SOFTWARE UPGRADE

One of the following methods can be used HTTP, TFTP, and USB.

### 8. FACTORY RESET

This option resets the SMT-i5243 to factory default settings.

### 9. PHONE RESTART

This option reboots the SMT-i5243 phone.

## SECTION 3. FREQUENTLY USED FEATURE OPERATION

This section provides the basic operation of your Samsung Multimedia Telephone **SMT-i5243**.

### EXTENSION LOG IN & OUT [HOT DESKING]

If enabled, your SMT-i5243 telephone may require you to log in before making or receiving calls. In these cases your telephone system administrator will provide you with an extension number, password, and the feature code used to log out.

#### TO LOG IN

- Dial your **extension number** in the Server ID field.
- Use the **Navigation** button to move down to the Password field.
- Dial your **password** in the password field (example 1234).
- Press **Login** soft button.

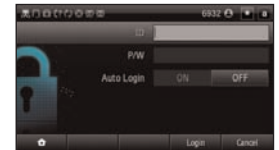

#### TO LOG OUT

- Dial the feature code provided by your administrator (for example 77).

### PLACING CALLS

**IMPORTANT:** Put your phone in **Normal (Overlap) Mode** by pressing the **Menu** button, select **Settings** soft button and then select **Application Settings**, press **OK**, select **Call**, press **OK**, scroll to **Dial Mode**, change it to **Normal (Overlap) Mode** by using the **Navigation** Button. If your phone is in **Mobile Phone mode** (Enbloc) you must always press the **Call** soft button after dialing the digits to send the call.

**NOTE:** All examples of making phone calls are based on the phone being set for overlap dialing mode.

**OUTSIDE CALLS** - To place a call to an outside party:

- Lift the handset.
- Press an idle outside line button, line group button, or dial a line access code to receive dial tone.
- Dial the telephone number.
- Hang up the handset when the call is completed.

**NOTE:** Frequently called telephone numbers can be added to the PhoneBook.

When making internal and external calls from AOM (programmable buttons) list, press the **AOM** soft button to access the programmable button screens. Then use the **Navigation** button to scroll to and highlight the desired programmable button. Press **OK** to complete the call.

**INTERNAL CALLS** - To place a call to another extension at your location:

- Lift the handset.
- Dial the extension number or group number.
- Wait for the party to answer. If you hear a brief tone burst instead of ringback tone, the station called is set for Voice Announce or Auto Answer. Begin speaking after the tone.
- Hang up the handset when the call is completed.

**NOTES:**

1. If you have a **DSS** button assigned to an extension or station group, you may press this button instead of dialing the number.
2. If the Hot Keypad feature has been turned off, you must first lift the handset or press the **Speaker** button before you begin dialing.

**SPEAKERPHONE CALLS** - Your Samsung SMT-i5243 has full-duplex speakerphone capability. This feature is used for both internal or external calls. To activate this feature:

- Press the **Speaker** button.
- Place an internal or external call.
- Press **Speaker** button to disconnect the call.

**NOTE:** The handset can be used at any time during the conversation. To resume handsfree operation, press the **Speaker** button, and hang up the handset.

**HEADSET CALLS** - If a headset is connected to the phone, you need to press the headset key to direct the call to the headset. The headset key will be lit. To use the headset:

- Press the **Speaker** button.
- Place an internal or external call.
- Press **Speaker** button to disconnect the call.

**NOTES:**

1. If you need to switch between the headset and the handset during the call, you need to place the call on hold first.
2. Headset key can be enabled or disabled in the Menu, Settings, Application Setting, Headset.

## ANSWERING CALLS

**OUTSIDE/INTERNAL/VOICE ANNOUNCE CALLS** - To answer these three types of calls:

- Lift the handset or press the **Speaker** button to answer on **Speakerphone**.
- Hang up the handset when the call is completed.

**NOTE:** The volume can be adjusted at any time by pressing the up and down buttons on your navigation button.

## PLACING A CALL ON HOLD

Calls can be placed on **System Hold** or **Exclusive Hold**. A call placed on System Hold can be picked up from any extension. Calls placed on Exclusive Hold can only be picked up from the extension that placed them on hold.

**SYSTEM HOLD** - To place a call on hold:

- Press the **Hold** button. The **Call** button will flash green at your telephone.
- To take the caller off hold, press that button and the red flashing light will go steady red again.
- Resume conversation.

**EXCLUSIVE HOLD** - To place a call on hold at your telephone so that other users cannot answer it:

- Press the **Hold** button twice. The call button will flash green at your telephone.
- To retrieve the call, press the flashing red line button or press the line button a third time.

**NOTE:** Internal calls are always placed on exclusive hold.

## TRANSFERRING CALLS

You can transfer a call by notifying the party to which the call is being transferred or without notification.

- While on a call, press the **Transfer** button then dial an extension number.
- Confirm you hear a ringback tone.
- Wait for the called party to answer and announce the call (optional).
- Replace the handset.

## TRANSFERRING WITH CAMP-ON

When you transfer a call to another station and receive a busy signal, you can camp the call on to this station. Hang up when you hear the busy signal. The called party is alerted that a call is waiting.

- Call another internal station.
- When receiving a busy tone, press the **Func.** soft button.
- Scroll to **Camp On** and press **OK** button (here ringback tone). Wait for party to answer the call.

**NOTE:** If you receive No More Calls tone, that station has no button available to receive another call. Press **Transfer** to return to the caller.

## CALL WAITING

If an outside call is camped-on to your phone or another station is camped-on to you:

- Your keyset rings and the call that is waiting (camped-on) flashes red.
- Press the flashing button to answer; the other call is put on hold automatically if your station has the Automatic Hold feature set. If not, you must press **Hold** and then the flashing button or finish the first call and hang up; the waiting call will ring.
- Lift the handset or press the **Speaker** button to answer.

**NOTE:** Intercom calls will not go on Automatic Hold.

## CONFERENCE CALLS

To make a conference call while engaged in a conversation:

- Press the **Conference** button and receive conference tone.
- Make another call, either intercom or outside, press the **Conference** button and receive conference tone.
- Make another call or press the **Conference** button to join all parties. You can conference up to five parties (you and four others).
- Repeat the last step until all parties are added.
- Hang up to leave the conference call.

**NOTE:** When attempting to add another party to the conference and you are not able to reach the desired person, hang up. Simply press the **Conference** button again to return to the previous conversation.

### To drop a party from your conference call:

- Press the **Conference** button and dial the extension or line number that is to be dropped.
- Press the **Conference** button again to reestablish the conference.

## FORWARDING CALLS Icon

You can forward your calls to another station, group of stations, or an external telephone number. Program a destination for the type of forwarding you want by moving the **Selector Switch** to the **left** and set the **forwarding number for All, Busy, No Answer, and Busy/No Answer**.

## OTHER FEATURES AND FUNCTIONS

**VOLUME CONTROL - Vol** button is used to adjust the volume of a handset, speaker and ringing sound.

### Volume Control of a Handset

- Adjusts the handset volume while busy (handset offhook).
- To increase the volume of a handset, press the top side **[+]** of the **Vol** button.
- To decrease the volume of a handset, press the bottom side **[-]** of the **Vol** button.

### Volume Control of a Speaker

- Adjusts the speaker volume while busy (handsfree).
- To increase the volume of a speaker, press the top side **[+]** of the **Vol** button while ringing.
- To decrease the volume of a handset, press the bottom side **[-]** of the **Vol** button while ringing.

### Volume Control of a Ringing Tone

- To increase the volume of a speaker, press the top side **[+]** of the **Vol** button while ringing.
- To decrease the volume of a handset, press the bottom side **[-]** of the **Vol** button while ringing.

### Volume Control of Key Tone

- To increase the volume of the key tones, press the top side **[+]** of the **Vol** button.
- To decrease the volume of the key tones, press the bottom side **[-]** of the **Vol** button.

**NOTE:** By pressing the **Vol** button in idle mode, the user can also adjust the key tone volume.

**LAST NUMBER REDIAL** - To redial the last dialed telephone number, when in **Function Mode**, scroll to **Last Redial**, then press the **Selection** button in the upper right corner of the phone.

**PHONE BOOK BUTTON** - Provides direct access to personal phonebook (local to the phone) or company phonebook (required administrator set-up).

**MESSAGE BUTTON** - This function allows users to select which desired type of messages is viewed. Users can select and view the following options: **Voicemail Messages, Station Messages, E-Mail** (optional with IP-UMS only), and **Short Message Service (SMS)**. **Short Message Service** is similar to sending text messaging [Function only supported on Samsung IP phones].

**SERVICE BUTTON** - Used to allow station users access to setting and editing the scheduler (alarm clock) feature. Also used to connect the OfficeServ Communicator when application is available (UC is optional).

**MENU SOFT BUTTON** - This menu displays the following options:



**NOTE:** The **Navigation** button can be used to scroll through these options.

- 1. PHONEBOOK:** Maintains frequently dialed names and numbers in a Phonebook. Search and initiate calls by: Speed Dial, Associated Names, Telephone Numbers, Assigned Groups, or Previous Calls registered to your phone.
- 2. CALL LOG:** Provides direct access to a list of most recent calls, outgoing calls, incoming calls, missed calls, and an option to delete/delete all (or clear) all calls from the **Call Log**. Press the Navigation Right or Left button to display only missed calls, incoming calls, or outgoing calls. The type of calls is classified by icon.
- 3. MESSAGES:** This function allows users to select which desired type of messages is viewed. Users can select and view the following options: **Voicemail Messages, Station Messages, E-Mail** (optional with IP-UMS only), and **Short Message Service (SMS)**. Short Message Service is similar to sending text messaging [Function only supported on Samsung IP phones].
- 4. CONFERENCE:** Allows a user to setup a **conference group** to call multiple parties simultaneously to join the conference call.

## BOTTOM ROW SOFT BUTTONS

**HOME:** The **Home icon** button function is used to return the phone to the main default screen from the other display screens.

**SERVICE:** Allows a user to access additional services. These services require set up by the system administrator.

**PHONE:** Allows the user to set many phone options for the phone such as ring tones, background screens, languages, forward, DND, etc.

**SETTINGS:** This function allows the user to set the following option: **Application Set., Call Forward, Absent Message, AOM Setting, Network Info., and Clear User Set.**

**CALL LOG SOFT BUTTON** - Provides direct access to a list of most recent calls, outgoing calls, incoming calls, missed calls, and an option to delete/delete all (or clear) all calls from the **Call Log**. Press the Navigation Right or Left button to display only missed calls, incoming calls, or outgoing calls. The type of calls is classified by icon.



**BACK SOFT BUTTON** - The **Back** soft button (only displayed for Missed calls or Messages) is actually a toggle between the multi-purpose selection buttons in the upper right side of the phone. When the station user has messages or missed calls, the main screen show the **Back** soft button to display the status of all Message types (Missed Calls, Voicemail, Station message, Email, and Short Message). Pressing the Back button will change to Function button and display features. Pressing the Function soft button again will display the 99 button AOM, and pressing the **AOM** soft button will move to the HomeBuddy screen (optional). Pressing the **HomeBuddy** soft button will return to the Function button.

**FUNC. SOFT BUTTON** - This function allows a user one touch easy access to many of the system features. When pressed, the following options are displayed: Last number redial, Save/Repeat, Speed Dial, Directory, VM Message, Station Message, Page Pickup, Direct Pickup, DND, In/Out Group, Status Message, Hold pickup, Page, Meet me Page, OHVA Block, Group Pickup, and My Group Pickup. The **Navigation** button can be used to scroll up and down the list of features under the Func. button.



**NOTE:** **EXE/SECR MSG** is displayed only when the phone is programmed for Boss/Secretary feature.

### Example of using the Last Number Redial feature:

- When in **Function Mode**, scroll to **Last Redial**, then press the **Selection** button. The last number called from the phone is called.

**NOTE:** For detail operation of the list of features under the Func. soft button, please refer to the System Features section of the user guide.

**AOM SOFT BUTTON** - This function is used to display all 99 programmable feature buttons of the phone. The **Navigation** button can be used to scroll up and down the list of 99 programmable feature buttons under the soft AOM.



### Example of dialing a Speed Dial Number using the AOM function:

- Press the **AOM** soft button, scroll to desired **Speed Dial**, then press **Selector** button. The number is called from the phone.

**NOTE:** Some programmed features such as speed dialing and DSS buttons can be used to process calls; other programmed buttons such as Call buttons can only be viewed.



The soft AOM button can also display status indications for station keys, trunks, voice mail messages, etc.

### Example of programming a DSS button on the soft AOM:

- Press the **Menu** soft button.
- Press the **Settings** soft button then scroll to **Application Setting**, and press **OK**.
- Scroll to **AOM Setting** and press **OK**.
- Scroll to soft **AOM** button to program (for example: 4).
- Press the **Edit** soft button (the display will show feature).
- Scroll to the feature option (for example: DSS).
- Move down and enter the extension number (for example: 2003).
- Move down, use the dial pad to enter name (for example: John Dow).
- Press the **Save** soft button to exit and save the setting.

**OK/ENTER BUTTON** - This function is used to enter, save or complete the selected option in the display.

**SPEAKER BUTTON** - This function is used to go on and off hook in the hands-free speakerphone mode.

## LCD POWER SAVING FEATURE

SMT-i5243 LCD display has a power saving feature. The display will be automatically turned off after the pre-defined time. The default time setting is 08:00 to 18:00. Users can change the period to meet their needs.

The display will automatically go dim after some inactivity during this pre-defined time. The default dim time is 30 seconds but users can adjust it. The display will automatically turn on with any user activity or incoming call.

To change the LCD power saving setting, press **Menu, Phone, Screen, LCD Power Saving**.

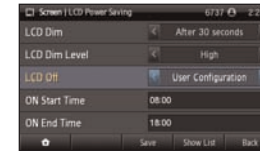

- LCD Dim:** The display will go dim after the defined time. Default time is 30 seconds.
- LCD Dim Level:** The display can go to one of the three dim levels. The default level is High. The display will turn off or go dark after the dim time if the level is set to off.
- LCD Off:** The display will be turned off with the defined time. The default setting is "User Configuration" with "On Start Time: 08:00 and ON End Time: 18:00".

## SECTION 4. PHONE FEATURES

## BASIC MENUS

The basic menus screen is displayed if you select the **Menu** from the soft menu at the left bottom of a idle screen. Using the **Navigation** button, move to a desired function, and press the **OK** button to execute the function.

## SOFT BUTTON STRUCTURE

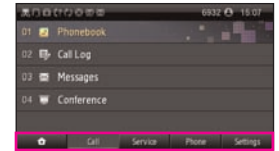

## MENU SOFT BUTTON

Button	Sub-Item	Description
<b>Call</b>	01. Phonebook	Provides the function to save, search and register a phonebook.
	02. Call Log	Shows all information on inbound/outbound calls and missed calls.
	03. Messages	Enables the creation/saving and sending/receiving of a message.
	04. Conference	Supports a conference call.
<b>Service</b>	01. Buddy List	The user can view the buddy list registered by a user, or add the data (optional, requires OfficeServ Messenger).
	02. Buddy Setting	The status of a user who logged into the presence server can be changed (optional, requires OfficeServ Messenger).
	03. Video Contents	The user can view and play the Video Contents of the Video Contents Server (optional).
	04. Scheduler	The user can register and manage his schedule.
	05. XML Browser	The user can search and use the information provided from the XML browser server (for future use).
<b>Phone</b>	Allows the user to set many phone options for the phone such as ring tones, background screens, languages, etc.	
	01. UC Dial: Right	Options are <b>DND</b> and <b>Absent Message</b> .
	02. Screen	Options are <b>Display Time, Font, and LCD Power</b> .
	03. Sound	Options are <b>Volumes, Ring Tone, and Key Tone</b> .

Button	Sub-Item	Description
<b>Phone (Continuation)</b>	04. Language	Multiple languages are available.
	05. Security	Change <b>Password, Dial and Phone Lock.</b>
	06. Phone Information	<b>Easy Install:</b> Used to register and authenticate the phone to the server.
		<b>Phone Information:</b> Includes Version Info, Network Info, and MAC Address.
		<b>Network:</b> Options are Static IP, Dynamic IP, PPPoE, VLAN (LAN Port), VLAN (PC Port), 802.1x.
		<b>Server:</b> Used to register the phone to one or more Servers. Options are Primary, System 1, System 2, System 3.
		<b>Extension Login:</b> Used to log phone on and off (Hot Desking).
		<b>S/W Upgrade:</b> Upgrade Server, Upgrade: used to upgrade software on phones.
<b>Factory Reset:</b> Used to default the phone settings.		
<b>Phone Restart:</b> Used to reboot the phones.		
<b>License:</b> Display the licensing policy.		
<b>Settings</b>	This function is used to allow station users to set <b>application settings, call forwarding, absent messaging, AOM setting, view station network information, view phone firmware or initialize the phone.</b> Other settings include the following:	
	01. Application Setting	Options are <b>Call, Video Call, Short Message, Station on/off, AOM Setting, Extension Login, and Headset.</b>
	02. Call Forward	Options are <b>Not Use, All, Busy, No Answer, Busy/No Answer, DND, and Follow Me Status.</b>
	03. Absent Message	Used to leave <b>station messages</b> in display informing other internal parties of your status when your station is called.
	04. Network Information	Used to view the current <b>network settings.</b>
	05. User Data Management	Options are Clear User Settings, Export Phonebook to USB, Import Phonebook from USB.

## CALL MENUS

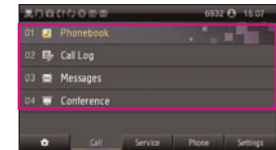

Item	Sub-Item	Description	
<b>01. Phonebook</b>	All	Shows the entire list of phone numbers stored in the phone.	
	<b>Personal Phonebook</b>	Unassigned	This is a list of number that are not assigned any group.
		Home	Returns to the phone main screen.
	Search	Allows a user to search for a registered phone number by name/number.	
	New	Saves a phone number or group name; and allows a user to specify a speed dialing number and ringtone.	
	Edit Group	Allows a user to delete/delete all the phone numbers saved in the phone.	
	Back	Used to move back one menu screen.	
<b>02. Call Log</b>	Home	Returns to the phone main screen.	
	Call	Used to make a callback from the call log.	
	Save	This is used to save entries from call log to phonebook.	
	Edit Mode	This is used to delete entries from the call log.	
	Back	This is used to to move back one menu screen.	
<b>03. Messages</b>	Voice Mail (0)	Allows a user to retrieve voice mail messages from the mailbox.	
	Station Message (0)	Allows a user to retrieve station messages (internal) from another user.	
	Email (0)	Allows a user to to view how many e-mail messages have been received via IP-UMS (optional).	
	Short Message (0)	Allows a user to retrieve and send internal short messages (SMS) like text message to other internal phones. <i>[Not Supported Over Networking]</i>	



Item	Sub-Item	Description
<b>04. Conference</b>		Allows a user to setup (show, add and edit) a <b>conference group</b> to call multiple parties simultaneously to join the conference call.
	Home	Returns to the phone main screen.
	Add Group	Allows a user to create a new conference group with up to 4 members.
	Edit	Allows a user to modify the numbers saved in the group.
	Delete	Allows a user the option to delete an entry in the conference group.
	Back	Used to move back one menu screen.

## 01. PHONEBOOK

Company phonebook requires setup by the System Administrator.

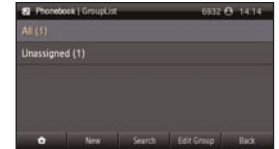

### PERSONAL PHONEBOOK

**NOTE:** Personal phonebook is stored locally in phone memory.

#### All

Shows the entire list of phone numbers saved in the phone book.

- Press the **Phonebook** button—**OR**—press the **Menu** soft button, scroll to **Phonebook**, press **OK**, scroll to **All**, and then press **OK**.
- The entire list of phone numbers saved in the phone book is shown on the screen. Using the **Navigation** button, move to a desired entry, and select the **Call** soft button to place a call.

#### Unassigned Group

The Unassigned option is a list of all the phonebook entries that have not been assigned to a group. Once an entry is assigned to a group, the entry is removed from the unassigned list.

#### TO CREATE A PHONEBOOK GROUP

To create a group in the phonebook:

- Press the **Phonebook** button, then press the **Edit Group** soft button, then press the **Add Group** soft button.
- Using the key pad, input the **name** of the group and **ring tone**, then press the **Save** soft button. [See Text Input Method.](#)
- Press **Save** soft button to exit.

#### TO MOVE UNASSIGNED ENTRY TO PHONEBOOK GROUP

- Press the **Phonebook** button, scroll to **Unassigned** option then press **OK** button.
- Scroll to the entry that is to be moved to an assigned group and press **OK** button.
- Press **Edit Mode** soft button, scroll to and highlight the **desired entry**, press **OK**. Scroll to **Group** option.
- Using the **Navigation** button, move **Left** or **Right** to the group name (eg; Personal) which you want to move the entry into.
- Once the correct entry is displayed, press the **Save** button. The entry is now assigned to the group.

## Search

Allows a user to search by name/number for a phone saved in the phone book.

- Press the **Phonebook** button—OR—press the **Menu** soft button, scroll to **Phonebook**, press **OK**.
- Press the **Search** soft button from the dial pad enter the characters of the name (case sensitive) or number to search and press the **OK** button, the matching phone number is displayed. Move to a desired name/number using the **Navigation** button, and select the **Call** soft button to place a call.

## Add New Entry to Phone Book [+]

This is the function used to register a phone number.



- Press the **Phonebook** button—OR—press the **Menu** soft button, scroll to **Phonebook**, press **OK**.
- Press the **New** soft button, and then **New**.
- Enter a **name** by using the dial pad, scroll down and enter a **mobile number, home number, office number, internal extension number, fax number, and e-mail address**.
- Assign a **Group** (if needed).
- Select a **Ring Tone**.
- Add **Memo** information (up to 50 characters).
- Press the **Save** soft button to save the new entry to the Phone Book.

## DELETE / DELETE ALL

This is the function used to delete all the phone numbers saved in the phone book.

- Press the **Phonebook** button—OR—press the **Menu** soft button, scroll to **Phonebook**, press **OK**.
- Scroll to **All** and press **OK** button. Scroll to entry to delete.
- Press **Edit Mode** soft button. Press **Del.** to delete the selected entry or **Del All**.
- Press the **Yes** to **Delete** entry.

## 02. CALL LOG

-  **Outgoing**
-  **Incoming**
-  **Missed Icons**

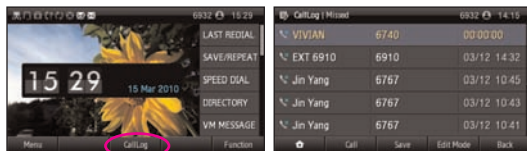

This function lists all the recent numbers for outgoing, incoming and missed calls.

- Press the **Call Log** soft button—OR—press the **Menu** soft button, scroll to **Call Log**, press **OK**. A phone number list of recent outgoing, incoming and missed calls is displayed.
- Scroll to an entry and press the **Call** soft button to dial the number. Press the

Navigation Right or Left button to display only missed calls, incoming calls, or outgoing calls. The type of calls is classified by icon.

## DELETE / DELETE ALL

This is the function used to delete an entry or all entries in the Call Log.

- Press the **Menu** soft button, scroll to **Call Log**, press **OK**.
- Scroll to entry to delete.
- Press **Edit Mode** soft button. Press **Del.** to delete the selected entry or **Del All**.
- Press the **Yes** to **Delete** entry.

## TO ADD A CALL LOG ENTRY TO PHONE BOOK

- Press the **Menu** soft button, scroll to **Call Log**, press **OK**. Scroll to desired **Call Log entry** and press the **Save** soft button then press the **New** soft button. Make changes to the name and number if necessary. When finished, press the **Save** soft button. The Call Log number is added as a new entry to the phone-book list.

## 03. MESSAGES

### 1. Voice Mail

This function allows users to retrieve voice mail message from the mailbox.

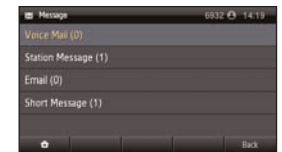

- Press the **Message** button—OR—press **Menu** soft button, scroll to **Messages**, press **OK**, scroll to **Voice Mail [ ]**, and then press **OK** to access the voicemail box and retrieve messages.

### 2. Station Message

This function allows users to retrieve station messages (internal) from another user.

- Press the **Message** button—OR—press the **Menu** soft button, scroll to **Messages**, press **OK**, scroll to **Station Message [ ]**, and then press **OK**.
- To return a call to the station that left the message: press the **Reply** soft button.
- To delete the station message: press the **Clear** soft button.
- To view the next station message: press the **Next** soft button.

### 3. E-Mail

This function allows users to view the amount of e-mails for a station user's account. This function is only available when the IP-UMS application is enabled. Please refer to the IP-UMS manuals for detailed operation.

## 4. Short Message (SMS)

This function is used to send and create internal short messages or text messaging.

### INBOX

- Press the **Message** button—**OR**—press the **Menu** soft button.
- Scroll to **Short Message**, press **OK**.
- Scroll to **Inbox**, then press **OK** to view a short text message(s) in you Inbox.
- Press the **Edit Mode** soft button, then the **Delete/Delete All** soft button, and the **Yes** soft button to delete the selected short text message or press the **Back** soft button to exit Short Message.

### NEW MESSAGE (SEND)

This function is used to create and send a new short text message.

- Press the **Message** button—**OR**—press the **Menu** soft button.
- Scroll to **Short Message**, press **OK**.
- Press **New** soft button. Write or create a new short message and press the **Number Set** soft button. [See Text Input Method on how to enter characters in text messages.](#)
- Enter the internal extension(s) to send the short message. Scroll to other entries and enter the station number to send to more users. (Each short message can be sent to 1 through 10 users).
- Press the **Send** soft button to deliver the short message to other user's inbox.

### NOTES:

1. When the message is sent successfully, the message "Completed" is displayed. When the message fails to send the "Failed to send" is displayed.
2. SMS messages can only be sent to internally ITP, SMT-W, or SMT-i phones. TDM and single line phones cannot send or receive SMS messages. SMS messaging is not supported over networking.

### OUTBOX

This function is used to create and send a new short text message.

- Press the **Message** button—**OR**—press the **Menu** soft button.
- Scroll to **Short Message**, press **OK**.
- Scroll to **Outbox**, then press **OK** to view short text message sent from your phone.
- Press the **Edit Mode** soft button, then **Del/Del All** soft button to delete the short text message(s) or press the **Back** soft button to exit SMS.

## 04. CONFERENCE [Group]

This function allows a user to setup a conference group to call multiple parties simultaneously to join the conference call.

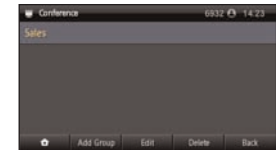

### CREATING CONFERENCE GROUP

- Press the **Menu** soft button, scroll to **Conference**, and press **OK**.
- Press **Add Group** soft button, enter the name and phone number (up to 4 numbers) of the parties included in the Conference Group.
- Press the **Save** soft button.

### TO CREATE AN UNSUPERVISED CONFERENCE

- During the conference, the host can press the **Host** soft button.
- The host is dropped and the other parties remain in conference.

### TO DISCONNECT A PARTY FROM CONFERENCE GROUP

- Highlight the party to be disconnected from the conference group.
- Press the **Disc.** soft button. The party is disconnected.
- Press the **Reconnect** soft button to call back and add the party back to the conference group.

### TO EDIT A CONFERENCE GROUP

- Press the **Menu** soft button, scroll to **Conference** button, and press **OK**.
- Scroll to the **Name of the Group** to be edited and press **Edit** soft button.
- Edit the group name. When complete, press the **Save** soft button to save changes.

### TO EDIT CONFERENCE GROUP PHONE NUMBER LIST

- Press the **Menu** soft button, scroll to **Conference** button, and press **OK**.
- Scroll to the **Name of the Group** to be edited and press **Edit** soft button.
- Edit the name and phone number list—**OR**—  
Press **Search** soft button to search for phone number to add to group from the phonebook. Highlight the entry and press the **OK** button to add the number to the Conference Group list.
- When complete with the editing, press the **Save** soft button to save changes.

## SERVICE SOFT BUTTON

Allows a user to set the alarm clock function.

- Press the **Service** button—**OR**—press the **Menu** soft button, scroll to **Scheduler**, then press **OK**.
- Press the **New** soft button.
- Enter the **Title, Place** of the scheduler using the dial pad and navigation buttons.
- Enter the **Date, Time, Alarm Type**, and **Ring Tone**. Press **Save** soft button when finished.



### TO DELETE A SCHEDULE

- Press **Menu** soft button. Scroll to **Service** button, and press the **OK** button.
- Select **Scheduler** and press the **OK** button.
- To delete a current schedule, press the **All List** soft button.
- Select and highlight the entry to be deleted and press **Delete** soft button—**OR**—press the **Delete All** soft button to clear all schedules.
- Select **Yes** to confirm or **No** to deny the deletion of a schedule(s).
- Press **Back** soft buttons twice to exit the scheduler.

## PHONE SOFT BUTTON

Allows the user to set many phone options for phone such as ring tones, background screens, languages, etc.

### 01. UC Dial: Right

This option is used to select which function will be enabled when the selector switch is moved to the right position.

- Press the **Menu** soft button. Scroll to **Phone**.
- Scroll to **UC Dial: Right** and press **OK**.
- Select **DND** or **Absent Message** and press **Save** soft button.

### 02. Screen

- Press the **Menu** soft button. Scroll to **Phone** and press **OK**. Select **Screen** and press **OK**. Set the following **Idle Screen Decoration, Brightness, LCD Power Saving**, and **Screen Saver** of the SMT-i5243 phone, select the option and adjust the screen settings.
- Press the **Save** soft button to store the screen settings.



### 03. Sound

- Press the **Menu** soft button. Scroll to **Phone**. Select **Sound** and press **OK**. Set the following **Volumes, Ring Tone, Key Tone**, and Short Message Tone of the SMT-i5243 phone, select the option and adjust the sound settings.
- Press the **Save** soft button to save the sound settings.

### 04. Language

- Press the **Menu** soft button. Scroll to **Phone**. Select **Language** and press **OK**. Select English (Default English).
- Press the **Save** soft button.

### 05. Security

- Press the **Menu** soft button. Scroll to **Phone**. Scroll to **Security** and press **OK**.
- Enter the station password [default 1234].
- Press **OK** soft button to **Change Password**.
- Scroll to **Call Lock** to **Unlock, Lock Out** (Outgoing), or **Lock All**.
- Scroll to **Phone Lock** to **Unlock** or **Lock** the Menu.
- Press the **Save** soft button.

### 06. Phone Information

Allows a user to set up the following options: **Easy Install Wizard** (registering the phone), **Phone Information** (Version, Network, MAC Address), **Network** (Static, Dynamic, etc.), **Server** (Phone can register to 1 to 4 servers), **Video Option, Extension Login** (logging in and out IP phones), **Software Upgrade** (Upgrading the phone or server software), **Factory Reset** (defaulting the phone), and **Phone Restart** (rebooting the phone).

**NOTE:** The license policy can be viewed by pressing the **License** soft button.

## SETTING SOFT BUTTON

This function is used to allow station users to set **Application Settings, Call Forward, Absent Message, Network Information**, and **User Data Management**.

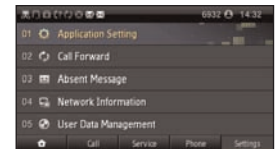

## FUNC. SOFT BUTTON

This function allows a user one touch easy access to many of the system features. When pressed, the following options are displayed: **Last Number Redial**, **Save/Repeat**, **Speed Dial**, **Directory**, **VM Message**, **Station Message**, **Page Pickup**, **Directory Pickup**, **DND**, **In/Out Group**, **Status Message**, **Hold Pickup**, **Page**, **Meet Me Page**, **OHVA Block**, **Group Pickup**, and **My Group Pickup**. The Navigation button can be used to scroll up and down the list of features under the **Func.** button.



**NOTE:** [For detailed operation of the list of features under the Func. soft button, please refer to the System Features section of this user guide.](#)

## AOM SOFT BUTTON

This function is used to display all 99 programmable feature buttons of the phone. The **Navigation** button can be used to scroll up and down the list of 99 programmable feature buttons under the AOM module. The feature buttons can be programmed by a technician.



# SECTION 5. OFFICESERV™ 7000 SYSTEM FEATURES

# OUTSIDE CALLS

## MAKING CALLS FROM AOM

**Note:** When making calls, internal or outside calls, in order to access the **Selector** button screens, press the **Right** soft button to toggle to AOM mode. Then you can utilize the **Navigation** button to scroll the list.

- When the desired number is highlighted, press the associated **Selector** button.
- The number will be automatically dialed.

## UNIVERSAL ANSWER

Outside lines may be programmed to ring a general alerting device. To answer calls ringing this device, dial **67**—**OR**—press the **UA** button. This device can operate in any one of the six different ring plans.

**NOTE:** If the Hot Keypad feature has been turned off, you must first lift the handset or press the **Call** soft button before dialing.

## RECALL DIAL TONE

- Press the **New** button to disconnect your existing call, wait for dial tone and then make a new call on the same line.

**NOTE:** If this button does not appear on your keyset, the **Flash** button may be programmed to recall dial tone.

## SENDING A FLASH

While on an outside call, press the **Flash** button to send a flash to the telephone company. This is required for some custom calling features or CENTREX use.

**NOTE:** Flash is not available on an ISDN circuit.

## BUSY LINE QUEUING WITH CALLBACK

If you receive a busy signal when you are selecting an outside line, this means that the line or group of lines is busy.

- Press the **Callback** button, if programmed, or dial **44**, you will hear confirmation tone.
- Hang up or press **Speaker** button.
- When the line becomes free, the system will call you back.
- Lift the handset or press the **Speaker** button to answer, wait for dial tone and dial the telephone number or speed dial number again.

**NOTES:**

1. A callback will be canceled if not answered within 30 seconds. If you have set a callback, the cursor associated with the **Callback** button will be solid black.
2. If the Hot Keypad feature has been turned off, you must first lift the handset or press the **Speaker** button before dialing.

## BUSY STATION CALLBACK

When you call another station and receive a busy signal:

- Press the **Callback** button, if programmed, or dial **44**.
- When the busy station becomes free, your keyset will ring.
- Lift the handset or press the **Call** soft button to call the now idle station.

**NOTES:**

1. A callback will be canceled if not answered within 30 seconds. If you have set a callback, the cursor associated with the **Callback** button, will be solid black.
2. If the Hot Keypad feature has been turned off, you must first lift the handset or press the **Speaker** button before dialing.

## CANCELING CALLBACK

A callback will be canceled if not answered within 30 seconds. If you have set a callback, the cursor associated with the **Callback** button, will be solid black.

To cancel a callback:

- Press the **Callback** button, if programmed, or dial **44**. The display will show the callback details, press the **Clear** soft button.
- This will cancel the last set callback and display the next set callback. This process is repeated until all callbacks are cleared from memory.

**NOTE:** If the Hot Keypad feature is turned off, you must first lift the handset or press the **Call** soft button before dialing.

## BUSY STATION CAMP-ON

When you call another station and receive a busy signal but you do not want to wait for a callback:

### MANUAL CAMP-ON

- Press the **Camp-On** soft button or dial **45**.
- The called station will receive off-hook ring tone repeated every few seconds and the cursor associated with the first available Call button will flash black to indicate your call is waiting.
- Wait for the called party to answer.
- The called station must release its first call or place it on hold before answering your camp-on.

#### NOTES:

1. If you receive No More Calls tone, that station has no available button to accept your call. Hang up or leave a message.
2. If the Hot Keypad feature has been turned off, you must first lift the handset or press the **Call** soft button before dialing.

#### AUTO CAMP-ON

When you want to automatically camp on to a busy station without pressing the camp on button every time you call a busy station, you can set your phone for auto camp-on.

- With the handset on-hook, press **Transfer** and then dial **110**.
- Dial **081** to turn **On** auto camp-on or dial **080** to turn it **Off**.
- Press **Transfer** to store your selection.

## INTERCOM CALLS

### VOICE ANNOUNCE MODE

When another station calls you, your keyset will sound a brief attention tone and you will hear the caller's announcement.

- Press the **Speaker** button to turn on the microphone and speak handsfree—**OR**—lift the handset to reply.
- To finish the call, replace the handset or press the **Speaker** button.

NOTE: In order for C.O. calls to be answered handsfree, AUTO ANS CO must be set to ON.

### AUTO ANSWER MODE

When another station calls you, your keyset will sound a brief attention tone and then automatically answer the call.

- Your microphone and speaker are turned on and you can speak handsfree. For privacy, use the handset.
- To finish the call, replace the handset.

NOTE: In order for C.O. calls to be answered handsfree, AUTO ANS CO must be set to ON.

### CALLING YOUR SYSTEM OPERATOR

- Dial **0** to call your system operator or group of operators.
- If you want to call a specific operator, dial that person's extension number.

NOTE: If the Hot keypad feature has been turned off, you must first lift the handset or press the **Call** soft button or dial **0** before you begin dialing.

# CALL PROCESSING

## SYSTEM HOLD

When you are connected to any call, press **Hold**. The call will flash at the keyset. If this call appears on a line button at other keysets, it will flash at those keysets also.

- To take the caller off hold, press that button and the flashing LED will go steady again. Resume the conversation—**OR**—press the **Hold** button. The flashing LED will go steady again and you will be connected to the call again. Resume the conversation.

NOTE: While on a call, pressing a line button, route button or flashing **Call** button will automatically put your first call on hold and connect you to the new call. [See Automatic Hold under Customizing Your Keypad.](#)

## EXCLUSIVE HOLD

To place an outside call on hold at your phone so that other users cannot get it:

- Press the **Hold** button twice. The call will flash on your keyset and this line will show a steady indication on other keysets.
- To retrieve the call, press the flashing line button or press the **Hold** button a third time.

NOTE: Intercom calls will always be placed on exclusive hold.

## REMOTE HOLD

When you wish to place an outside call on hold at another station.

- Press **Transfer** and dial the station number (or press the appropriate **DSS** button)
- Press the **Hold** button. This will place the call on system hold on an available **Call** button or Line button at the remote station and return you to dial tone.

NOTES:

1. If the destination station does not have any free **Call** buttons or line buttons you will hear No More Calls tone and must return to the other party by pressing the **Transfer** button.
2. Intercom calls cannot be put on remote hold.

## HOLD RECALL

If you leave a call on hold longer than the hold timer, it will recall your station. The button that the call appears on will have a slow flashing indicator.

- When your phone rings, lift the handset or press the **Speaker** button to answer the recall.
- If you do not answer this recall within a pre-programmed period of time, it will go to the system operator.

NOTE: The Led will flash amber during hold recall.

## CONSULTATION HOLD

When you are talking on an outside line and it is necessary to consult with another extension:

- Press the **Transfer** button; you will receive transfer dial tone. Your call is placed on transfer hold.
- Dial the extension number.
- Consult with the internal party.
- Press **Transfer** to return to the outside party or hang up to transfer the call.

NOTE: Repeatedly pressing the **Transfer** button will toggle between the outside party and internal extension. If necessary you may disconnect either one of the parties by pressing the **Cancel** soft button.

## RETRIEVING CALLS HELD AT ANOTHER STATION [HOLD PICKUP]

When a line is on hold and it appears on your keyset, press the **Line** button with the flashing indicator.

When a line is on hold and it does not appear on your keyset, dial **12** plus the line number or the extension number of the station that placed the call on hold.

NOTE: If the Hot Keypad feature has been turned off, you must first lift the handset or press the **Call** soft button before you begin dialing.



## CALL TRANSFER

Transfer is used to send any calls to another extension in one of two ways. You can do a screened transfer by informing the other extension who is calling or you can do a blind transfer without notification.

- While on a call, press the **Transfer** button and dial an extension number or group number. Your call is automatically put on transfer hold—**OR**—press a **DSS** button or station group button. Your call is automatically put on transfer hold.
- Hang up when you hear ringing (this is an unscreened or blind transfer)—**OR**—wait for the called party to answer and advise him/her of the call and hang up. If the transfer is refused, you will be reconnected to the outside line when the called station hangs up or you can press **Transfer** to return to the outside party.
- If you wish to send the call to another extension without waiting for the first station to hang up, simply press another **DSS** button—**OR**—press the **Call** button or C.O. line button to return to the outside party and begin the transfer process again.
- When you are transferring a call to a keyset set for Voice Announce or Auto Answer, the transferred call will always ring.

### NOTES:

1. After the inside party answers, you may alternate back and forth between the parties by pressing the **Transfer** button.
2. If you receive No More Calls tone, that station has no button available to receive another call. Press **Transfer** to return to the other party.
3. You cannot transfer an Intercom call by pressing a **DSS** button. You must press the **Transfer** button and dial the destination extension number.

## TRANSFER WITH CAMP-ON

When you are transferring a call to another station and you receive a busy signal, you may camp the call on to this station. Simply hang up when you hear the busy signal. The called party will be alerted that a call is waiting for them.

NOTE: If you receive No More Calls tone, that station has no button available to receive another call. Press **Transfer** to return to the outside caller.

## TRANSFER TO VOICE MAIL

This feature is used to send a call directly to a voice mailbox. Your keyset must have a correctly programmed **VT** button to accomplish this. To transfer a call directly to a voice mailbox:

- While on a call, press the **VT** button and dial the mailbox number.
- Hang up when dialing is completed.

## CALL WAITING

If an outside call has been camped-on to your phone or another station has camped-on to you:

- You will hear a tone in the earpiece and the call that is waiting for you (camped-on) will flash. In addition the bottom line of the display will indicate the number of the station or trunk party camped-on.
- Press the flashing button to answer; your other call will go on hold automatically if your station has the Automatic Hold feature set. If not, you must press **Hold** and then the flashing button—**OR**—finish the first call and hang up; the waiting call will ring.
- Lift the handset or press the **Speaker** button to answer.

NOTE: Intercom calls will not go on Automatic Hold. When using the speakerphone the camp-on tone will come through the speaker.

## CALL FORWARD OPTIONS

A display keyset may review or change call forward options and destinations. Call forward access can be done via the keypad or by accessing the keyset display features. To review or change call forward options:

- Press the **Menu** button, press the **Settings** soft button, scroll to the **Call Forward** entry and press **OK**.
- Scroll to the desired **Forward Option**.
- Enter the **Forward Destination**, and press the **Save** soft button.  
—**OR**—
- Press **Transfer 102**.
- Dial **0-5** to select the forward type (e.g., 1)—**OR**—  
Press the **Volume Up** [+] or **Volume Down** [-] to select the forward type  
Press the **Right** soft key to move the cursor.
- Dial the destination number (e.g., **202**)—**OR**—  
Press the **Volume Up** [+] or **Volume Down** [-] to select the destination and  
press the **Right** soft key to move the cursor.
- Dial **1** to set—**OR**—press the **Volume Up** [+] or **Volume Down** [-] to select  
**Yes** or **No** and press **Transfer** to store and exit.  
—**OR**—

### To Forward ALL Calls to Another Station

- Dial **601** plus the extension or group number.
- Receive a confirmation tone and hang up.

### To Forward Calls to Another Station when you are on the Phone (BUSY):

- Dial **602** plus the extension or group number.
- Receive a confirmation tone and hang up.

### To Forward Calls to Another Station when you DO NOT ANSWER:

- Dial **603** plus the extension or group number.
- Receive a confirmation tone and hang up.

### When you have both Forward ON BUSY and Forward NO ANSWER Destination Programmed:

- You can activate them simultaneously.
- Dial **604**. Receive a confirmation tone and hang up.

### To Forward Calls when DND is Activated:

- Dial **605** plus the extension or group number.
- Receive a confirmation tone and hang up.

### To Forward Calls to the Station Where You Currently Are (FORWARD FOLLOW ME):

- Dial **606** plus the extension or group number.
- Receive a confirmation tone and hang up.

To clear all call forward conditions set at your station lift the handset and dial **600**.

## STATION CALL PICKUP

To pick up (answer) a call ringing at another station, lift the handset and dial **65** plus the extension number of the ringing phone. If you have a DP key assigned with a station number, you only need to press this **DP** (Direct Pickup) key with the flashing light to answer this ringing station.

NOTE: If the Hot Keypad feature has been turned off, you must first lift the handset or press the **Call** soft button before you begin dialing.

## GROUP CALL PICKUP

To pick up (answer) a call ringing in any pickup group, lift the handset and dial **66** plus the desired group number (**01-10** on the **OfficeServ 7030, 01-20** on the **OfficeServ 7200-S, 01-99**, and **01-99** on the **OfficeServ 7000 Series**) or press the flashing **GROUP PICKUP** button if available.

### NOTES:

1. A **group pickup** button can have an extender for a specific pickup group.
2. If the Hot Keypad feature has been turned off, you must first lift the handset or press the **Call** soft button before dialing the access code.

## MY GROUP PICKUP

If desired, a new access code can be assigned to pickup ringing calls in the same pickup group as you are in. Like "66" above except you do not need to dial the desired group number. See your installation company for the assigned access code. MY GROUP PICKUP: \_\_\_\_\_.

## PRIVACY RELEASE

This feature will allow another station to join in our conversation by releasing privacy on the C.O. from your phone.

**To Release Privacy:** While you are talking on a C.O. line and you wish to have other internal parties (or up to three) join the conversation.

- Press the **PRB** button (the **PRB** indicator will be steady). Inform the other party that he/she may now join the conversation.

After the other party (or parties) has joined the conversation and you wish to return privacy to the line so that no one else can join the conversation, press the **PRB** button a second time, the **PRB** button LED will be off.

**To Join a Non-Private Conversation:** When someone has informed you that you can join a conversation:

- Press the **C.O. line** button that he/she has indicated OR
- Dial the **C.O. line number** that he/she has indicated.

# DIALING FEATURES

All “DIALING FEATURES” instructions are written to support Overlap Dialing mode. This is the technical name for dialing from a telephone as it has been for many years. In recent years the cell phone industry has changed the cell phones to use Enblock Dialing. With this dialing mode all the digits are dialed and then sent to the carrier after pressing the CALL key. Please check your telephone setup to confirm what dialing mode is used.

## SPEED DIALING

You can dial a preprogrammed telephone number stored in the system-wide speed dial list of numbers 500–999 or from your personal list of numbers 00–49.

Your system may be set for 950 system wide numbers. If so the system speed dial access codes are 050~999 and the station speed dial codes are 000~049.

- From the idle screen with the handset on-hook, press the **AOM** soft button, or dial **16**, scroll to the **Speed Dial** button, press the **OK** button.
- Dial the desired speed dial bin number.
- The telephone number is automatically dialed for you.

NOTE: If the Hot Keypad feature has been turned off, you must first lift the handset or press the **Call** soft button before you begin dialing.

## PROGRAMMING PERSONAL SPEED DIAL NUMBERS

You can program frequently dialed telephone numbers in a personal speed dial list. A station may be assigned up to fifty numbers, **00–49**. See your system administrator to determine the amount assigned to your station. The phone itself maintains 1000 station speed dial numbers.

- While on-hook, press **Transfer** and then dial **105**.
- Dial a speed dial number (**00–49**).
- Dial a line or line group access code.
- Dial the telephone number to be stored (24 digits maximum). It can include **#**, **\***, **FLASH**, **CONVERSION**, and **PAUSE**.
- Press **Transfer** to store the number.

NOTE: If the Hot Keypad feature has been turned off, you must first lift the handset or press the **Call** soft key before you begin dialing.

For the purposes of programming speed dial numbers, the programmable buttons are known as **A**, **B**, **C**, **D**, **E**, and **F**.

- The **A** button is not used.
- The **B** button inserts a flash.
- The **C** button inserts a pause.
- The **D** button is used for pulse to tone conversion. If your system uses rotary (or pulse) dialing C.O. lines, pressing **D** while entering a speed dial number causes all subsequent digits to be sent as DTMF tones.
- The **E** button is used to hide digits. Display keyset users may want to hide some speed dial numbers so that they will not show in the display. When you are entering a telephone number, press **E**. All subsequent digits will be hidden. Press **E** again to begin displaying digits.
- The **F** button is used to enter a speed dial name or number. [See Personal Speed Dial Names under Display Features.](#)
- Use the **Hold** button to clear a speed dial number.



## DIRECTORY DIALING

- Press the **Func.** soft button, scroll to **Directory**, press **OK**.
- Press **Func.** soft button, scroll to the desired **directory**, press **OK**.  
**STATION DIRECTORY** - Accesses Station name directory.  
**PERSONAL DIRECTORY** - Accesses your personal speed dial name list.  
**SYSTEM DIRECTORY** - Accesses System speed dial name list.
- Enter the first letter of the desired party.
- Press the **+/-** buttons to scroll to the desired entry.
- Press the **Func.** soft button.
- Select the appropriate operation, press **OK**.  
**DIAL** - Dials the displayed number.  
**EXIT** - Exit programming and return to idle screen.  
**PREVIOUS** - Moves you to the previous entry.  
**NEXT** - Moves you to the next entry.
- Press **Back** to return to idle screen.

## LAST NUMBER REDIAL

To redial the last outgoing telephone number you dialed, press the **Func.** soft button, scroll to **Last Redial**, or dial **19**.

### NOTES:

1. If the Hot Keypad feature has been turned off, you must first lift the handset or press the **Call** soft button before you begin dialing.
2. Redial does not apply to intercom calls.

## SAVE NUMBER WITH REDIAL

To save the number you just dialed for later use, press the **Save/Repeat** button before hanging up.

To redial this saved number at any time, press the **Save/Repeat**, press **OK** button or dial **17**. The same line will be selected for you.

### NOTES:

1. If the Hot Keypad feature has been turned off, you must first lift the handset or press the **Call** soft button before you begin dialing.
2. The saved telephone number is stored in memory until you save another number.
3. Redial does not apply to intercom calls.

## AUTOMATIC REDIAL/RETRY

When you are making an outside call and you receive a busy signal, the system can automatically redial the number for you. It will automatically redial at a pre-programmed interval for up to 15 attempts.

- When you hear a busy signal, press the **Retry** button.
- The system will reserve the line and automatically redial the same number for you. You will hear the call being made through the keyset speaker. The microphone is muted.
- When the called party answers, lift the handset or press the flashing **Speaker** to begin speaking.

### NOTES:

1. If you make another call, auto-redial is canceled.
2. To cancel an auto-retry, lift and replace the handset.

## PULSE TO TONE CHANGEOVER

When making an outside call on a dial pulse line, press **#**. All digits dialed after the **#** will be sent as tones.

# PAGING AND MESSAGING

## MAKING AN INTERNAL PAGE

To make an announcement through the keyset speakers in the idle condition:

- Lift the handset.
- Scroll to **Page** button or dial **55**.
- Dial the desired zone number **0, 1, 2, 3** or **4**.
- After the attention tone, make your announcement.

### NOTES:

1. If you have a dedicated page zone button, it is not necessary to press **Page** and dial a zone number.
2. If allowed by your system administrator you may be able to initiate a page from a speakerphone by pressing the **Page** key or dialing **55** without lifting the handset.

## MAKING AN EXTERNAL PAGE

To make an announcement through the external paging speakers:

- Lift the handset.
- Scroll to **Page** button or dial **55**.
- Dial the desired zone number **5, 6, 7** or **8**—OR—dial **9** to page all external zones.
- After the attention tone, make your announcement.

### NOTES:

1. If you have a dedicated page zone button, it is not necessary to press **Page** and dial a zone number.
2. If allowed by your system administrator you may be able to initiate a page from a speakerphone by pressing the **Page** key or dialing **55** without lifting the handset.

## ALL PAGE

To page all designated keysets in internal zone 0 and all external zones at the same time:

- Lift the handset.
- Scroll to **Page** button or dial **55**.
- Dial **\*** or press the **All Page** button.
- After the attention tone, make your announcement.

#### NOTES:

1. The LED on the **Page** button will only light when an All Page is in progress.
2. If allowed by your system administrator you may be able to initiate a page from a speakerphone by pressing the **Page** key or dialing **55** without lifting the handset.

## MEET ME PAGE

- Lift the handset.
- Press the Meet Me Page (**MMPG**) button or dial **54**.
- Dial the desired zone number.
- After the attention tone, instruct the paged person to dial **56**.
- Press **Answer Wait** button.
- Remain off-hook until the person dials **56** from any phone.
- The paged person will be automatically connected with you.

## CALL PARK AND PAGE

When you have an outside call for someone who is not at his/her desk, you can park the call prior to paging. The OfficeServ 100, OfficeServ 500, and OfficeServ 7000 Series systems offer two different methods:

#### MANUAL PARK ORBITS

- While in conversation, press the **Park** button.
- Entered a desired orbit number (**0-9**), if the orbit number is busy dial another orbit number. Display users can press **\*** to automatically place the call in any available orbit number and see the number in the display.
- Remember the selected orbit number.
- Replace the handset when finished.
- Lift the handset and make a page announcement as previously described (example: "John Smith park two").

#### To retrieve a parked call from orbit:

- Press the **Park** button and dial the announced orbit number (**0-9**).
- You will be connected to the parked call.

#### NOTES:

1. You must have a **Park** button or park access code to retrieve and place calls in park orbits.
2. If the parked call is not retrieved within a pre-programmed period of time, it will recall your keyset and have a slow flashing amber light. You cannot park and page intercom calls.
3. If the Hot Keypad feature has been turned off, you must first lift the handset or press the **Call** soft button before you begin dialing.

#### AUTOMATIC PARK WITH PAGE BUTTON

- While in conversation, press the **Page** button. The call is automatically parked at your station.
- Receive page tone and dial a desired page zone number.
- Make announcement indicating your extension number or the line number. Hang up.

#### To retrieve an automatically parked call:

- Dial **10** plus the number that was announced. If you have a **PAGPK** button, press it and dial the number that was announced. If you have a **Park** button, press it and dial the announced orbit number.
- You will be connected to the parked call.

#### NOTES:

1. If the call is not retrieved within a pre-programmed period of time, it will recall your keyset and have a slow flashing amber light. You cannot park and page intercom calls.
2. If the Hot Keypad feature has been turned off, you must first lift the handset or press the **Call** soft button before you begin dialing.

## SETTING A MESSAGE INDICATION

When you are calling another station and no one answers or you receive a busy signal, you can leave a message indication:

- Scroll to **Message** or dial **43** and receive confirmation tone. Hang up.
- The message button on the Main Programmable Button screen and the TSI will flash red at the called station.

#### NOTES:

1. A station can have up to five message indications.
2. If the Hot Keypad feature has been turned off, you must first lift the handset or press the **Call** soft button before you begin dialing.

## CANCELING MESSAGES

To cancel a message indication that you left at another station, dial **42** plus the extension number of the station at which you left a message.

- To cancel all message indications left at your keyset, dial **42** plus your extension. Your **Message** button indicator will stop flashing and the TSI will go out.

NOTE: If the Hot Keypad feature has been turned off, you must first lift the handset or press the **Call** soft button before you begin dialing.

—OR—

- Press **Message** button, scroll to **Station Messages**, press **OK**.
- Press **Clear**.

## RETURNING MESSAGES

- Press **Message** button, scroll to **Station Message**, press **OK**, press **REPLY** or dial **43**. The first station that left a message will be called automatically. If that station does not answer, the called station **Message** button indicator will continue to flash and the TSI will stay on.
- Repeat until all messages have been returned in the order received.
- Your **Message** button indicator will stop flashing and the TSI will turn off when all messages have been returned.

NOTES:

1. Display keyset users can view message indications and return them in any order. [See Viewing Message Indications under Display Features.](#)
2. If the Hot Keypad feature has been turned off, you must first lift the handset or press the **Call** soft button before you begin dialing.
3. If a message has been left at your keyset by a keyset in Auto Answer, you must manually cancel the message after it has been returned.

## PROGRAMMED MESSAGES

When you will be away from your phone for any length of time, you can leave a programmed station message. Display stations calling you will see this message and be informed of your status or follow your instructions.

- Dial **48** plus any of the message codes (**01–20**) listed on the back of this user guide.
- To cancel any of these messages you might have selected, dial **48** plus **00**.
- Press **Transfer** to exit and store your selection.

NOTE: If the Hot Keypad feature has been turned off, you must first lift the handset or press the **Call** soft button.

You can have multiple programmed message buttons (**PMSG**) and each one can have a different message code:

- Press any programmed message (**PMSG**) button. The message is set and the PGM MSG button indicator will be lit steady. Press the button again to turn off the programmed message and the indicator will go blank.
- Pressing another programmed message (**PMSG**) button will turn the previous one off and set a different programmed message.

# CONVENIENCE FEATURES

## LOGGING IN AND OUT

If enabled, your SMT-i5243 telephone may require you to log in before making or receiving calls. In these cases your telephone system administrator will provide you with an extension number, password, and the feature code used to log out.

**To log in:**

- At **Extension Login Screen** enter your ID which is your extension number.
- Scroll down to the **password** field and enter your **station password**.
- Press on **Save** soft button or **OK** button.

**To log out:**

- Dial the feature code provided by your administrator (for example 77).

## DO NOT DISTURB

Use this feature when you want to block calls to your keyset.

- While on-hook, press the **DND** button or dial **401**. The **DND** button indicator will be lit steady to remind you of this mode.
- To cancel **DND**, press the **DND** button again or dial **400**. The **DND** button indicator goes blank. You can make calls while in the DND mode.

NOTES:

1. If the Hot Keypad feature has been turned off, you must first lift the handset or press the **Call** soft button.
2. If you place your keyset in **DND** mode and you do not have a **DND** button, your **Telephone Status Indicator** button will fast flash red to indicate DND status.
3. The **selector switch** can also be used to set/cancel DND.

## ONE TIME DND

If you are on a call and you do not wish to be interrupted while on that call, you can press the **DND** button and place your station in Do Not Disturb. When you hang up at the end of the call, DND will be automatically canceled and your keyset will be able to receive new calls. This feature requires a **DND** button.

## MUTE

You can mute the handset transmitter or the microphone during any conversation:

- Press the **Mute** button. The **Mute** button indicator will be lit steady.
- To resume speaking, press the **Mute** button again. The **Mute** button indicator goes blank.

## BACKGROUND MUSIC

When a music source is supplied, you may listen to music through the speaker in your keyset:

- While on-hook, press the **Hold** button to hear music.
- Press the **Hold** button again to turn music off.

You can set the level of background music by using the **Volume** buttons while listening to the music. This does not affect the speakerphone level.

## ESTABLISHED CALL PICKUP

To pick up an established call in progress at a single line extension connected to a computer modem on your PC.

- Press the **EP** button for that station on your keyset and the call is automatically moved to your keyset.
- The single line extension on your modem will be disconnected.

NOTE: You must have an assigned (**EP** button) button on your regular keyset, for the single line station.

## ANSWERING THE DOOR PHONE

When you are programmed to receive calls from a door phone:

- You will receive three short rings repeated.
- Lift the handset. You are connected to the door phone.
- If an electric door lock release is installed, dial **13** to unlock the door.

## CALLING THE DOOR PHONE/ ROOM MONITOR

You may call the door phone and listen to what may be happening outside or in another room.

- Dial the extension number of the door phone.
- You will be connected to the door phone and you can listen or have a conversation.
- If an electric door lock release is installed, dial **13** to unlock the door.

NOTE: If the Hot Keypad feature has been turned off, you must first lift the handset or press the **Call** soft button.

## EXECUTIVE/SECRETARY [HOT LINE]

If programmed, an executive boss and a secretary can have a hot line between them. When the executive station is in the DND mode, all of its calls will ring the secretary station. If the secretary does not answer, the caller will go to the secretary's voice mail box if setup.

When an Executive/Secretary hotline is programmed to this keyset, the keyset offers an additional screen option. This screen has options for setting the status of the keyset user. This status update is viewable to EasySet users only.

- Either person can press the **Boss** button to make a voice call to the other station.
- Using the hot line will override DND at the other station. This button will have a flashing indication when the other station is in use.

### To transfer a call to a Boss in DND:

- Press the **Boss** button.
- Wait for the **Boss** to answer, then announce the call and hang up to complete the transfer—**OR**—hang up to complete a blind transfer.

### Executive/Secretary (Messaging):

When the Boss or Secretary is needing to inform the other party of their current status, they can send a message to their display. Both the Boss and Secretary phone must be SMT-i5200 Series model phones for Executive/Secretary Messaging to work.

- Scroll to **EXE/SECR MSG**, scroll to **Messages**, and press **Select** soft button.
- Select and highlight one of the **Return On** messages and press the **Edit** soft button.
- Press and hold the **Delete** soft button to erase the default message.
- Using the dial pad, type in the new message ([refer to Text Input Method](#)).

- When finished press the **OK** soft button then the **Send** soft button to display the message on the other (Boss/Secretary) phone.

## GROUP LISTENING

When you are engaged on a call and you are using the handset, you may want other people to hear the distant party's voice over the speaker:

- Press the **Group Listen** button to turn on the speaker. The microphone is not in use, so the distant party does not hear other parties present in your office.
- Press **Group Listen** again to turn the speaker off and resume private conversation.
- Repeat if necessary.  
—OR—
- During a conversation, scroll to **Group Listen**.

NOTE: Depending on speaker volume and the acoustics of your office, it may be advisable to turn the group listening feature off before hanging up. This will eliminate a momentary squeal.

## ACCOUNT CODES

When enabled, your system allows calls to be charged to different accounts. You can enter account codes either by dialing the full code, by entering an account code "bin number"; or by pressing your **ACC (Account)** key if one is assigned. Bin numbers are a 3 digit short code that will automatically insert the appropriate account code. Account codes may be a maximum of 12 digits (# may be used); if the account code is to be less than 12 characters you may end the code by pressing \* or the right soft key. The type of code used is determined by your telephone system administrator. Codes can be entered before or during a call as follows:

### To enter an account code before placing the call:

- Press your **ACC (Account)** key or dial **47**.
- Dial the account code or bin number.
- You will receive a confirmation tone and display.
- When prompted dial a trunk or trunk group (i.e. 9) and the telephone number to call.

### To enter an account code by interrupting the conversation:

- While on an outside call press the **ACC (Account)** key or press **Transfer** followed by **47**.
- Dial the account number or bin number (if you are entering an account code you will need to press your **ACC (Account)** key or right soft key to finalize the entry).

NOTE: If you make an error simply repeat the procedure with the correct code. Only the most recent account code dialed will be recorded.

## LOCKING YOUR KEYSSET

You can lock your keyset to control misuse of your phone while you are away. You can unlock it when you return.

- Press **Menu** button and press **Phone** soft button.
- Scroll to **Security** option.
- Enter the **Password** [Default Password is "1234"]. Press **OK**.
- There are three options available:

**CHANGE PASSWORD:** This can be used to change the station password.

**CALL LOCK:** Allows the station user the option to select **Lock All**, **Lock Outgoing**, or **Unlocked**.

1. **UNLOCKED** - No restrictions. User may complete internal and outside calls.
2. **LOCK OUTGOING** - Restricted to incoming calls only. No outside calls can be made. When 911 is programmed, 911 emergency dialing is allowed.
3. **LOCK ALL** - No calls, incoming or outgoing allowed to or from the set.

**PHONE LOCK:** Allows the user to lock or unlock the menu from being changed at the station.

- Use the navigation soft button to scroll **Left/Right** to choose the desired mode.
- Press the **Save** soft button.
- Press the **Back** soft button to return to **Menu**, and press **Home** soft button again to return to idle screen.

## MANUAL SIGNALLING

Use this feature when you want to send a brief 500ms ring burst to another station, regardless of the status of your phone (on-hook, off-hook, handsfree, DND, or ringing).

### To send a signal to another station:

- Press the Manual Signalling (**MS**) button.
- You may press the **MS** button repeatedly to send multiple signals to the designated station.

NOTE: Your phone must have a Manual Signalling (MS) button with a station number extender assigned to it. Manual Signalling will override DND.



## OFF-HOOK VOICE ANNOUNCE

Keysets may receive a voice announcement while on another call. The calling station must have an **OHVA** button. When you are in DND, you cannot receive OHVA calls. The OHVA feature will work with intercom and transferred calls.

When you receive an OHVA and secure OHVA is ON, you will hear the announcement in the handset receiver, if you are using the handset. If secure OHVA is OFF then you will hear the announcement on the speaker, if you are talking on the handset. If you are using the speakerphone the announcement will always be heard through the speaker.

### To make an off-hook voice announcement:

- Dial the extension number or press the **DSS** button.
- When you receive a busy signal, press the **OHVA** button.
- After the attention tone, begin speaking.
- Finish the call by replacing the handset.
- Press the flashing **Call** button on your keyset. This will place the original party on hold and allow you to talk to the announcing party.
- To return to your first party, press the button corresponding to your original call. This will disconnect the OHVA call.

### NOTES:

1. When you are voice announcing to a station close to you, use the handset to avoid an echo effect.
2. You cannot off-hook voice announce to single line telephones.

## OHVA BLOCK

Your keyset can be programmed with an OHVA Block (**Block**) button. Pressing this button will prevent anyone from making an OHVA to you until you press the button again and cancel the blocking.

## OHVA REJECT

Your keyset can be programmed with an OHVA Reject (**Reject**) button. Pressing this button while receiving an OHVA call will disconnect the voice announcing party and return you to your original call.

## IN GROUP/OUT OF GROUP

If your keyset is assigned to a station ring group, you can remove your keyset from the group and then put it back in. While you are out of the group, you can receive calls to your extension number but not calls to the group number. If you have an **IO GRP (IN/OUT GRP)** button with the group number assigned.

- Press the **IO GRP (IN/OUT GRP)** button. The button indicator will be lit steady when your keyset is in the group.
- Press the **IO GRP (IN/OUT GRP)** button again to exit the group and the indicator will go blank. Repeat as necessary.

If you do not have an **IO GRP (IN/OUT GRP)** button:

- Dial the **IO GRP (IN/OUT GRP)** access code number \_\_\_\_\_, then the group number, then **0** to exit the group or **1** to enter the group.

NOTE: If the Hot Keypad feature has been turned off, you must first lift the handset or press **Call** soft button.

The **IO GRP (IN/OUT GRP)** button can include an extender to indicate the specific group that this button will affect. This means that if you are in multiple groups, you can decide for which groups you will receive calls.

# CUSTOMIZING YOUR KEYSSET

## AME PASSWORD

This feature allows customers using the AME feature to enable password protection. This will prevent unauthorized users from listening to your messages being left. The passcode is the same as your station passcode. This feature only applies if there is a Samsung Voicemail card installed in the system and your keyset has a programmed AME button.

- With the handset on-hook, press **Transfer** and then dial **110**.
- Dial **101** to turn on AME PASSCODE or **100** to turn it off.
- Press **Transfer** to store your selection.

## AUTO CAMP-ON

This option allows intercom calls to be automatically camped on, if possible, when a busy station is called.

- With the handset on-hook, press **Transfer** and then dial **110**.
- Press **081** to turn CAMP-ON on or **080** to turn it off.
- Press **Transfer** to store your selection.

## SELECT RING TONE

Each SMT-i5243 user can select from a variety of ring tones.

### From the LCD:

- Press **Menu** button, press **Phone** button.
- Scroll to **Sound** option.
- Select **Ring Tone**.
- Use **Navigation** button to scroll through the available ring tones and press **Save** soft button to store your selection.
- Press **Home** soft button to return to idle screen.

## CHANGE YOUR PASSCODE

From the factory, your station passcode is 1234. You can change your station passcode whenever you desire.

- While on-hook, press **Transfer** and then dial **101**.
- Dial your old passcode.
- Dial a new passcode (must be four characters). You can use **0-9**.

- Redial the new passcode. If successful, you will hear two beeps. Four beeps indicate an incorrect code to confirm, reenter the code again.
- Press **Transfer** to store the new passcode.

## SET ANSWER MODE (INTERCOM)

You can receive internal calls in one of three modes ([see Answering Intercom Calls under Intercom Calls](#) for descriptions).

- While on-hook, press **Transfer** and then dial **103**.
- Dial **0** for Ringing, **1** for Auto Answer or **2** for Voice Announce.
- Press **Transfer** to store your selection.

NOTE: When your keyset is programmed for Voice Announce and you have Forward No Answer (FNA) turned on, you must answer screened transfers by pressing the **OK** button before your FNA timer expires or the call will forward.

## SET ANSWER MODE (CO)

Your incoming CO calls can be set to follow the intercom answer mode.

- While on-hook, press **Transfer** and then dial **110**.
- Dial **15** to access **AUTO ANS CO**.
- Press the **Volume Up** [+] or **Volume Down** [-] key to change status.
- Press **Transfer** to store your selection.

## AUTOMATIC HOLD

While on an outside call, pressing a line button, route button or a flashing **Call** button will automatically put your call on hold and connect you to the next call. This feature can be turned on or off at your keyset.

- With the handset on-hook, press **Transfer** and then dial **110**.
- Dial **001** to turn Automatic Hold on or **000** to turn it off.
- Press **Transfer** to store your selection.

## HEADSET OPERATION

Keyset users can switch between headset mode and handset mode. When using headset mode, press the **Speaker** button to answer and **Speaker** button to release calls.

- With the handset on-hook, press **Transfer** and then dial **110**.
- Dial **021** to use the headset or **020** to use the handset.
- Press **Transfer** to store your selection.

Your keyset is equipped with a **Headset** button. Pressing this button while the indicator is off will cause the keyset to enter headset mode and the button indica-

tor to be lit solid to indicate this. Pressing the button while the button indicator is lit solid will cause the keyset to return to handset mode and the button indicator will go off.

NOTE: If you need to switch between headset mode and handset mode (or speaker phone) during a conversation, you will need to put the call on hold first.

## HOT KEYPAD

On your phone system your keyset's keypad can be made "live" or "hot" so that it is not necessary to lift the handset or press the **Speaker** button before you begin dialing. Calls can be made and features activated by simply dialing the C.O. line number, trunk group access code, intercom number or feature access code.

- With the handset on-hook, press **Transfer** and then dial **110**.
- Dial **031** to turn the Hot Keypad on or **030** to turn it off.
- Press **Transfer** to store your selection.

## KEY CONFIRMATION TONE

You can hear a short beep (confirmation tone) each time you press a button on the dial pad. This tone can be turned on or off.

- While on-hook, press **Transfer** and then dial **110**.
- Dial **040** to turn tones off or **041** to turn tones on.
- Press **Transfer** to store your selection.
- Additional ring tones can be selected from the **Menu, Phone, Sound, Keytone** option.

## REJOINING A PAGE

This feature allows you to hear the remaining portion of an ongoing internal page after you return your keyset to idle. To enable this feature:

- With the handset on-hook, press **Transfer** and then dial **110**.
- Dial **051** to turn this feature on or **050** to turn it off.
- Press **Transfer** to store your selection.

## RING PREFERENCE

This feature automatically answers ringing calls when you lift the handset. This method will always answer calls in the order they arrived at your keyset. When you turn ring preference off, you must press the flashing button to answer a call, allowing you to answer calls in the order you choose.

- With the handset on-hook, press **Transfer** and then dial **110**.
- Dial **061** to turn ring preference on or **060** to turn it off.
- Press **Transfer** to store your selection.

## DISPLAY SPEED DIAL NAME

This option allows you to view the name associated with a speed dial number as it is dialed.

- With you handset on-hook, press **Transfer** and then dial **110**.
- Press **111** to turn **DISP SPDNAME** on or **110** to turn it off.
- Press **Transfer** to store your selection.

## CALLER ID REVIEW ALL

This feature allows display keyset users to review Caller ID information for calls sent to their stations. This list can be from ten to fifty calls in a first in, first out basis. The list includes calls that you answered and calls that rang your station but that you did not answer. When reviewing this list, you can press one button to dial the person back. The system must be using LCR to dial the stored number.

- With you handset on-hook, press **Transfer** and then dial **110**.
- Press **121** to turn **CID REVIEW ALL** on or **120** to turn it off.
- Press **Transfer** to store your selection.

## SECURE OHVA

This option allows you to receive OHVA (Over Head Voice Announce) calls via the speaker while you are on the handset.

- With your handset on hook, press **Transfer** and then dial **110**.
- Press **131** to turn **SECURE OHVA ON** or **130** to turn it **OFF**.
- Press **Transfer** to save your selection.

## CONFIGURE MOBILE EXTENSIONS [MOBEX]

This feature allows you to configure options for any Mobile Extension (MOBEX) ports that are assigned to you by your telephone system administrator. You can turn a port on or off; set the telephone number for the port; or set the caller ID you will be calling in from. The caller ID field has no effect unless you have been authorized as an Executive MOBEX user. Check with your telephone system administrator for further details on your specific system configuration.

**To set the phone number a MOBEX port can reach you on:**

- Press **Transfer** and then dial **126**.
- Dial your station pass code.
- Dial the number of the port you wish to configure (1-5) (you may also use the **Volume Up** [+] or **Volume Down** [-] keys to select a port and press the **Right** soft key to confirm).
- Press **Right** soft button to move to telephone number.

- Dial the number of a C.O. line or trunk group to use when making calls to this MOBEX port.
- Dial the phone number you can be reached at by users calling this MOBEX port.
- Press **Transfer** to store your selection and exit programming.

#### To set the caller ID of the location you will be calling in from:

- Press **Transfer** and then dial **126**.
- Dial your station pass code.
- Dial the number of the port you wish to configure (1-5) (you may also use the **Volume Up** [+] or **Volume Down** [-] keys to select a port and press the right soft key to confirm).
- Press **Right** soft button twice.
- Dial the contact number.
- Press **Transfer** to store your selection and exit programming.

#### To turn a MOBEX port ON or OFF:

- Press **Transfer** and then dial **126**.
- Dial your station pass code.
- Dial the number of the port you wish to configure (1-5) (you may also use the Volume Up and Volume Down keys to select a port and press the **Right** soft key to confirm).
- Dial **2** to select the activation status option.
- Dial **0** to turn the port on, dial **1** to turn the port off.
- Press **Transfer** to store your selection and exit programming.

## DISPLAY FEATURES

### DIRECTORY INFORMATION

An 11 character directory name can be assigned to each extension number. Display keyset users can view the name of the called or calling station before answering.

Each outside line can have an 11 character directory name. Incoming calls can be easily identified and answered with different greetings.

Outside and internal calls ringing to a station group will display [CALL FOR xxx] where xxx is the station group number. This allows you to answer calls directed to you differently than calls directed to your group.

### DISPLAY NUMBER DIALED

Display keysets begin showing digits as they are dialed. They will stay in the display until the call duration timer comes on automatically or the **Timer** button is pressed. If the call duration timer is not used, the number dialed will be displayed until the call is released, transferred or put on hold.

### CALL DURATION TIMER

The system can be set to automatically time outside calls. A few seconds after you dial a telephone number, the timer appears in the display. It appears immediately for incoming calls. The call timer continues for the duration of the call. Call duration times are displayed in minutes and seconds. If a call lasts longer than 60 minutes, the timer restarts.

You can press the **Timer** button to manually begin timing a call. Press it again to stop timing. If you press it while the automatic timer is on, the call duration time is restarted.

### AUTO TIMER

Display keyset users may have the timer automatically start when they answer incoming calls or after a short delay on an outgoing call.

- With the handset on-hook, press **Transfer** and then dial **119**.
- Dial **41** to turn the auto timer on or **40** to turn it off.
- Press **Transfer** to store your selection.

## TIMER FUNCTION

Display keyset users may use this feature as a simple stopwatch.

- When the keyset is idle, press the **Timer** button to start timing.
- Press the **Timer** button again to stop timing.
- Read the elapsed time in the display.
- Lift the handset and replace it. The display will return to date and time.

## VIEWING STATION MESSAGE INDICATIONS

You can view all of your message indications before you return them:

- With the handset on-hook, press the **Message** button with the flashing indicator.
- Scroll to **Station Message** and press **OK**.
- The first station that left a message indication will be displayed.
- Press the **Volume Up** [+] or **Volume Down** [-] keys to scroll through the stations that left message indications. Use the soft keys to reply, clear or advance to the next message.
- Press the **End** button to return your keyset to the idle condition.

## PERSONAL SPEED DIAL NAMES

Each personal speed dial number can have an 11 character name assigned to it. This name is used to select the speed dial bin when you are dialing by directory.

- Press **Transfer** and then dial **106**.
- Dial the speed dial bin number **00–49**.
- Using the dial pad, enter the station name. ([See Station Names](#))
- Press the **Transfer** button to store the speed dial name.
- Repeat for each speed dial bin if necessary.

NOTE: Use the Navigation button to move the cursor left or right, and use the **Volume Up** [+] or **Volume Down** [-] buttons to increment the speed dial bins.

[See Programming Personal Speed Dial Numbers Section.](#)

## STATION NAMES

- With the handset on-hook, press **Transfer** and then dial **104**.
- Enter the **Station Name**. Use the **Volume Up** [+] or **Volume Down** [-] buttons to move cursor.
- Press **Transfer** to store the name.  
—OR—
- Press **Menu** button, select **Settings** soft button.
- Select **Call**, scroll to **Phone Name**.

- Select **Phone Name**.
- Enter **Station Name**. Use the **Navigation** button to move cursor.
- Press **OK** and then **Save** soft button to store the name.

## MANAGING PROGRAMMABLE KEY ASSIGNMENTS

You can manage your programmable key assignments for easy one touch operation of frequently used features.

- Press the **Function** button to display the current key assignments.  
—OR—
- While on-hook, press **Transfer** and then dial **107**.
- Use the **Volume Up** [+] or **Volume Down** [-] buttons to scroll through all of your programmable buttons.
- Press **Transfer** to exit programming.

To program the programmable keys, press **Menu, Settings, Application Settings, AOM Setting**.

For example:

**If you want to press a key that will direct calls to Joel at extension 3201.** Select an empty key and set the following:

- Feature: DSS
- Ext. Number: 3201
- Display Name: Joel

**If you want to press a key that will direct calls to Sue's external phone number at 972-444-3456.** Select an empty key and set the following:

- Feature: Speed
- Ext. Number: 01
- Display Name: Sue
- Use Transfer 105 to set speed dial number: [xxxx] SPEED DIAL  
01: 9-9724443456

Please consult your installation company to requested a complete list of descriptions for any keys you may have programmed on your keyset.

NOTE: Confirm that the cursor is placed correctly before you enter the extender.

## BACKSPACE WITH LCR

If you misdial while using LCR, you can delete digits shown in the display by pressing the **Backspace** soft button as many times as necessary or by pressing **Clear** to delete all.

# CALLER ID

## SELECTING YOUR CALLER ID DISPLAY

Simultaneous display of Caller ID name and number on incoming CO calls on both lines of display keysets is supported on all OfficeServ systems. On Transferred CO calls, you can decide if you want to see the Caller ID name or Caller ID number in the display. Regardless of which data is selected, you can press the NND button to view the other pieces of Caller ID information. To select the type of Caller ID information you wish to view:

- With the handset on-hook, press **Transfer** and then dial **119**.
- To set the first line of a ringing call display dial **0**.
- To set the second line of a ringing call display dial **1**.  
Set the data to display from the following:
  - To show nothing dial **0**.
  - To show Caller ID Number dial **1**.
  - To show Caller ID Name dial **2**.
  - To show the DID Number the call came in on dial **3**.
  - To show the Name of the DID the call came in on dial **4**.
  - To show the Name of the Group the call came in for dial **5**.
  - To show the DID Number and then Name of the DID dial **6**.
  - To show the Name of the DID and then the DID Number dial **7**.
- To set the top line of the display shown after answering a call dial **2**.  
Set the data to display from the following:
  - To show Caller ID Number dial **0**.
  - To show Caller ID Name dial **1**.
  - To show the DID Number the call came in on dial **2**.
  - To show the Name of the DID the call came in on dial **3**.
  - To show Caller ID Number and then the DID Number dial **4**.
  - To show Caller ID Name and then the DID Number dial **5**.
  - To show the DID Number and then the name of the DID dial **6**.
  - To show the Name of the DID and then the DID Number dial **7**.
  - To show the C.O. line information dial **8**.
- To set the format if the C.O. line information when the above is set to show C.O. line information dial **3**.
  - To show the C.O. line number and the dialed or Caller ID Number dial **0**.
  - To show only the dialed or Caller ID Number dial **1**.
- Press **Transfer** to exit and store your selection.

## VIEWING THE NEXT CALLER ID CALL

In the event that you have a call waiting or a camped-on call at your keyset, you can press the **Next** button to display the Caller ID information associated with the call in queue at your keyset. Either the CID name or CID number will show in the display depending on you Name/Number selection.

To view Caller ID information for calls that have been camped-on to your keyset, press the **Next** button.

## INQUIRE CALLER ID PARK/HOLD INFO

If you are informed that an incoming call is on hold or has been parked for you, you may view the Caller ID information before you retrieve the call. This may influence how you choose to handle the call.

### From an idle keyset:

- Press the **Inquire** button—**OR**—press **CID** button.
- Dial the trunk number.
- You may now answer the call by pressing the **Answer** button—**OR**—**Name/Number** to view more information about this call—**OR**—you can return to the idle condition by pressing **Ignore**.

### If you are on a call:

- Press the **Inquire** button. Your existing call will go on hold.
- Dial the trunk number.
- You may now answer the call by pressing the **Answer** button—**OR**—you may use **Name/Number** to view more information about this call—**OR**—you can return to the idle condition by pressing **Ignore**.

### NOTES:

1. If you are on an intercom call or you have Automatic Hold turned off, you must finish the existing call or place it on hold before inquiring.
2. If you inquire about an outgoing call, you will receive a [call no longer available] display.

# FEATURE ACCESS CODES

## Paging Zones - Dial 55 plus

- 0 \_\_\_\_\_
- 1 \_\_\_\_\_
- 2 \_\_\_\_\_
- 3 \_\_\_\_\_
- 4 \_\_\_\_\_
- 5 \_\_\_\_\_
- 6 \_\_\_\_\_
- 7 \_\_\_\_\_
- 8 \_\_\_\_\_
- 9 All External Zones
- \* All Page

## Feature Access Codes

- |              |                           |           |                            |
|--------------|---------------------------|-----------|----------------------------|
| 0            | Operator                  | 56        | Meet Me Answer             |
| 10 + xxx     | Pick Up A Parked Call     | 600       | Cancel All Call Forward    |
| 12 + xxx     | Pick Up a Held Call       | 601 + xxx | Set Forward All Calls      |
| 13           | Door Lock Release         | 602 + xxx | Set Forward Busy           |
| 16 + xxx     | Speed Dialing             | 603 + xxx | Set Forward No Answer      |
| 17           | Save And Redial Number    | 604 + xxx | Set Forward Busy/No Answer |
| 18           | New Call (Recall)         | 605 + xxx | Set Forward on DND         |
| 19           | Last Number Redial        | 606 + xxx | Set Forward Follow Me      |
| 400          | Cancel Do Not Disturb     | 65 + xxx  | Pick Up Ringing Extension  |
| 401          | Do Not Disturb            | 66 + xx   | Pick Up Group              |
| 42 + xxx     | Cancel Sent Message       | 67        | Universal Answer           |
| 43           | Return Message            | *         | Authorization Code         |
| 44           | Callback                  |           |                            |
| 45           | Busy Station Camp-On      |           |                            |
| 46           | Conference                |           |                            |
| 47           | Account Code              |           |                            |
| 48 + xx      | Cancel Programmed MSG     |           |                            |
| 49           | Send Flash to C.O. or PBX |           |                            |
| 53 + xxx + 1 | In Group                  |           |                            |
| 53 + xxx + 0 | Out of Group              |           |                            |

## SECTION 6. APPLICATIONS

# Samsung Voicemail

This section describes how to setup and use the various features available to a Subscriber. A Subscriber is a person that has been authorized access to the various features and services available in the Samsung Voicemail. Please review this section carefully before you use your Authorized Features and Services, known as Subscriber Services.

Voice Mail is one of the Subscriber Services available. Your voice mail box has the capability of storing private messages, and offers a number of options for sending or redirecting messages as well as provides several ways to notify you of new messages.

Another very common Subscriber Service is Access Manager. This allows you control over when and where you receive your calls as well as what to speak to your callers in the event you are unable to speak to them directly. The 'events' are referred to as "Call Conditions". No-Answer, Busy, and Blocked are the most commonly used Call Conditions.

This guide can be used by Subscribers from within the office or from telephones outside the office. The basic operation is the same, but the access method will be different. [See the Subscriber Services Menu Diagram for more details.](#)

Note that some features and prompts detailed here may not be available to all Subscribers. See your System Administrator if you have questions about feature availability.

## ACCESSING YOUR MAILBOX

*[Also known as Subscriber Services Menu]*

### Inside Callers *[Subscriber logging in from their Desk]*

- Dial the voicemail access number or press the key assigned to ring voicemail **[VMMSG]**.
- Enter your personal password when prompted (the default password is 0000).

### Outside Callers *[Subscribers calling from Cell Phones or outside of the office environment]*

- Dial the phone number that will be answered by the voicemail. The main greeting will answer.
- At the main greeting dial **[#]** plus your Subscriber (or mailbox) number (Subscriber and Mailbox numbers will usually match your extension number).
- Enter your personal password when prompted (the default password is 0000).

### Access your Subscriber Services (or Mailbox) from a Station other than your Own (or checking a mailbox associated with a different station)

- Press the **[VMMSG]** key or dial the voicemail **group number**. You will be prompted to enter a password.
- Press **[\*]**. This will take you to the Main Auto Attendant Menu.
- Press **[#]** plus the Subscriber number of your choice. You will be prompted to enter your password.

At this point the inside and outside callers follow the same instructions. You will hear a message stating the number of messages left in your mailbox. You will then hear the Subscriber Services Menu with the following options:

- 1 Listen to New Messages - [See Listening to your Message.](#)**
  - 2 Record and Send Message - [See Sending Messages.](#)**
  - 3 Review Saved Messages - [See Listening to your Message.](#)**
  - 4 Access Manager - [See Access Manager.](#)**
  - 5 Personal Greetings - [See Personal Greetings.](#)**
  - 6 Mailbox Administration - [See Mailbox Administration.](#)**
- # Personal Services - [See Personal Services.](#)**
- \* Return to Main Menu.**

**Voicemail and the Function Soft button:** When accessing and retrieving voice-mails from the mailbox, the service options such as **(1) Listening to Messages**, **(2) Record and Send Messages**, and **(3) Review Saved Messages** are available and can be accessed through the dial pad or through the **Function** soft key. When pressing the function soft button the options will be displayed. Scroll to and press the **OK** button to select an option from the **Function Menu**.



# Subscriber Services Menu

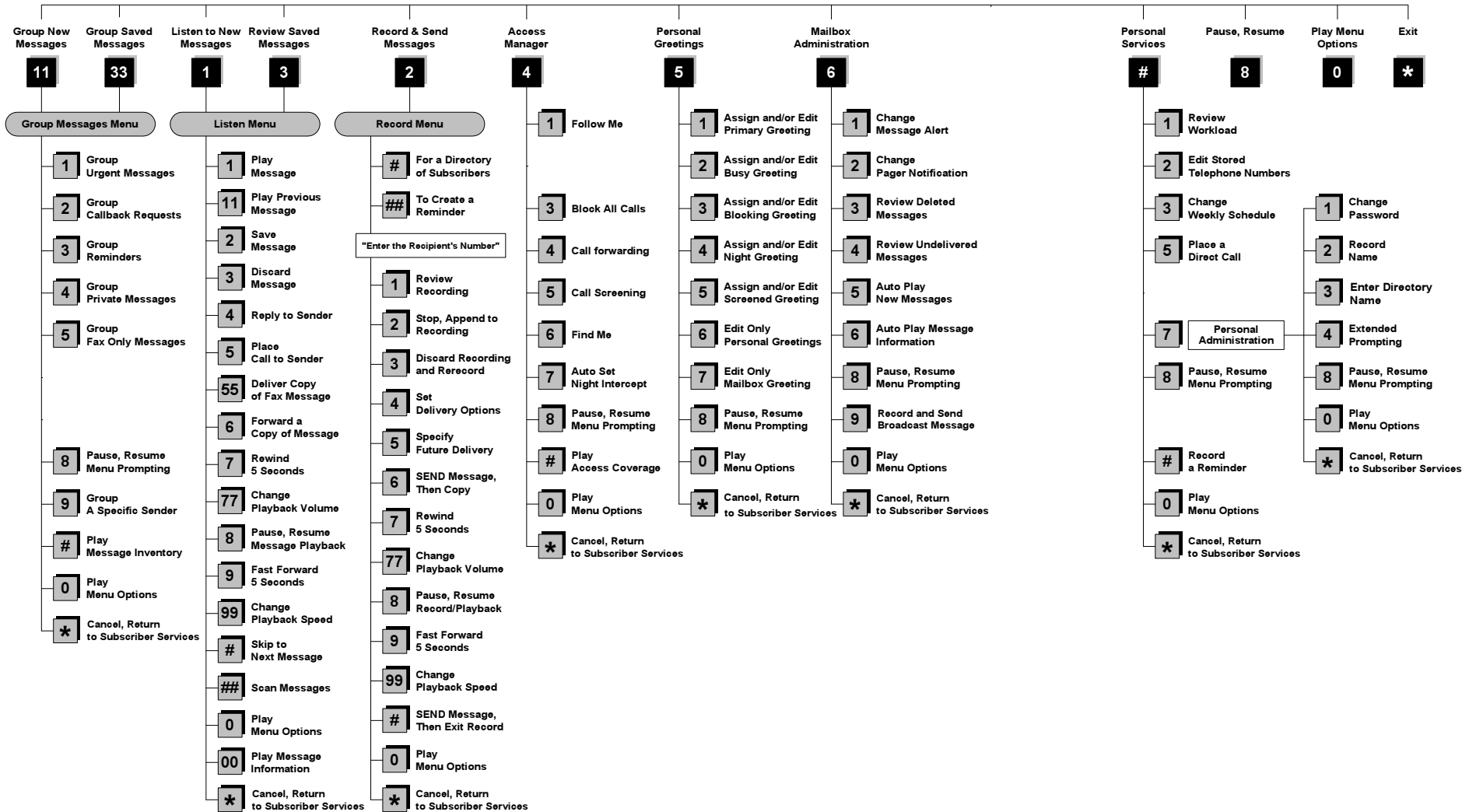

NOTE: All options shown MAY NOT be authorized. If an option is not available please speak to your system administrator.

\*Change Playback Speed and Volume not available on the OfficeServ 7030, OfficeServ 7100, OfficeServ 7200-S or OfficeServ IP-UMS.

## GETTING STARTED

Using your new Samsung Voicemail Subscriber Services is as simple as following a few simple spoken instructions. First time users should read this section as a tutorial. You should start with the following steps:

- Access your Subscriber Services Menu - You already know how to do this.

### From the Subscriber Services Menu:

- Record a Primary/No-Answer Personal Greeting. Dial **[5][1]**.
- Record a Mailbox Greeting. Dial **[5][7]**.
- Change your access code (Password). Dial **[#][7][1]**.
- Record your name. Dial **[#][7][2]**.
- Enter your directory name. Dial **[#][7][3]**.

After you have completed the steps above your Subscriber Services are set up and ready to use.

## LISTEN TO YOUR MESSAGES

If there are new messages in your mailbox your **[VMMMSG]** key will be lit. Call the Samsung Voicemail by pressing this key, and when prompted enter your password. You will then be at the Subscriber Services Menu. Select **[1]** to listen to new messages or **[3]** to listen to saved messages.

Note: After you enter your password, if "Autoplay of New Messages" is enabled and you have new messages the Samsung Voicemail will begin to play them automatically. A subscriber can control this feature. From the Subscriber Services Menu **[6][5]** toggles "Autoplay of New Messages" ON/OFF.

## SUBSCRIBER SERVICES MENU

The following is a list of all the options available in the Subscriber Main Menu.

- 1** LISTENING TO NEW MESSAGES
- 11** GROUP NEW MESSAGES
- 2** RECORD AND SEND A MESSAGE
- 3** LISTENING TO OLD MESSAGES
- 33** GROUP OLD MESSAGES
- 4** ACCESS MANAGER
- 5** PERSONAL GREETINGS
- 6** MAILBOX ADMINISTRATION
- 8** PAUSE / RESUME
- 0** PLAY MENU OPTIONS
- \*** EXIT TO AUTO ATTENDANT
- #** PERSONAL SERVICES

## 1 or 3

## LISTENING TO OLD OR NEW MESSAGES

- 1** Play / replay the message you just heard.
- 11** Play the previous message.
- 2** Save the message you just heard and listen to the next message.
- 3** Delete the message you just heard and listen to the next message.
- 4** Reply to the message.  
This will allow you to leave a message in the mailbox of the sender (if the sender has a mailbox on this system).
- 5** Return the call directly to the telephone number that left the message.  
This will work for internal and external callers, but Caller ID service is needed to use this feature on an outside call.
- 55** Deliver a fax copy.  
This will allow you to receive attached faxmail document(s). Faxmail documents can be delivered to any fax machine of your choice as long as out calling is authorized. You can also have faxmail messages automatically delivered to the fax machine of your choice.
- 6** Forward the message and saves a copy.  
The subscriber can be selected by dialing their mailbox number (nnn), using the directory service (#) or you may also add comments and leave it as a memo to yourself (##).  
The Send and Copy Service (option 6) allows a user to send copies of a message to multiple recipients easily. A different introduction message may be left for each recipient.
- 7** Rewind the message 5 seconds.
- 77** Change playback volume of the recording. **[Not available on the OS 7030, OS 7100, OS 7200-S or OS IP-UMS]**  
There are two levels of volume during playback. Dialing this code will toggle between the two levels.
- 8** Pause or resume during message playback.
- 9** Fast forward the message 5 seconds.
- 99** Change playback speed of the recording. **[Not available on OS 7030, OS 7100, OS 7200-S or OS IP-UMS]**  
There are two levels of speed during playback. Dialing this code will toggle between the two speeds.

- 0** Play options.  
Pressing this key will play all the menu options available to you from this point.
- 00** Hear the time and date, and sender's information of the message you just heard. Sender information is not available on outside calls.
- #** Move to the next message. This does not Save or Discard the current message - it is retained as new.
- ##** Scan. Plays first 7 seconds of a message then skips to next message. This is similar to the scan button on a radio. It will allow you to find a specific message quickly. To stop scanning press **[1]**.
- \*** Cancel and return to previous menu.

**11** or **33**

## GROUP NEW OR OLD MESSAGES

Messages can be grouped as either Reminders, press **[3]** or Messages from a specific sender, press **[9]**.

Additionally you can press **[#]** and hear a summary of your mailbox contents:

- a) Number of messages
- b) Number of reminders
- c) Number of urgent messages
- d) Number of messages needing a callback
- e) Number of private messages
- f) Number of fax messages

**2**

## RECORD AND SEND A MESSAGE

This option is used to send a message to another subscriber. The steps are simple:

- a) Enter the recipient's mailbox number, or if this is not known enter **[#]** to use the system directory.
- b) Record your message at the tone. After recording the message, you will hear the Send Menu with the following functions:
  - 1** Review
  - 2** Continue Recording

- 3** Discard and Re-Record
- 4** Set Message Attributes (Delivery Options)
- 5** Schedule Future Delivery
- 6** Save and Send then Send a Copy to Someone Else
- #** Save and Send the Recording

## Setting Message Attributes

If after recording a message you select **[4]** you can set up any combination of the following delivery options:

- 1** Urgent Delivery
- 2** Return Receipt Requested
- 3** Request a Call Back
- 4** Private Delivery
- 5** Reply Required
- \*** Exit

## Scheduling Future Delivery

If after recording a message you select **[5]** to schedule future delivery, you will be able to set message attributes and set this message as:

- #** Immediate Delivery
- 1** Next Few Hours
- 2** End of Current Business Day (based on your Availability Schedule)
- 3** Beginning of Next Business Day (based on your Availability Schedule)
- 4** A Coming Day of the Week
- 5** Specific Day / Time
- \*** Exit

# 4

## ACCESS MANAGER

The Access Manager allows the subscriber to set a number of options for when, where and how, and/or if the Samsung Voicemail contacts you when a caller dials your extension number. All of the options are toggled on/off based on their current status when you access them.

**Note:** ALL Access Manager options **MUST** be individually allowed by the System Administrator for each Subscriber. They are:

### 1 Follow Me

Allows the subscriber to enter an alternate location and set how long the new destination (Designated Location) will be active. This number may be an internal or external number. This is useful if you are frequently traveling or changing the number where you can be reached.

When Follow Me is activated, the transfer will be supervised and confirmed. This means that if the call is not answered or if rejected by the Subscriber at the designated location it will be recalled to the Subscriber's mailbox.

### 3 Call Blocking

When this feature is active, callers will not be transferred to your extension, they will hear your 'blocked' greeting (if recorded) and will go directly to your mailbox if they do not select any or are not offered any other options.

### 4 Call Forwarding

Unlike Follow Me where the subscriber wants to take their calls at an alternate location this feature allows the subscriber to pass control of his calls to another Subscriber. The "Forwarded To" Subscriber will now be in control of the caller and the caller will NOT return to originating Subscriber's Mailbox. If the "Forwarded To" Subscriber does not answer the caller it will now follow whatever the "Forwarded To" Subscriber has set up for their call conditions. The Caller will hear "Forwarding to" "{Subscriber Name}" before actually being forwarded.

### 5 Call Screening

If this is turned on, the caller will be asked their name and the Samsung Voicemail will play this name to you before the transfer, giving you an option to accept or reject the call.

### 6 Find Me

Find Me, when enabled, will attempt to locate the subscriber by calling a list of preprogrammed phone numbers. The stored phone numbers are entered in 'Personal Services' [#][2] (if allowed by the Administrator). The stored telephone number list can contain up to 9 preprogrammed telephone numbers. The Find Me feature only use the first five.

### 7 Night Intercept

This feature is dependent on your weekly availability schedule, which is entered in 'Personal Services' [#][3] (if allowed by the Administrator). When Night Intercept is active the Samsung Voicemail will first ring your extension then play your primary, No Answer greeting during the day (when you are available) and will NOT ring your extension but simply play your Night greeting during the night (when you are not available).

**Note:** This does NOT use the Day and Night schedules of the phone system. It is solely controlled by the Subscriber's Availability Schedule.

### 8 Pause / Resume

#### \* Exit from Access Manager

#### 0 Play All Options

#### # Play Access Coverage

This feature is useful for finding out how you current access settings are set. It will also tell you what greetings will play under each of the call conditions you have setup.

# 5

## PERSONAL GREETINGS

The options available in this menu will be determined by your System Administrator, and not all of them may be available to you. In the simplest systems, only a mailbox greeting will be available, additional greetings may be accessible in more complex systems.

Your Personal Greeting will be played every time someone dials your extension and you do not answer.

You may record up to 9 Personal Greetings, and you may assign any one of them to be active. There are several different 'Call Coverage' conditions to which you may assign any of your 9 greetings. The Call Coverage Conditions are: No-Answer, Busy, and Do Not Disturb (or Forwarded All). This will allow different greetings to play depending on the type of call forward that you have set, or the condition of your telephone.

The Call Coverage conditions that you can assign specific greetings to are selected by the following digits:

### **1 Primary/No Answer Greeting**

Used when in your office, away from your desk or during the time period you are scheduled available. If this is the only Personal Greeting you record, it will play for all call coverage conditions.

This option is available only if the Administrator has assigned you the 'Basic Greeting' feature.

Example: "Hi this is John Smith. I'm sorry I am not available to answer your call. If someone else can help you, please enter the extension number now. Or, to leave me a message, press 1."

### **2 Busy Greeting**

Played to a caller when you are already talking to someone on your extension or the telephone at your Designated Location.

This option is available only if the Administrator has assigned you the 'Busy Greeting' feature.

Example: "Hi, this is John Smith. I'm on another line right now. If someone else can help you, please enter the extension number now. Or, to leave a message, press 1."

### **3 Call Blocking Greeting**

Used while Call Blocking is enabled in your Access Manager or if your phone is forwarded ALL or DND.

This option is available only if the Administrator has assigned you the 'Call Blocking' feature.

Example: "Hi, this is John Smith. Sorry I missed your call, but I'm going to be out of the office for the next few hours. If someone else can help you, please enter the extension number now. Or, to leave me a message, press 1."

### **4 Night Greeting**

Used during the time period you are scheduled UNAVAILABLE, usually after business hours during the evening and at night.

This option is available only if the Administrator has assigned you the 'Scheduling' feature.

Example: "Hi, this is John Smith. I've left the office for the evening. If you would like to try someone else, please enter the extension number now. Or, to leave me a message, press 1."

### **5 Call Screening Greeting**

Used while Call Screening is enabled, and you REJECT a caller after listening to the caller's record name.

This option is available only if the Administrator has assigned you the 'Call Screening' feature.

Example: "Hi, this is John Smith. I'm sorry, but I am not available to speak with you at this time. If someone else can help you, please enter the extension number now. Or, to leave me a message, press 1."

### **6 Edit Personal Greetings**

You may also edit/record each one of the greetings (1-9) at any time.

Select a greeting number to edit and follow the instructions to record your greeting. When you are done recording your greeting, you will be able to listen to the greeting you recorded, save the greeting you recorded and return to the previous menu, record the greeting again, or exit without saving the greeting.

Note: If you record only the greeting assigned to the No-Answer Call Coverage Condition, then that greeting will play to callers for all Call Coverage Conditions (No-Answer, Busy, Blocked, Night, and Rejected Caller). In this case, the salutation part of the greeting should be very general.

### **7 Edit Mailbox Greeting**

Used whenever a caller reaches your mailbox or if you have not recorded any of the Call Coverage greetings. The way a caller is transferred to your mailbox greeting directly, is by another subscriber transferring the caller to your mailbox using the VT (VoiceMail Transfer) key.

This option is available only if the Administrator has assigned you the 'Mailbox Greeting Option' feature.

Example: "Hi, this is John Smith. Please leave me a message, I will call you as soon as I can."

Note: This greeting will only play if none of the 5 personal greetings has played to the caller. A common usage for this Greeting is when another Subscriber is talking with a caller and uses the VT key on their phone to transfer the caller directly to your Mailbox.

## MAILBOX ADMINISTRATION

The Mailbox Administration menu is used to turn on and off your pager notification, message alert options and other message control features.

### 1 Message Alert

When this function is activated, the Samsung Voicemail will call any outside or inside telephone number, after each message is left in your voice mailbox.

To hear your message at the remote location when the Samsung Voicemail calls you, after you pick up the telephone and answer you will be instructed that there is a message and to enter your password. Simply enter your password and you will now be logged in.

#### Setting Up Message Alert:

- From the Subscriber Services Menu press **[6]** for Mailbox Administration.
- Press **[1]** for Message Alert.
- There are 4 options available to you:
  - Press **[1]** to toggle message alert on and off.
  - Press **[2]** to set the schedule when you would like to be notified.
  - Press **[3]** to be notified on urgent messages only.
  - Press **[4]** to set the destination phone number.

### 2 Pager Notification

When this function is activated, the Samsung Voicemail will call your beeper service and notify you after each message is left in your voice mailbox.

- From the Subscriber Services Menu press **[6]** for Mailbox Administration.
- Press **[2]** for pager notification.
- There are 4 options available to you:
  - Press **[1]** to toggle pager notification on and off.
  - Press **[2]** to set the schedule when you would like to be paged.
  - Press **[3]** to be notified on urgent messages only.
  - Press **[4]** to set the pager phone number.

### 3 Undelete

When this function is activated, the Samsung Voicemail will allow you to undelete any messages that you have recently deleted (up to the programmed Daily Maintenance Time, which is set to 3 a.m. by Default the following morning).

- From the Subscriber Services Menu press **[6]** for Mailbox Administration.
- Press **[3]** for Deleted Messages.

Deleted voice mail messages are temporarily stored in memory until 3 a.m. the following day. Select this option to recover ("undelete") previously deleted messages, during this period of time.

### 4 Undelivered Retrieval

When this function is activated, the Samsung Voicemail will allow you to recall any messages you have sent that have NOT yet been picked up by the recipient.

- From the Subscriber Services Menu press **[6]** for Mailbox Administration.
- Press **[4]** for Undelivered Messages.

This useful feature will allow you to cancel any messages that have NOT yet been picked up by the recipient.

### 5 Auto Play New Messages

If this option is enabled, after you enter your password correctly any new messages will immediately begin to play. To enable (or if already enabled toggle and disable) this feature:

- From the Subscriber Services Menu press **[6]** for Mailbox Administration.
- Press **[5]** to Set Auto Play of New Messages.

### 6 Auto Play Message Information

If this option is enabled, the date, time and sender's name will be played automatically before each message. If this is disabled, the information must be requested manually by pressing '00'. To enable (or if already enabled toggle and disable) this feature:

- From the Subscriber Services Menu press **[6]** for Mailbox Administration.
- Press **[6]** to Set Auto Play of Message Information.

## MESSAGE BROADCAST

This option will only be available if it has been allowed by the System Administrator.

### Broadcast to All Mailboxes

If you have been designated as a Subscriber Administrator, you may send a message to ALL mailboxes in the system.

- From the Subscriber Services Menu press [6] for Mailbox Administration.
- Press [9] for Broadcast Messages.

This option will only be available if your mailbox has been assigned Subscriber Administration privileges.

## PERSONAL SERVICES

The Personal Administration Menu is used to set your password and record your name. Many of these features must be allowed by the System Administrator.

### 1 Workload Management

Allows you to access to all reminders, both Active and Pending. If authorized you can group your reminders as Commitments, Follow-Ups or Tasks for better organization. The system will flag each reminder as Active or Pending (pending means scheduled for future delivery).

### 2 Stored Numbers

Allows you to enter up to 9 stored phone numbers. The first five of these are used in the 'Find Me' feature, but any of them (1-9) can be easily dialed using only one digit followed by the pound key, to be used by many other features from within your subscriber space. (ie: "Follow Me," "Message Alert," "Pager Alert," and "Direct Call").

### 3 Schedule Availability

Allows you to enter a weekly availability schedule for use with Night Personal Greeting and the Auto Night Intercept feature. Follow the spoken directions

to enter the days of the week and times you are generally available to talk to your callers. All other times you will be considered unavailable.

### 5 Place a Direct Call

Allows you to place a direct call out of the Samsung Voicemail from anywhere. You may either dial the number or dial a single digit 1-5 that corresponds to a stored number ([See Personal Services, 2 - Stored Numbers](#)). This feature must be authorized by the System Administrator and can be limited or opened to internal, local, and long distance calls.

### 7 Personal Administration

This area is used during the initial set up of your Subscriber Settings ([see next section](#)).

## PERSONAL ADMINISTRATION SETTINGS

This menu allows you to make changes to basic setup settings, that are rarely changed. Use these when you initially set up your personal Subscriber settings. You probably will not need to change them after that.

### 1 Setting your Password

- From the Subscriber Services Menu press [#][7][1].
- The current password will be played and you will have the chance to change it.

### 2 Recording your Name

Use this option to record your name. Your recorded name is played in several different situations. It is important to record your name for proper operation of the Samsung Voicemail system.

- From the Subscriber Services Menu press [#][7][2].
- The current name will be played and you will have the chance to change it.

Note: It is possible that if you do not record your name and/or enter your Directory Name (described below), you will not be included in the Dial by Name Directory.

### 3 Entering your Directory Name

Use this option to enter your Directory Name. Your Directory Name is used by callers to find you if they do not know your extension number.

- From the Subscriber Services Menu press [#][7][3].

- The current Directory Name will be played as a string of digits that are equal to your name spelled out on your telephone keypad. Follow the instructions to enter a new name. You will be prompted to enter your last name and then your first name.

This must be done in order for the directory feature to work correctly.

Note: It is possible that if you do not record your name (described above) and/or enter your Directory Name, you will not be included in the Dial by Name Directory.

#### 4 Extended Prompting

Use this option to drastically reduce the number of prompts played in the subscriber interface (mailbox prompts). Change this setting only if you are very familiar with the user operation of the SVMi E-Series.

Note: Remember if you know what digits to press, you can enter them at any time you do not have to wait to be prompted. This feature can be toggled on/off at anytime. Also if it is off you will be prompted within each subscriber menu to press zero for more options. This enables you to still be able to find out what to do if you were to get lost and extended prompting was disabled.

## KEYSET USER FEATURES

The following options are available if you have a display keyset. They require setup by the System Administrator.

### Message Waiting Lights

When new messages are left in your mailbox, the voice mail message light on your keyset will flash. Press this flashing key [**VMMSG**] and follow the prompts to retrieve messages. This key may be pressed at any time to log into your Subscriber Main Menu.

### Answer Machine Emulation

If you have an Answer Machine Emulation key programmed on your keyset, you can use it to monitor calls going to your voice mail, and optionally answer them. The operation of this feature is similar to screening a call on a home answering machine.

Your keyset must be set to forward on no answer to voice mail. After ringing your station the caller will be connected to your voice mail and hear your personal greeting before leaving a message. During this time you will be monitoring the connection between the caller and your voice mail box. At this time you will only be monitoring the call, you can not talk to the other party until you answer. You may pick up the call at any time or ignore it.

To activate this feature press the **AME** button. The associated indicator will be lit steady. Press again to turn off. If this key is pressed while a station is ringing (during forward no answer), the feature will be turned on for the current call only.

While the caller is leaving a message or ringing you may:

- Press [**#**] to immediately put the caller in your voice mailbox and monitor it.
- Press [**\***] to immediately disconnect your station. The caller continues to leave a message normally.
- Pick up the handset and monitor privately.
- Press **ANS / RLS** to answer the call (using the handset or speaker).

### AME Password

If your keyset has **AME PASSWORD** (MMC 110) set to **YES**, you must enter your station password to listen to messages being left. This will prevent unauthorized people from listening to messages being left for you.

If the password option is turned on, while a message is being left, press the flashing **AME** indicator and enter your station password (not your SVMi E-Series password). You will then hear the message being left.

### Call Record

If you have a call record button assigned to your phone, you may press it at any time, to record the conversation in progress. If you have a display keyset, you will also have the soft key options to pause and time the message.



## SHORTCUTS

### Calling

Calling a station that is busy or does not answer you can press [#] to immediately send the call to the called parties mailbox.

### Call Divert to Voicemail

While receiving an incoming (ringing) call, dial [\*] to immediately send the caller to your personal voicemail box. This will override the call forward no answer setting.

### Direct Messaging

[#] + DSS To make it easy to leave messages for others in your office without having to dial their extension number first, keyset users may simply dial [#] plus a mailbox (extension) number and leave a message directly. If you dial a busy extension press [#] to connect directly with the mailbox.

### Self Memo (Reminder)

Pressing [##] will leave a message in your own mailbox. This is useful to remind yourself of things to do now or in the future. Messages can be sent with future delivery so you can have the system call you when items become due.

## INTERACTIVE DISPLAYS

Display keyset users have the added advantage of using the soft keys and displays to play, save, delete, reply, call, forward, rewind, pause, fast forward, change the volume, get message information, or help.

### Viewing Mailbox Contents

If you have new messages, in addition to the Telephone Status Indicator (TSI) you will be able to use the keyset displays and soft keys to communicate with the SVMi E-Series.

## E-MAIL GATEWAY (EMG)

The E-Mail Gateway feature integrates your voice mail box with your email client. No matter what email client software you are using or where you use it, you can send voice mail messages and fax mail messages to your E-Mail inbox.

There are two parts to the E-Mail Gateway; E-Message Delivery and E-Message Notification.

- 1. E-MESSAGE DELIVERY:** Voice mail messages (.wav) and/or fax mail messages (.tiff) are "delivered" to your Inbox with the appropriate attached file.
- 2. E-MESSAGE NOTIFICATION:** You will receive an e-mail, with NO attachments, notifying you that you have a voice and/or fax mail message in your Voice Mail Box.
  - As a subscriber you can use either E-Message Delivery and/or E-Message Notification.
  - As a subscriber you can have multiple e-mail addresses. (a maximum of 5 valid email addresses).
  - E-Message Notification can be set to one e-mail address while E-Message Delivery is set to different e-mail address.

## Functionality

- With either type of EMG, when Caller ID (CID) is provided, the callers telephone number will appear in the subject field of the email along with the date and time stamp of when the voice message was originally recorded in your Voice Mail Box.
- If the caller is also a subscriber on the system and the E-Mail Gateway is set up with a valid "Reply To" address, the Subscriber's name will also appear in the "From" field. Otherwise, the "From" field will display the name of the Samsung voice mail system (SVMi-8E, SVMi-16E, or SVMi-20E) sending the message.
- Client will use their PC's Multi-Media kit (equipped with either speakers and/or a headset) to listen to messages delivered to their e-mail Inbox.

**IMPORTANT NOTE:** If the PC/Laptop/PDA/Smart Phone/etc... is not equipped with hardware and software capable of playing a '.WAV' file then the E-Mail Gateway will not work for them until they add some method to listen to '.WAV' files delivered to their Inbox.

The same applies to Fax Mail messages, if the device the subscriber is using does not support the viewing of '.TIFF' files, then the E-Mail Gateway for Fax Mail will not work for them until they add some method to view .tiff files delivered to their inbox.

- No Synchronization of messages is performed between the Voice Mail Box and the E-mail Inbox.
  - Messages listened to, forwarded, deleted, and/or saved within an e-mail inbox will NOT effect the status of that same new message in the Voice Mail or the MWI (Message Waiting Indicator) associated with that message on the phone.
  - Also messages listened to in the Voice Mail, from a phone, will not change the Unread/Read status of the same message in an e-mail inbox.

- However, the Voice Mail Administrator can adjust parameters per subscriber or group of subscribers that decide how, when, or if to delete the original voice message after it is sent to the E-Mail Server.
- When full synchronization of messages between Voicemail Box and E-mail Inbox is required, ask your Samsung representative about the OfficeServ IP-UMS. This is an Internet Protocol based fully synchronized Unified Messaging System.

## Benefits

- Store and Archive Voice and Fax Mail Messages in visible folders.
- Voice and Fax Mail Messages can now easily be dragged and dropped into folders the same way e-mail messages are organized and saved.
- Voice and Fax Mail Messages are now essentially the same as any other e-mail message.
- Backups and Message Archives can be made when they are made for all other types of e-mail messages.
- Add text notes and comments to use for reference later.
- Some (if not all) e-mail clients will allow you to edit the body of the e-mail to add comments.
- Some will allow you to edit the subject field to help you find a particular message quickly in a large archive of messages.
- Call Back Numbers and Date & Time Stamp are easily displayed in the Subject field.
- Easily forward Voice messages received, to others even if they are not a Voice Mail Subscriber on your system.
- No EMG System or Client Software to load on your Local PC or Network Servers.

Therefore compatible with most:

- E-Mail providers and E-Mail Clients
- PCs, Laptops, PDA, and/or Smartphones



**NOTE:** If you are not sure you have this functionality on your system and you would like to use it, please contact your on Site system administrator to see if it is available.

## USB Port

The SMT-i5243 phone has one built-in USB v1.1 port that supports three types of external USB devices:

1. **USB BLUETOOTH DEVICES:** Users can make and receive calls through a bluetooth wireless headset when connected with the USB bluetooth dongle.
2. **USB CAMERA:** Users can make and receive video calls among SMT-i5243 phones at local or remote site (*requires MPS channels*) when connected to a USB camera.
3. **USB FLASH MEMORY:** When connected to an external USB memory stick, users can upload or download phonebook items to the phone. Administrator can also use the USB memory to upgrade the phone software.

## SETTING UP A BLUETOOTH HEADSET

- 1 Plug in a supported Bluetooth USB dongle.  
*Refer to External USB Port Specifications at the end of this section.*
- 2 To pair the Bluetooth headset to the phone, refer to the Bluetooth headset set up instruction from the manufacture and use the following instructions for the phone.
- 3 Press **Menu** soft button when the phone is in idle screen.
 
- 4 Press **Settings** soft button.
 
- 5 Press **01 Application Settings**.
 

**6** Press **Headset**. The headset option is the last selection of this menu.

Enable the following items:

1. Headset: Use
2. Headset Type: Bluetooth
3. Incoming BT Connection: Accept



**7** Press **Bluetooth Headset Setting**.



**8** Press **Connect** soft button (make sure the Bluetooth Headset is on and in the initial pairing mode).



**9** Press **Connect** again when it finds the Bluetooth headset.



**10** Press **Yes** to confirm to pair with this Bluetooth headset.



**11** Enter the **PIN** and press **OK**. The PIN is assigned by the Bluetooth headset manufacture. The default PIN is usually 0000.

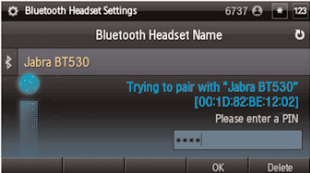

**12** After validation and registration processes are completed, the headset will display as registered.



**13** Press the **Home** icon. The Bluetooth icons should appear in the main idle screen. The Bluetooth headset is now ready to be used.



## SETTING UP A VIDEO CAMERA

**1** Plug in a supported video camera into the USB port.  
*Refer to External USB Port Specifications at the end of this section.*

**2** With a phone in idle screen, press **Menu**, **Settings**, **Application Setting**, and then **Video Call**.



**3** Enable the following items:

- a. Call Mode: Video
- b. Camera: ON

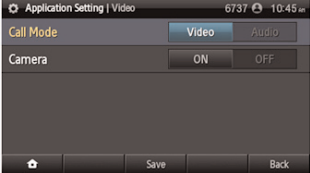

**4** The main idle screen will show the Video Mode icon and **CallMode** soft button will appear. The video camera is ready to use. User can disable or enable the video mode by pressing the **CallMode** soft button.



## FLASH USB MEMORY STICK

USB memory stick can be used to copy personal phonebook items or to upgrade the phone software. Instruction on software upgrade is available to administrator only. User should not attempt to upgrade the software.

To copy phonebook items follow the instructions below.

1 Plug the supported USB memory stick into the USB port.

2 When phone is in idle screen, press **Menu**, **Settings**, and then **User Data Management**.

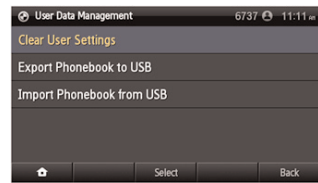

3 Use **Export Phonebook to USB** to save your personal phonebook stored in the SMT-i5243 phone into the USB memory, and **Import Phonebook from USB** to upload the phonebook stored in the USB to your SMT-i5243 personal phonebook.



## EXTERNAL USB PORT SPECIFICATIONS

The SMT-i5243 phone has one built-in USB v1.1 port that supports three types of external USB devices (USB port does not support USB hub):

1. **USB BLUETOOTH DEVICES:** Users can make and receive calls through a bluetooth wireless headset when connected with the USB bluetooth dongle.

### USB Bluetooth Dongle

Most of USB Bluetooth dongle that contains CSR (Cambridge Silicon Radio) chipsets will work with the phone. There is no way to verify all the products in the market. The following products have been verified with the phones:

- Billionton USB Bluetooth Adapter (v2.1 + EDR)
- Belkin Mini Bluetooth Adapter
- Billionton BT0003
- Inparo H-20
- Collection SS-BT2
- Hama Nano-Bluetooth USB Bluetooth Adapter v2.1 + EDR

### Bluetooth Headset:

- Jabra BT530
- Aliph Jawbone II Bluetooth Headset with NoiseAssassin
- Samsung WEP 250
- Plantronics Voyager 925
- Plantronics Voyager pro
- Plantronics Discovery 925

2. **USB CAMERA:** Users can make and receive video calls among SMT-i5243 phones at local or remote site (required MPS channels) when connected to a USB camera.

Most of the USB camera with UVC (USB video class) driver should not have issue with the phone. There is no way to verify all the products in the market. The following products have been verified with the phones:

- Logitech QuickCam Pro 9000
- Logitech QuickCam Deluxe
- Logitech Webcam C250
- Logitech Webcam C300
- Microsoft LifeCam VX-800

3. **USB FLASH MEMORY:** When connected to an external USB memory stick, users can upload or download phone book items to the phone. Administrator can also use the USB memory to upgrade the phone software.

Any USB memory sticks that support Linux operation system should not have any issue with the phone. Most of recent USB memory sticks can support both Windows and Linux operating systems. The phone support USB memory sticks with maximum size of 4 GB.

The following products have been verified with the phones:

- Kingston DataTraveler I 2GB
- Kingston DataTraveler I 4GB

## PERSONAL SPEED DIAL NUMBERS

CODE	NAME	TELEPHONE NUMBER
00	_____	_____
01	_____	_____
02	_____	_____
03	_____	_____
04	_____	_____
05	_____	_____
06	_____	_____
07	_____	_____
08	_____	_____
09	_____	_____
10	_____	_____
11	_____	_____
12	_____	_____
13	_____	_____
14	_____	_____
15	_____	_____
16	_____	_____
17	_____	_____
18	_____	_____
19	_____	_____
20	_____	_____
21	_____	_____
22	_____	_____
23	_____	_____
24	_____	_____

## PERSONAL SPEED DIAL NUMBERS

CODE	NAME	TELEPHONE NUMBER
25	_____	_____
26	_____	_____
27	_____	_____
28	_____	_____
29	_____	_____
30	_____	_____
31	_____	_____
32	_____	_____
33	_____	_____
34	_____	_____
35	_____	_____
36	_____	_____
37	_____	_____
38	_____	_____
39	_____	_____
40	_____	_____
41	_____	_____
42	_____	_____
43	_____	_____
44	_____	_____
45	_____	_____
46	_____	_____
47	_____	_____
48	_____	_____
49	_____	_____

## FEATURES AND SPECIFICATIONS

### LINE GROUPS

9 Local/LCR  
 800 \_\_\_\_\_  
 801 \_\_\_\_\_  
 802 \_\_\_\_\_

### STATION GROUPS

501 \_\_\_\_\_  
 502 \_\_\_\_\_  
 503 \_\_\_\_\_  
 504 \_\_\_\_\_

### PAGING ZONES - DIAL 55 PLUS

0 \_\_\_\_\_  
 1 \_\_\_\_\_  
 2 \_\_\_\_\_  
 3 \_\_\_\_\_  
 4 \_\_\_\_\_  
 5 \_\_\_\_\_  
 6 \_\_\_\_\_  
 7 \_\_\_\_\_  
 8 \_\_\_\_\_  
 9 All External Zones  
 \*All External Zones and Internal Zone 0

### PROGRAMMED MESSAGES

01 In A Meeting  
 02 Out On a Call  
 03 Out To Lunch  
 04 Leave A Message  
 05 Page Me  
 06 Out Of Town  
 07 In Tomorrow  
 08 Return Afternoon  
 09 On Vacation  
 10 Gone Home  
 11 \_\_\_\_\_  
 12 \_\_\_\_\_  
 13 \_\_\_\_\_  
 14 \_\_\_\_\_  
 15 \_\_\_\_\_  
 16 \_\_\_\_\_  
 17 \_\_\_\_\_  
 18 \_\_\_\_\_  
 19 \_\_\_\_\_  
 20 \_\_\_\_\_

### FEATURE ACCESS CODES

10 + xxx	Pick Up A Parked Call
12 + xxx	Pick Up A Held Call
13	Door Lock Release
16 + xxx	Speed Dialing
17	Save And Redial Number
18	New Call (Recall)
19	Last Number Redial
400	Cancel Do Not Disturb
401	Set Do Not Disturb
42 + xxx	Cancel Message You Left
43	Return Message
44	Callback
45	Busy Station Camp-On
46	Conference
47	Account Code
48 + xx	Cancel Programmed MSG
49	Send Flash To C.O. or PBX
56	Meet Me Answer
600	Cancel All Call Forward
601 + xxx	Set Forward All Calls
602 + xxx	Set Forward Busy
603 + xxx	Set Forward No Answer
604 + xxx	Set Fwd Busy/No Answer
605 + xxx	Set Forward on DND
606 + xxx	Set Forward Follow Me
65 + xxx	Pick Up Ringing Extension
66 + xx	Pick Up Group
67	Universal Answer
*	Authorization Code



# OfficeServ™

## SMT-i5230



USER GUIDE



# OfficeServ™ SMT-i5230

## Keyset User Guide

*For OfficeServ™ 7000 Series Systems*

# TABLE OF CONTENTS

<b><u>ABOUT THIS BOOK</u></b> .....	1
<b><u>SECTION 1. CAUTION AND PREPARATION</u></b> .....	2
<b><u>CAUTION</u></b> .....	3
<b><u>PREPARATION</u></b> .....	4
Check the Contents of the Box .....	4
Phone Installation .....	4-5
Optional Equipment.....	5-6
<b><u>SECTION 2. PHONE FUNCTIONS</u></b> .....	7
<b><u>SMT-i5230 LAYOUT</u></b> .....	8
Names and Functions .....	8
<b><u>KEY FUNCTIONS</u></b> .....	10
Telephone Status Indicator .....	10
Screen Structure .....	10
Text Input Method .....	11
Description of Icons .....	12
Navigating the Menus.....	13
Navigation Button and Selector Switch for FWD/DND/ABSENT MSG ....	13
<b><u>SMT-i5230 SETUP</u></b> .....	14
Initializing the SMT-i5230 .....	14
Setup Mode .....	14
Easy Install Wizard .....	15
Selecting the Static IP Option .....	15
Setting Up Hot Desking (Idle Login) .....	15-16
Configuration Menu Structure.....	16
<b><u>SECTION 3. FREQUENTLY USED</u></b> .....	
<b><u>FEATURE OPERATION</u></b> .....	17
<b><u>EXTENSION LOG IN &amp; OUT</u></b> .....	18
<b><u>PLACING CALLS</u></b> .....	18
<b><u>ANSWERING CALLS</u></b> .....	19
<b><u>PLACING A CALL ON HOLD</u></b> .....	20
<b><u>TRANSFERRING CALLS</u></b> .....	20

Copyright 2010 Samsung Telecommunications America.

All rights reserved. No part of this manual may be reproduced in any form or by any means—graphic, electronic or mechanical, including recording, taping, photocopying or information retrieval systems—without express written permission of the publisher of this material.

Samsung Telecommunications America reserves the right without prior notice to revise information in this guide for any reason. Samsung Telecommunications America also reserves the right without prior notice to make changes in design or components of equipment as engineering and manufacturing may warrant. Samsung Telecommunications America disclaims all liabilities for damages arising from the erroneous interpretation or use of information presented in this guide.



<b>TRANSFERRING WITH CAMP-ON</b> .....	21
<b>CALL WAITING</b> .....	21
<b>CONFERENCE CALLS</b> .....	21
<b>FORWARDING CALLS</b> .....	22
<b>OTHER FEATURES AND FUNCTIONS</b> .....	22-25
<b>SECTION 4. PHONE FEATURES</b> .....	26
<b>BASIC MENUS</b> .....	27
Soft Button Structure .....	27
Menu Soft Button .....	27-37
Func. Soft Button .....	37
AOM Soft Button .....	37
<b>SECTION 5. OFFICESERV 7000 SYSTEM FEATURES</b> .....	38
<b>OUTSIDE CALLS</b> .....	39
Making Calls from AOM .....	39
Universal Answer .....	39
Recall Dial Tone .....	39
Sending a Flash .....	39
Busy Line Queuing with Callback .....	39
Busy Station Callback .....	40
Canceling Callback .....	40
Busy Station Camp-On .....	40
<b>INTERCOM CALLS</b> .....	42
Voice Announce Mode .....	42
Auto Answer Mode .....	42
Calling your System Operator .....	42
<b>CALL PROCESSING</b> .....	43
System Hold .....	43
Exclusive Hold .....	43
Remote Hold .....	43
Hold Recall .....	44
Consultation Hold .....	44
Retrieving Calls Held at Another Station .....	44
Call Transfer .....	45
Transfer with Camp-On .....	45
Transfer to Voice Mail .....	46
Call Waiting .....	46
Call Forward Options .....	46
Station Call Pickup .....	47

Group Call Pickup .....	47
My Group Pickup .....	48
Privacy Release .....	48
<b>DIALING FEATURES</b> .....	49
Speed Dialing .....	49
Programming Personal Speed Dial Numbers .....	49
Directory Dialing .....	50
Last Number Redial .....	51
Save Number with Redial .....	51
Automatic Redial/Retry .....	51
Pulse to Tone Changeover .....	51
<b>PAGING AND MESSAGING</b> .....	52
Making and Internal Page .....	52
Making an External Page .....	52
All Page .....	52
Meet Me Page .....	53
Call Park and Page .....	53-54
Messages—Set and Cancel .....	54
Returning Messages .....	55
Programmed Messages .....	55
<b>CONVENIENCE FEATURES</b> .....	56
Logging In and Out .....	56
Do Not Disturb .....	56
One Time DND .....	56
Mute .....	57
Background Music .....	57
Established Call Pick-Up .....	57
Door Phone Calls .....	57-58
Executive/Secretary .....	58
Group Listening .....	59
Account Codes .....	59
Locking Your Keyset .....	60
Manual Signalling .....	60
Off-Hook Voice Announce .....	61
OHVA Block .....	61
OHVA Reject .....	61
In Group/Out of Group .....	62
<b>CUSTOMIZING YOUR KEYSSET</b> .....	63
AME Password .....	63
Auto Camp-On .....	63
Select Ring Tone .....	63
Change Your Passcode .....	63

Set Answer Mode (Intercom) .....	64
Set Answer Mode (CO) .....	64
Automatic Hold .....	64
Headset Operation .....	64
Hot Keypad .....	65
Key Confirmation Tone .....	65
Rejoining a Page .....	65
Ring Preference .....	66
Display Speed Dial Name .....	66
Caller ID Review All .....	66
Secure OHVA .....	66
Configure Mobile Extensions (MOBEX) .....	66-67

Message Broadcast .....	89
Personal Services .....	89
Personal Administration Settings .....	90
Keypad User Features .....	91
Shortcuts .....	93
Interactive Displays .....	93
E-Mail Gateway (EMG) .....	93-95

**PERSONAL SPEED DIAL NUMBERS.....96-97**

**DISPLAY FEATURES .....**68

Directory Information .....	68
Display Number Dialed .....	68
Call Duration Timer .....	68
Auto Timer .....	68
Timer Function .....	69
Viewing Station Message Indications .....	69
Personal Speed Dial Names .....	69
Station Names .....	69
Managing Programmable Key Assignments .....	70
Backspace with LCR .....	70

**CALLER ID.....**71

Selecting Your Caller ID Display .....	71
Viewing the Next Caller ID Call .....	72
Inquire Caller ID Park/Hold Info .....	72

**FEATURE ACCESS CODES .....**73

**SECTION 6. APPLICATIONS .....**74

**SAMSUNG VOICEMAIL .....**75

SVMi E-Series Subscriber Services Menu Diagram .....	76-77
Accessing Your Mailbox .....	78
Getting Started .....	79
Listen to your Messages .....	79
Subscriber Services Menu .....	79
Listening to Old or New Messages .....	80
Group New or Old Messages .....	81
Record and Send a Message .....	81
Access Manager .....	83
Personal Greetings .....	84
Mailbox Administration .....	87

## ABOUT THIS BOOK

The new Samsung Multimedia Telephone SMT-i5230 keyset is part of the OfficeServ 7000 Series.

The SMT-i5230 keyset represents a new concept of Internet phone, in that it uses an IP address to Send/Receive voice and data. For voice communications, the SMT-i5230 uses the data network line already in place in most offices and increasing number of homes.

This guide contains 6 sections: Section 1. Caution and Preparation, Section 2. Phone Functions, Section 3. Frequently Used Feature Operation, Section 4. Phone Features, 5. OfficeServ 7000 System Features, and Section 6. Applications. Please take the time to study this guide and to become familiar with the operation of your keyset. Keep this guide handy, as you may need to look up instructions for infrequently used features.

This book is written based on factory default settings, for the feature access codes. Sometimes, due to programming requirements, these codes may be changed. If you find that a feature code does not work as described in this book, please contact your installation and service company to determine the correct code.

## CAUTION

# SECTION 1. CAUTION AND PREPARATION

- Read the installation instructions before connecting the system to its power source.
- If there is dirt or moisture on the pin contact surface of a power plug, pull out the plug and wipe it away with a cloth. If dirt or moisture remains on the product even after wiping, contact the service center.
- For the power connection port of the phone, use the supplied power adapter. (The power adapter is supplied separately.) Use of a power adapter that does not meet the specifications may cause the product to become damaged, to overheat, or to explode.
- Do not place the phone in a location with a lot of dust, in a location that is subject to severe changes in temperature, or near a heating device (cigarette heat, heater, etc.)
- Do not use or store flammable spray or materials near the phone.
- Do not place vases, flowerpots, cups, or a container of cosmetics or drugs near the phone.
- Installation of equipment must not route interconnecting cables or external power supply sources outdoors.
- The LAN cable to the network should be connected to the LAN port of a phone, NOT to the PC connection port.
- Use a soft and dry cloth when cleaning the phone. Do not spray water directly onto the product; and do not use chemicals such as wax, benzene, alcohol, thinner, mosquito killer, perfume spray, lubricant, detergent, etc.

# PREPARATION

## CHECK THE CONTENTS OF THE BOX

Check if the product package box includes all the components as follows:

- Phone body including a base
- Handset
- Handset cord
- Patch cable

**NOTE:** Power transformer sold separately. If any of these items are missing or damaged, please contact your dealer.

## PHONE INSTALLATION

### Connecting the Phone Body

- 1 Remove the base of the phone by pressing the **[Push]** mark on the top of the base.

Note: The base can be used to adjust the phone angle in the high or low position.

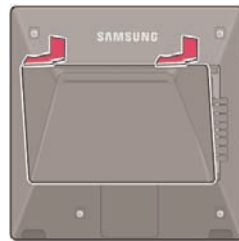

- 2 Connect a handset to the handset port of the phone. (See handset icon)

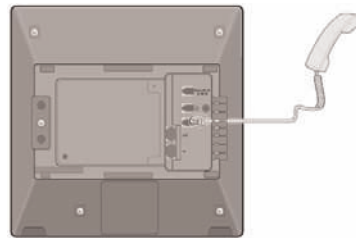

- 3 OPTIONAL: Connect the cable through the middle hole of the cradle to the PC, as shown in the figure. When connecting to PC, connect one end of the cable to the PC port of the phone, and the other end of the cable to the LAN port of the PC.

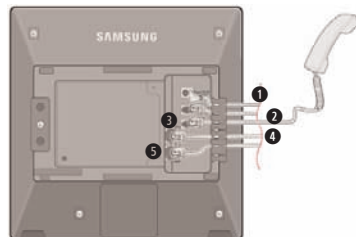

① AC Power (5VDC) ② Headset ③ Handset Cord ④ LAN to Phone System ⑤ Phone to PC

Connect the LAN cable to the LAN port of the phone, as shown in the figure.

When power is supplied from the LAN port (PoE), the phone is booted upon LAN connection.

If PoE is not supported, connect the power adapter to the **power port** of the phone. If the connected power adapter is plugged into an outlet, the phone is booted. (The power adapter is supplied separately.)

- 4 Fix the base to the phone body by fitting the bottom groove and then securing the top side.

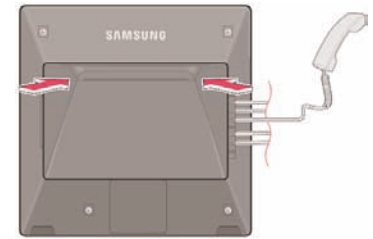

- 5 Secure the cable along the cable guideline as shown in the figure. For the cable of power adaptor, give some slack before securing the cable to the guideline to prevent easy disconnect.

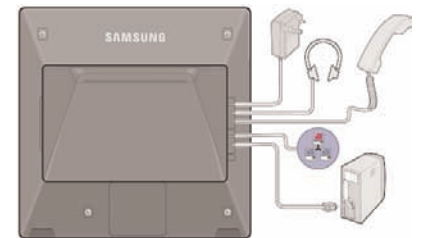

## OPTIONAL EQUIPMENT

### SMT-i5264 [ADD-ON MODULE]

The **SMT-i5264** IP AOM can be registered and programmed to function with any ITP 5100 keysets, SMT-i Series, and TDM phones. This add-on module was cosmetically designed to match the SMT-i5000 Series phones. In some applications multiple IP AOMs can be supported per IP phone. *For installation instructions, see your System Administrator.*



### **SMT-A52GE [GIGABIT ADAPTER]**

The **SMT-A52GE** Gigabit Adapter processes the Gigabit data for a Gigabit LAN connection on the PC connected to the SMT-i5200 Series IP phones. The SMT-A52GE can be installed to function with any of the SMT-i5200 Series IP phones. *For installation instructions, see your System Administrator.*



### **WALL MOUNT BRACKET**

An optional bracket is available for wall mounting the SMT-i5200 Series phones to the wall. *For installation instructions, see your System Administrator.*

### **SMT-A53PW [POWER ADAPTER]**

The power adapter is sold separately.

#### **CAUTION**

The input power of the SMT-i5230 needs 5.0vDC and 3000mA. The SMT-i5230 phone needs to be powered by using Samsung's SMT-A53PW power adapter. Failure to use the appropriate power supply will cause permanent damage to the phone and will void Samsung's warranty.

## **SECTION 2. PHONE FUNCTIONS**

# SMT-i5230 LAYOUT

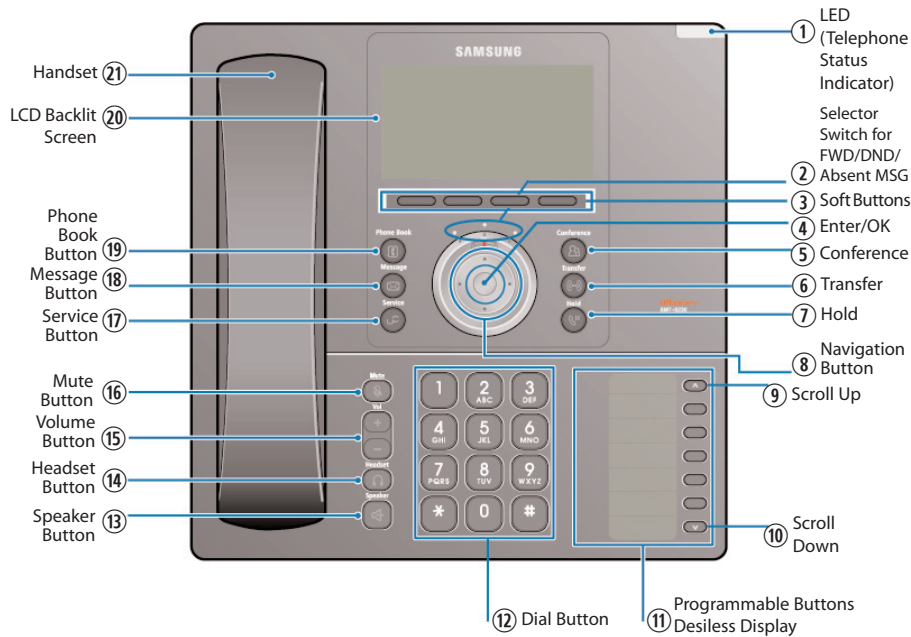

**NOTE:** The words “key” and “button” are interchangeable.

## NAMES AND FUNCTIONS

Button	Function
① LED (TSI)	The blinking pattern differs depending on the phone status (Telephone Status Indicator).
② Selector Switch for FWD/DND	Used to select or deselect the <b>Call Forwarding/DND/Absent Message</b> setting by using the Selector Switch control.
③ Soft Buttons	Used to select the desired function from the soft menus displayed at the bottom of the LCD screen.
④ Enter/OK	Used to make selection or to save an entry.
⑤ Conference Button	Used for conference calls.
⑥ Transfer Button	Used to enable the call transfer function.
⑦ Hold Button	Used to place a call on hold.
⑧ Navigation Button	Used to move the display cursor up and down, left and right on certain menus.

Button	Function
⑨ Scroll Up Button	Move up through 20 pages of AOM (99 total).
⑩ Scroll Down Button	Move down through 20 pages of AOM (99 total).
⑪ Programmable Buttons	5 desiless buttons used to set up and label function buttons on the phone.
⑫ Dial Button	Used to dial the phone number.
⑬ Speaker Button	Used to enable/disable the use of a speaker phone.
⑭ Headset Button	Used to activate and deactivate the headset jack.
⑮ Volume Button	Used to control the volume settings.
⑭ Mute Button	Used to silence the transmit voice to the remote party.
⑮ Service Button	For use with the Unified Communicator Server (optional)
⑯ Message Button	Used to access all the messaging options: Voicemail Messages, Station Messages, SMS, and E-Mail Messages.
⑰ Phone Book Button	Used to search for a phone number saved in the phone, or to register a new number. Pressing this button shows the main screen of the phone book. Used to move downward on various list screens.
⑱ LCD Screen	A backlit display showing the phone’s status (busy, ringing, receiving an internal message, etc.)
⑲ Handset	Used for two-way voice conversation.

# KEY FUNCTIONS

**NETWORK:** The SMT-i5230 uses VoIP communication through an already-installed data network.

**LCD SCREEN:** Various functions are displayed on the LCD screen, so you can use them conveniently by using the **Navigation** buttons on the phone.

**SHORT MESSAGE SERVICE (SMS):** You can exchange text messages using this function. This function is available on internal IP stations.

## TELEPHONE STATUS INDICATOR

The indicators are turned on or off depending on the status of relevant functions.

Screen	Status	LED Indicator
	When station is busy	Red colored indicator is constant.
	When station is receiving an incoming call	Red indicator (slow flash).
	When there is a message	Red indicator (slow flash).
	During "Do Not Disturb"	Red indicator (fast flash).
	Incoming Trunk Call	Green colored indicator flashes.
	Hold Recalls	Amber colored indicator flashes.

## SCREEN STRUCTURE

The screen consists of three areas.

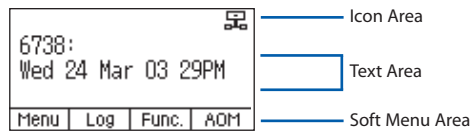

Area	Description
Icon Area	Displays various icons.
Text Area	Displays date, time, extension number, name, message, phone number, etc.
Soft Menu Area	Displays the functions allocated to the 4 soft buttons. Service menus are provided depending on the state of the phone. A user can use the service or feature menus by pressing the soft button.

## TEXT INPUT METHOD

Using the dial and direction buttons on the phone, you can enter and modify the English characters, numeric and special characters.

Whenever you press the dial button **[\*]** on a text input screen, the input mode is changed in sequence.

### Text Input Example

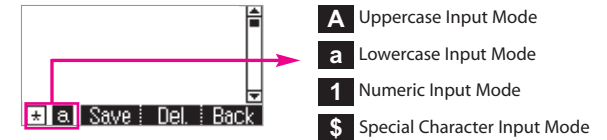

- Use the dial buttons to type English text and numbers; and use the **Navigation Button** to move the cursor left and right and **OK** buttons to complete input. When removing the typed characters, select the **Del** soft button.

**Alpha Characters Input:** Select this mode (uppercase/lowercase) by pressing the **[\*]** button, and type text by repeated pressing the dial buttons, characters will auto advance after a time limit.

**Number Input:** Select this mode by pressing the **[\*]** button on keypad, move the cursor highlighted to 1, then use the keypad to enter digits.

**Special Character Input:** Select this mode by pressing the **[\*]** button on keypad; select a desired character by using the **Navigation Button**; and press the **OK** button to enter it.

### Keypad Character Entry

Count	1	2	3	4
<b>Dial *</b>	A (Uppercase)	a (Lowercase)	1 (Numbers)	\$ (Special Characters)
<b>Dial #</b>	Not Used			
<b>Dial 0</b>	Not Used			
<b>Dial 1</b>	Not Used			
<b>Dial 2</b>	A	B	C	
<b>Dial 3</b>	D	E	F	
<b>Dial 4</b>	G	H	I	
<b>Dial 5</b>	J	K	L	
<b>Dial 6</b>	M	N	O	
<b>Dial 7</b>	P	Q	R	S
<b>Dial 8</b>	T	U	V	
<b>Dial 9</b>	W	X	Y	Z



## DESCRIPTION OF ICONS

The following icons are displayed on the screen.

Icon	Description
	Shows that 'Call Forward' is enabled.
	Shows that 'Do Not Disturb' is enabled.
	Shows that 'Mute' function is enabled. When the call ends to become a standby status or this function is disabled, this icon disappears.
	Shows that the call is <b>hold</b> state. When call is reconnect or disconnected, this icon disappears.
	Appears when there are unread <b>Short Messages</b> in the message inbox. Once they are read, it disappears.
	Shows that a LAN cable is <b>connected</b> to the <b>PC port</b> .
	Shows that a <b>LAN cable</b> is connected to the LAN port but that the system is <b>not connected</b> .
	Shows that a <b>LAN cable</b> is <b>connected</b> to the LAN port and that the system is connected normally.
	<b>Outgoing</b> Call icon.
	<b>Incoming</b> Call icon.
	<b>Missed</b> Call icon.
	Appears when the <b>Speaker</b> button is active.
	Appears when the <b>Headset</b> button is active.
	Shows when there is a <b>Cell phone</b> number for the entry in the Phone Book.
	Shows when there is a <b>Home phone</b> number for the entry in the Phone Book.
	Shows when there is a <b>Office phone</b> number for the entry in the Phone Book.
	Shows when there is an internal <b>Extension</b> number for the entry in the Phone Book.

## NAVIGATING THE MENUS

When programming within various menu options, information can be entered via the dial pad keys using [0]-[9] and [\*] dial keys. The button used for editing and their features are summarized below.

BUTTONS	FEATURES
<b>Volume + and -</b>	To move the cursor left and right, up and down.
<b>Hold</b>	To clear/delete an entire field such as station name.
<b>Transfer</b>	To write the changes and exit programming.

## NAVIGATION BUTTON and SELECTOR SWITCH FOR FWD/DND/ABSENT MSG

The SMT-i5230 phone has a navigation button and a Selector Switch for FWD/DND to allow users to use its functions easily.

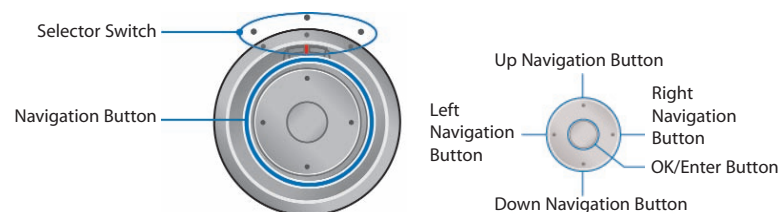

The Selector Switch can be used to manually set and cancel station Call Forwarding and Do Not Disturb. **NOTE: Do not use the access codes or the function menu to cancel FWD/DND when the selector switch is set in the left or right position because the switch takes precedence over the access codes/function menu.**

BUTTON	FUNCTION	
<b>Selector Switch</b>	Left	Users can set the phone to the call forward state.
	Center	The default standby status. (Normal Mode)
	Right	This is set to "Do Not Disturb" and absent message status.
<b>Navigation</b>	Direction Key	Users can edit the contents on the screen or move between menu items.
	OK/Enter	Users can select or save the item where a cursor is placed in a menu mode. Users can check the caller information received from a station line during receiving.

# SMT-i5230 SETUP

## INITIALIZING THE SMT-i5230

Initially the SMT-i5230 IP keyset will need to be setup to operate within the users network. The Setup Menu is also used to make changes to the keyset, in the event that the system information should change. The option chosen will be highlighted.

The station numbers will be automatically set by the OfficeServ 7000 Series systems once the necessary information has been entered into the IP keyset. Enter ID and password of the server, as described below to register the phone.

See your system administrator for specific Network and Server addresses. The addresses necessary to set up the SMT-i5230 are:

- IP Address of Station
- Network Gateway Address
- IP Address of System's main processor
- User ID
- Password

## SETUP MODE

To get to the **Setup Mode** unplug the power cord from the SMT-i5230. Press and hold the **\*** button while you plug power back into the phone. Release the **\*** button when you see Samsung in the display. If you have a PoE (Power over Ethernet) connection, the same procedure can be done by unplugging and plugging the Ethernet cable into the phone while pressing and holding the **\*** button.

When the phone reboot is complete, the **Language Menu** will display. Press the **Yes** soft button to advance to the **Configuration Menu**.

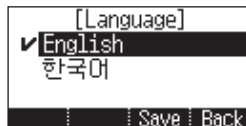

Once the **Configuration Menu** is displayed, you can move to each menu in the Setup by using the navigation button and **[1]-[8]** dial buttons of the SMT-i5230 IP phone. [To learn how to navigate the menus refer to the previous section.](#)

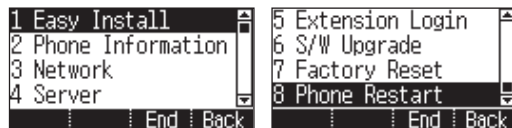

## EASY INSTALL WIZARD

By selecting this option, the System Easy Wizard can guide you through setting up your network parameters. If you want to set up these parameters individually, follow the instructions below.

- From the idle phone press **Menu**, scroll to **Phone**, and press **OK** button. Scroll to **Phone Information** and press **OK** button. From the keypad, enter the administrator's password (please contact your phone system administrator). Scroll to **Easy Install** and press **OK** button.

## SELECTING THE STATIC IP OPTION

- When the Static IP option is selected, enter the System Type OSSP (KP), and press **OK**.
- Enter the **Static IP Address** for the phone (eg. 192.168.9.193) then press the **OK** button.
- Enter the **Subnet Mask** (eg. 255.255.255.0); press **OK** button.
- Enter **Gateway Address** (eg. 192.168.9.1), press **OK** button.  
**NOTE:** Press the **\*** key on the dial pad to enter the "." in the IP address.
- Skip [VLAN-PHONE], [VLAN-PC], [802.1x Setting] by pressing the **OK** button three times.
- Enter the **System IP address** (eg. 192.168.9.200), press **OK** button.
- Enter **System ID** XXXX (eg. 3201), then press **OK** button.
- Enter **Password** XXXX (eg. 1234) then press **OK** button.

Wait a second for the phone to reboot. The phone should register and authenticate itself to the phone system. Test SMT-i5230 for proper operation.

## SETTING UP HOT DESKING [IDLE LOGIN]

Hot Desking allows you to log in and out of your SMT-i5230 IP keyset without rebooting.

- Press the **Menu** soft button, scroll to **Phone** then press **OK** button.
- Scroll to **Phone Information** and press **OK** button.
- Enter the administrator's password (please contact your phone system administrator).
- Scroll to **Extension Login** then press **OK** button.
- Choose the **ON** option and press **OK** button. (Note: **ON** to allow, **OFF** to deny hot desking).
- Press the **Save** soft button to complete the setup.
- When the phone restarts, enter the **ID** (eg; extension 2809) and **password**.
- Press the **Save** soft button to complete the login.

# CONFIGURATION MENU STRUCTURE

This menu is for administrator use and required a password. The **Configuration Menu** options are as follows:

## 1. EASY INSTALL

This option will guide you through setting up all required parameters for connecting the SMT keyset to your system.

## 2. PHONE INFORMATION

1. Version Info: Provides boot rom, software, DSP, and hardware version information.
2. Network Info: Displays network mode, IP address of phone, network, and gateway information.
3. MAC Address

## 3. NETWORK

Displays Static IP, Dynamic IP, PPPoE, NAT, 802.1x, VLAN (LAN), and VLAN (PC).

## 4. SERVER

1. Primary System: The main processor's IP address.
2. System 1~3: Up to 4 server IPs can be set.

## 5. EXT. LOGIN

Allows the user to choose the option of permitting the phone either login/logout from idle mode or only register to the server on power up. Once the phone is placed into Extension Login mode, a display will show up to allow you to enter any valid User ID and password. This function is also referred to as hot desking (idle login).

## 6. S/W UPGRADE

1. TFTP Server: The IP address of the TFTP server containing the IP software.
2. Upgrade: Starts the IP software upgrade process.

## 7. FACTORY RESET

This option resets the SMT-i5230 to factory default settings.

## 8. PHONE RESTART

This option reboots the SMT-i5230 phone.

# SECTION 3. FREQUENTLY USED FEATURE OPERATION

This section provides the basic operation of your Samsung Multimedia Telephone **SMT-i5230**.

## EXTENSION LOG IN & OUT [HOT DESKING]

If enabled, your SMT-i5230 telephone may require you to log in before making or receiving calls. In these cases your telephone system administrator will provide you with an extension number, password, and the feature code used to log out.

### TO LOG IN

- Dial your extension number in the ID field (example 3201).
- Press the **OK** button.
- Dial your password in the password field (example 1234).
- Press **Save** soft button.



### TO LOG OUT

- Dial the feature code provided by your administrator (for example 77).

## PLACING CALLS

**IMPORTANT:** Put your phone in **Overlap Mode** by pressing the **Menu** button, select **Settings** and then select **Application Set.**, press **OK**, select **Call**, press **OK**, scroll to **Dial Mode**, change it to **Overlap** by using the Navigation Button. If your phone is not in Overlap mode you must always press the **Call** soft button after dialing the digits to send the call.

**NOTE:** All examples of making phone calls are based on the phone being set for overlap dialing mode.

**OUTSIDE CALLS** - To place a call to an outside party:

- Lift the handset.
- Press an idle outside line button, line group button, or dial a line access code to receive dial tone.
- Dial the telephone number.
- Hang up the handset when the call is completed.

**NOTE:** Frequently called telephone numbers can be added to the PhoneBook.

When making internal and external calls from AOM (programmable buttons) list, press the **AOM** soft button to access the programmable button screens. Then use the **Navigation** button to scroll to and highlight the desired programmable button. Press **OK** to complete the call.

**INTERNAL CALLS** - To place a call to another extension at your location:

- Lift the handset.
- Dial the extension number or group number.
- Wait for the party to answer. If you hear a brief tone burst instead of ringback tone, the station called is set for Voice Announce or Auto Answer. Begin speaking after the tone.
- Hang up the handset when the call is completed.

### NOTES:

1. If you have a **DSS** button assigned to an extension or station group, you may press this button instead of dialing the number.
2. If the Hot Keypad feature has been turned off, you must first lift the handset or press the **Speaker** button before you begin dialing.

**SPEAKERPHONE CALLS** - Your Samsung SMT-i5230 has full-duplex speakerphone capability. This feature is used for both internal or external calls. To activate this feature:

- Press the **Speaker** button.
- Place an internal or external call.
- Press **Speaker** button to disconnect the call.

**NOTE:** The handset can be used at any time during the conversation. To resume handsfree operation, press the **Speaker** button, and hang up the handset.

**HEADSET CALLS** - If a headset is connected to the phone, you need to press the headset key to direct the call to the headset. The headset key will be lit. To use the headset:

- Press the **Speaker** button.
- Place an internal or external call.
- Press **Speaker** button to disconnect the call.

### NOTES:

1. If you need to switch between the headset and the handset during the call, you need to place the call on hold first.
2. Headset key can be enabled or disabled in the Menu, Settings, Application Setting, Headset.

## ANSWERING CALLS

**OUTSIDE/INTERNAL/VOICE ANNOUNCE CALLS** - To answer these three types of calls:

- Lift the handset or press the **Speaker** button to answer on **Speakerphone**.
- Hang up the handset when the call is completed.

**NOTE:** The volume can be adjusted at any time by pressing the up and down buttons on your navigation button.

## PLACING A CALL ON HOLD

Calls can be placed on **System Hold** or **Exclusive Hold**. A call placed on System Hold can be picked up from any extension. Calls placed on Exclusive Hold can only be picked up from the extension that placed them on hold.

**SYSTEM HOLD** - To place a call on hold:

- Press the **Hold** button. The **Call** button will flash green at your telephone.
- To take the caller off hold, press that button and the red flashing light will go steady red again.
- Resume conversation.

**EXCLUSIVE HOLD** - To place a call on hold at your telephone so that other users cannot answer it:

- Press the **Hold** button twice. The call button will flash green at your telephone.
- To retrieve the call, press the flashing red line button or press the line button a third time.

**NOTE:** Internal calls are always placed on exclusive hold.

## TRANSFERRING CALLS

You can transfer a call by notifying the party to which the call is being transferred or without notification.

- While on a call, press the **Transfer** button then dial an extension number.
- Confirm you hear a ringback tone.
- Wait for the called party to answer and announce the call (optional).
- Replace the handset.

## TRANSFERRING WITH CAMP-ON

When you transfer a call to another station and receive a busy signal, you can camp the call on to this station. Hang up when you hear the busy signal. The called party is alerted that a call is waiting.

- Call another internal station.
- When receiving a busy tone, press the **Func.** soft button.
- Scroll to **Camp On** and press **OK** button (here ringback tone). Wait for party to answer the call.

**NOTE:** If you receive No More Calls tone, that station has no button available to receive another call. Press **Transfer** to return to the caller.

## CALL WAITING

If an outside call is camped-on to your phone or another station is camped-on to you:

- Your keyset rings and the call that is waiting (camped-on) flashes red.
- Press the flashing button to answer; the other call is put on hold automatically if your station has the Automatic Hold feature set. If not, you must press **Hold** and then the flashing button or finish the first call and hang up; the waiting call will ring.
- Lift the handset or press the **Speaker** button to answer.

**NOTE:** Intercom calls will not go on Automatic Hold.

## CONFERENCE CALLS

To make a conference call while engaged in a conversation:

- Press the **Conference** button and receive conference tone.
- Make another call, either intercom or outside, press the **Conference** button and receive conference tone.
- Make another call or press the **Conference** button to join all parties. You can conference up to five parties (you and four others).
- Repeat the last step until all parties are added.
- Hang up to leave the conference call.

**NOTE:** When attempting to add another party to the conference and you are not able to reach the desired person, hang up. Simply press the **Conference** button again to return to the previous conversation.

**To drop a party from your conference call:**

- Press the **Conference** button and dial the extension or line number that is to be dropped.
- Press the **Conference** button again to reestablish the conference.

## FORWARDING CALLS Icon

You can forward your calls to another station, group of stations, or an external telephone number. Program a destination for the type of forwarding you want by moving the **Selector Switch** to the **left** and set the **forwarding number for All, Busy, No Answer, and Busy/No Answer.**

## OTHER FEATURES AND FUNCTIONS

**VOLUME CONTROL - Vol** button is used to adjust the volume of a handset, speaker and ringing sound.

### Volume Control of a Handset

- Adjusts the handset volume while busy (handset offhook).
- To increase the volume of a handset, press the top side [+] of the **Vol** button.
- To decrease the volume of a handset, press the bottom side [-] of the **Vol** button.

### Volume Control of a Speaker

- Adjusts the speaker volume while busy (handsfree).
- To increase the volume of a speaker, press the top side [+] of the **Vol** button.
- To decrease the volume of a handset, press the bottom side [-] of the **Vol** button.

### Volume Control of a Ringing Tone

- To increase the volume of a speaker, press the top side [+] of the **Vol** button while ringing.
- To decrease the volume of a handset, press the bottom side [-] of the **Vol** button while ringing.

### Volume Control of Key Tone

- To increase the volume of the key tones, press the top side [+] of the **Vol** button.
- To decrease the volume of the key tones, press the bottom side [-] of the **Vol** button.

**NOTE:** By pressing the **Vol** button in idle mode, the user can also adjust the key tone volume.

**LAST NUMBER REDIAL -** To redial the last dialed telephone number, press the **Func.** soft key scroll to **Last Redial** and press **OK.**

**PHONE BOOK BUTTON -** Provides direct access to Personal Phonebook (local to phone) or Company Phonebook (requires set-up by administrator).

**MESSAGE BUTTON -** This function allows users to select which desired type of messages is viewed. Users can select and view the following options: **Voicemail Messages, Station Messages, E-Mail** (optional with IP-UMS only), and **Short Message Service (SMS).** **Short Message Service** is similar to sending text messaging [Function only supported on Samsung IP phones].

**SERVICE BUTTON -** Used to allow station users access to setting and editing the scheduler (alarm clock) feature. Also used to connect the OfficeServ Communicator when application is available (UC is optional).

**MENU SOFT BUTTON-** This menu displays the following options:

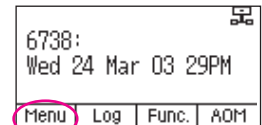

**NOTE:** The **Navigation** button can be used to scroll through these options.

1. **PHONEBOOK:** Maintains frequently dialed names and numbers in a Phonebook. Search and initiate calls by: Speed Dial, Associated Names, Telephone Numbers, Assigned Groups, or Previous Calls registered to your phone.
2. **CALL LOG:** Provides direct access to a list of most recent calls, outgoing calls, incoming calls, missed calls, and an option to delete/delete all (or clear) all calls from the **Call Log.**
3. **MESSAGES:** This function allows users to select which desired type of messages is viewed. Users can select and view the following options: **Voicemail Messages, Station Messages, E-Mail** (optional with IP-UMS only), and **Short Message Service (SMS).** Short Message Service is similar to sending text messaging [Function only supported on Samsung IP phones].
4. **CONFERENCE:** Allows a user to setup a **conference group** to call multiple parties simultaneously to join the conference call.
5. **SERVICE:** Allows a user to set the scheduler (alarm reminder) function.
6. **PHONE:** Allows the user to set many phone options for the phone such as ring tones, background screens, languages, forward, DND, etc.
7. **SETTINGS:** This function allows the user to set the following option: **Application Set., Call Forward, Absent Message, AOM Setting, Network Info., and Clear User Set.**

**CALL LOG SOFT BUTTON-** Provides direct access to a list of most recent calls, outgoing calls, incoming calls, missed calls, and an option to delete/delete all (or clear) all calls from the **Call Log**.

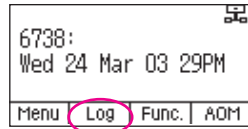

**FUNC. SOFT BUTTON -** This function allows a user one touch easy access to many of the system features. When pressed, the following options are displayed: Last number redial, Save/Repeat, Speed Dial, Directory, VM Message, Station Message, Page Pickup, Direct Pickup, DND, In/Out Group, Status Message, Hold pickup, Page, Meet me Page, OHVA Block, Group Pickup, and My Group Pickup. The **Navigation** button can be used to scroll up and down the list of features under the Func. button.

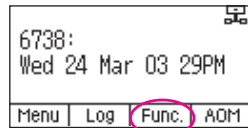

**NOTE:** **EXE/SECR MSG** is displayed only when the phone is programmed for Boss/Secretary feature.

**Example of using the Last Number Redial feature:**

- ▶ Press the **Func.** Soft button, scroll to **Last Redial**, then press **OK** button. The last number called from the phone is called.

**NOTE:** For detail operation of the list of features under the Func. soft button, please refer to the System Features section of the user guide.

**AOM SOFT BUTTON -** This function is used to display all 99 programmable feature buttons of the phone. The **Navigation** button can be used to scroll up and down the list of 99 programmable feature buttons under the soft AOM.

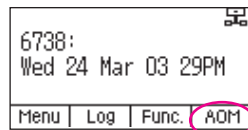

**Example of dialing a Speed Dial Number using the AOM function:**

- Press the **AOM** soft button, scroll to **Speed Dial**, then press **OK** button. The number is called from the phone.

**NOTE:** Some programmed features such as speed dialing and DSS buttons can be used to process calls; other programmed buttons such as Call buttons can only be viewed.

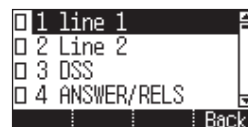

The soft AOM button can also display status indications for station keys, trunks, voice mail messages, etc.

**Example of programming a DSS button on the soft AOM:**

- Press the **Menu** soft button.
- Using the **Navigation** button, scroll to **Settings** and press **OK**, then scroll to and select **AOM Setting**.
- Scroll to the soft **AOM** button to program (for example: 4).
- Press the **Edit** soft button (the display will show AOM index 4).
- Press **Edit** soft button again, scroll to the feature option (for example: DSS).
- Move down and enter the extension number (for example: 2003).
- Move down, use the dial pad to enter name (for example: John Dow). [Refer to Text Input Method.](#)
- Press the **Save** soft button to exit and save the setting.

**OK/ENTER BUTTON -** This function is used to enter, save or complete the selected option in the display.

**SPEAKER BUTTON -** This function is used to go on and off hook in the hands-free speakerphone mode.

## SECTION 4. PHONE FEATURES

# BASIC MENUS

The basic menus screen is displayed if you select the **Menu** from the soft menu at the left bottom of a idle screen. Using the **Up/Down** button, move to a desired function, and press the **OK** button to execute the function.

## SOFT BUTTON STRUCTURE

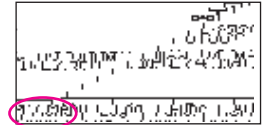

## MENU SOFT BUTTON

Item	Sub-Item	Description	
<b>1. Phonebook</b>	All	Shows the entire list of phone numbers stored in the phone.	
	<b>Personal Phonebook</b>	Unassigned	This is a list of number that are not assigned any group.
	Search	Allows a user to search for a registered phone number by name/number.	
	New	Saves a phone number or group name; and allows a user to specify a speed dialing number and ringtone.	
	Edit [+]	Allows a user to delete all the phone numbers saved in the phone.	
<b>2. Call Log</b>	Call	Used to make a callback from the call log.	
	Save	This is used to save entries from call log to phonebook.	
	[+] Delete	This is used to delete entries from the call log.	
	Back	This is used to to move back one menu screen.	
	Delete All	Allows a user to delete all the call history saved in the phone.	
<b>3. Messages</b>	1. Voice Mail [0]	Allows a user to retrieve voice mail messages from the mailbox.	
	2. Station Message [0]	Allows a user to retrieve station messages (internal) from another user.	
	3. Email [0]	Allows a user to to view how many e-mail messages have been received via IP-UMS (optional).	
	4. Short Message[0]	Allows a user to retrieve and send internal short messages (SMS) like text message to other internal phones. <i>[Not Supported Over Networking]</i>	



Item	Sub-Item	Description	
<b>4. Conference</b>		Allows a user to setup (show, add and edit) a <b>conference group</b> to call multiple parties simultaneously to join the conference call.	
<b>5. Service</b>		Allows a user to set the alarm clock function.	
	1. Scheduler	Allows the user to set a timed reminder alarm to give an audible indication or alarm clock function.	
<b>6. Phone</b>		Allows the user to set many phone options for the phone such as ring tones, background screens, languages, etc.	
	1. UC Dial: Right	Options are <b>DND</b> and <b>Absent Message</b> .	
	2. Screen	Options are <b>Display Time, Font,</b> and <b>LCD Power</b> .	
	3. Sound	Options are <b>Volumes, Ring Tone,</b> and <b>Key Tone</b> .	
	4. Language	Multiple languages are available.	
	5. Security	Change <b>Password, Dial</b> and <b>Phone Lock</b> .	
	6. Phone Information		<b>Easy Install:</b> Used to register and authenticate the phone to the server.
			<b>Phone Information:</b> Includes Version Info, Network Info, and MAC Address.
			<b>Network:</b> Options are Static IP, Dynamic IP, PPPoE, VLAN (LAN Port), VLAN (PC Port), 802.1x.
			<b>Server:</b> Used to register the phone to one or more Servers. Options are Primary, System 1, System 2, and System 3.
		<b>Extension Login:</b> Used to log phone on and off (Hot Desking).	
		<b>S/W Upgrade:</b> Upgrade Server, Upgrade: used to upgrade software on phones.	
		<b>Factory Reset:</b> Used to default the phone settings.	
	<b>Phone Restart:</b> Used to reboot the phones.		
	<b>License:</b> Display the licensing policy.		

Item	Sub-Item	Description	
<b>7. Settings</b>		This function is used to allow station users to set <b>application settings, call forwarding, absent messaging, AOM setting, view station network information, view phone firmware or initialize the phone</b> . Other settings include the following:	
	<i>Note: All options are not explained in this manual. The options are initiative and menu driven for an easy, user friendly menus to guide you through navigating the Setting Menu Options.</i>	1. Application Set.	Options are <b>Call</b> (CID 1, CID 2, Dial Mode), <b>Phone Number, Boss Answer, Short Message, Station On/Off,</b> and <b>Extension Login</b> .
		2. Call Forward	Options are <b>Not Use, All, Busy, No Answer, Busy/No Answer, DND,</b> and <b>Follow Me Status</b> .
		3. Absent Message	Used to leave <b>station messages</b> in display informing other internal parties of your status when your station is called.
		4. AOM Setting	Used to set the name and number function to the <b>99 AOM buttons</b> .
		5. Network Info.	Used to view the current <b>network settings</b> .
		6. Clear User Set.	<b>Clear</b> your local setting such as <b>phone-book, call log,</b> etc.

# 1. PHONEBOOK

Company phonebook requires setup by the System Administrator.



## PERSONAL PHONEBOOK

**NOTE:** Personal phonebook is stored locally in phone memory.

### All

Shows the entire list of phone numbers saved in the phone book.

- Press the **Phonebook** button—OR—press the **Menu** soft button, scroll to **Phonebook**, press **OK**, scroll to **All**, and then press **OK**.
- The entire list of phone numbers saved in the phone book is shown on the screen. Using the **Navigation** button, move to a desired entry, and select the **Call** soft button to place a call.

### Unassigned Group

The Unassigned option is a list of all the phonebook entries that have not been assigned to a group. Once an entry is assigned to a group, the entry is removed from the unassigned list.

## TO CREATE A PHONEBOOK GROUP

To create a group in the phonebook:

- Press the **Phonebook** button, then press the [+ ] soft button, then press the **New** soft button.
- Using the key pad, input the name of the group, then press the **Save** soft button. [See Text Input Method.](#)
- Press **Edit** soft button or press **Back** soft button to exit.

## TO MOVE UNASSIGNED ENTRY TO PHONEBOOK GROUP

- Press the **Phonebook** button, scroll to **Unassigned** option then press **OK** button.
- Scroll to the entry that is to be moved to an assigned group and press **OK** button.
- Press **Edit** soft button, scroll to and highlight the **Group** option.
- Using the **Navigation** button, move **Left** or **Right** to the group name (eg; Personal) which you want to move the entry into.
- Once the correct entry is displayed, press the **Save** button. The entry is now assigned to the group.

## Search

Allows a user to search by name/number for a phone saved in the phone book.

- Press the **Phonebook** button—OR—press the **Menu** soft button, scroll to **Phonebook**, press **OK**.
- Press the **Search** soft button from the dial pad enter the characters of the name (case sensitive) or number to search and press the **OK** button, the matching phone number is displayed. Move to a desired name/number using the **Navigation** button, and select the **Call** soft button to place a call.

## Add New Entry to Phone Book [+]

This is the function used to register a phone number.

- Press the **Phonebook** button—OR—press the **Menu** soft button, scroll to **Phonebook**, press **OK**.
- Press the [+ ] soft button, and then **New**.
- Enter a **name** by using the dial pad, scroll down and enter a **mobile number, home number, office number, internal extension number, fax number, and e-mail address**.
- Assign a **Group** (if needed).
- Select a **Ring Tone**.
- Add **Memo** information (up to 50 characters).
- Press the **Save** soft button to save the new entry to the Phone Book.

## DELETE / DELETE ALL

This is the function used to delete all the phone numbers saved in the phone book.

- Press the **Phonebook** button—OR—press the **Menu** soft button, scroll to **Phonebook**, press **OK**.
- Scroll to **All** and press **OK** button. Scroll to entry to delete.
- Press [+ ] soft button. Press **Del.** to delete the selected entry or **Del All**.
- Press the **Yes** to **Delete** entry.

# 2. CALL LOG

**Outgoing**

**Incoming**

**Missed Icons**

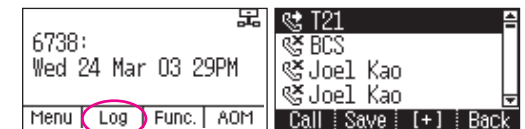

This function lists all the recent numbers for outgoing, incoming and missed calls.

- Press the **Log** soft button—OR—press the **Menu** soft button, scroll to **Call Log**, press **OK**. A phone number list of recent outgoing, incoming and missed calls is displayed.
- Scroll to an entry and press the **Call** soft button to dial the number.

## VIEWING DETAIL CALL LOG RECORD

To view the details of each of the call log entry, highlight the entry and press the OK button to display the full Caller ID record which includes the name, date and time.

## DELETE / DELETE ALL

This is the function used to delete an entry or all entries in the Call Log.

- Press the **Menu** soft button, scroll to **Call Log**, press **OK**.
- Scroll to entry to delete.
- Press **[+]** soft button. Press **Del.** to delete the selected entry or **Del All**.
- Press the **Yes** to **Delete** entry.

## TO ADD A CALL LOG ENTRY TO PHONE BOOK

- Press the **Menu** soft button, scroll to **Call Log**, press **OK**. Scroll to desired **Call Log entry** and press the **Edit** soft button. Make changes to the name and number if necessary. When finished, press the **Save** soft button. The Call Log number is added as a new entry to the phonebook list.

## 3. MESSAGES

### 1. Voice Mail

This function allows users to retrieve voice mail message from the mailbox.

- Press the **Message** button—**OR**—press **Menu** soft button, scroll to **Messages**, press **OK**, scroll to **Voice Mail [ ]**, and then press **OK** to access the voicemail box and retrieve messages.

### 2. Station Message

This function allows users to retrieve station messages (internal) from another user.

- Press the **Message** button—**OR**—press the **Menu** soft button, scroll to **Messages**, press **OK**, scroll to **Station MSG [ ]**, and then press **OK**.
- To return a call to the station that left the message: press the **Func.** soft button, scroll to **Reply**, then press **OK**.
- To delete the station message: press the **Func.** soft button, scroll to **Clear**, then press **OK**.
- To view the next station message: press the **Func.** soft button, scroll to **Next**, then press **OK**.



### 3. E-Mail

This function allows users to view the amount of e-mails for a station user's account. This function is only available when the IP-UMS application is enabled. Please refer to the IP-UMS manuals for detailed operation.

### 4. Short Message (SMS)

This function is used to send and create internal short messages or text messaging.

#### INBOX

- Press the **Message** button—**OR**—press the **Menu** soft button.
- Scroll to **Short Message**, press **OK**.
- Scroll to **Inbox**, then press **OK** to view a short text message(s) in you Inbox.
- Press the **[+]** soft button, press **Del.** soft button, and the **Yes** soft button to delete the selected short text message or press the **Back** soft button to exit Short Message.

#### NEW MESSAGE (SEND)

This function is used to create and send a new short text message.

- Press the **Message** button—**OR**—press the **Menu** soft button.
- Scroll to **Short Message**, press **OK**.
- Press **New Msg** soft button. Write or create a new short message and press the **Next** soft button. [See Text Input Method on how to enter characters in text messages.](#)
- Enter the internal extension(s) to send the short message. Scroll to other entries and enter the station number to send to more users. (Each short message can be sent to 1 through 10 users).
- Press the **Send** soft button to deliver the short message to other user's inbox.

#### NOTES:

1. When the message is sent successfully, the message "Sent" is displayed. When the message fails to send the "Failed to send" is displayed.
2. SMS messages can only be sent to internally ITP, SMT-W, or SMT-i phones. TDM and single line phones cannot send or receive SMS messages. SMS messaging is not supported over networking.

## OUTBOX

This function is used to create and send a new short text message.

- Press the **Message** button—**OR**—press the **Menu** soft button.
- Scroll to **Short Message**, press **OK**.
- Scroll to **Outbox**, then press **OK** to view short text message sent from your phone.
- Press the [+ ] soft button, then **Del/Del All** soft button to delete the short text message(s) or press the **Back** soft button to exit SMS.

## 4. CONFERENCE [Group]

This function allows a user to setup a conference group to call multiple parties simultaneously to join the conference call.



### CREATING CONFERENCE GROUP

- Press the **Menu** soft button, scroll to **Conference**, and press **OK**.
- Press **New** soft button, enter phone number (up to 4 numbers) of the parties included in the Conference Group.
- Press the **Call** soft button to initiate the Conference Group.

### TO CREATE AN UNSUPERVISED CONFERENCE

- During the conference, the host can press the **Host** soft button.
- The host is dropped and the other parties remain in conference.

### TO DISCONNECT A PARTY FROM CONFERENCE GROUP

- Highlight the party to be disconnected from the conference group.
- Press the **Disc.** soft button. The party is disconnected.
- Press the **Call** soft button to call back and add the party back to the conference group.

### SAVING A CONFERENCE GROUP

- After completing the group conference, press the **Save** soft button.
- Enter the **Name of the Group**, and press **Save** soft button.

### TO EDIT A CONFERENCE GROUP

- Press the **Menu** soft button, scroll to **Conference** button, and press **OK**.
- Scroll to the **Name of the Group** to be edited and press **Edit** soft button.
- Edit the group name. When complete, press the **Save** soft button to save changes.

## TO EDIT CONFERENCE GROUP PHONE NUMBER LIST

- Press the **Menu** soft button, scroll to **Conference** button, and press **OK**.
- Scroll to the **Name of the Group** to be edited and press **Edit** soft button.
- Press the **Edit** soft button. Edit the phone number list—**OR**—Press **Search** soft button to search for phone number to add to group from the phonebook. Highlight the entry and press the **OK** button to add the number to the Conference Group list.
- When complete with the editing, press the **Save** soft button to save changes.

## 5. SERVICE

Allows a user to set the alarm clock function.



- Press the **Service** button—**OR**—press the **Menu** soft button, scroll to **Scheduler**, then press **OK**.
- Press the **New** soft button.
- Enter the name of the scheduler using the dial pad and navigation buttons.
- Press the **Next** soft button. Enter the Date, Time, Alarm Type, and Ring Tone. Press **Save** soft button when finished.

### TO DELETE A SCHEDULE

- Press **Menu** soft button. Scroll to **Service** button, and press the **OK** button.
- Select **Scheduler** and press the **OK** button.
- To delete a current schedule, press the [+ ] soft button.
- Select and highlight the entry to be deleted and press **Delete** soft button—**OR**—press the **Delete All** soft button to clear all schedules.
- Select **Yes** to confirm or **No** to deny the deletion of a schedule(s).
- Press **Back** and **End** soft buttons to exit the scheduler.

## 6. PHONE

Allows the user to set many phone options for phone such as ring tones, background screens, languages, etc.

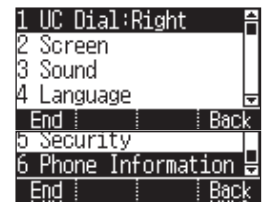

### 1. UC Dial: Right

This option is used to select which function will be enabled when the selector switch is moved to the right position.

- Press the **Menu** soft button. Scroll to **Phone** and press **OK**.
- Scroll to **UC Dial: Right** and press **OK**.
- Select **DND** or **Absent Message** and press **Save** soft button.

## 2. Screen

- Press the **Menu** soft button. Scroll to **Phone** and press **OK**. Select **Screen** and press **OK**. Set the following **Time Format, Font,** and **LCD Power Saving** of the SMT-i5230 phone, select the option and adjust the screen settings.
- Press the **Save** soft button to store the screen settings.

## 3. Sound

- Press the **Menu** soft button. Scroll to **Phone** and press **OK**. Select **Sound** and press **OK**. Set the following **Volumes, Ring Tone,** and **Key Tone** of the SMT-i5230 phone, select the option and adjust the sound settings.
- Press the **Save** soft button to save the sound settings.

## 4. Language

- Press the **Menu** soft button. Scroll to **Phone** and press **OK**. Select **Language** and press **OK**. Select English (Default English).
- Press the **Save** soft button.

## 5. Security

- Press the **Menu** soft button. Scroll to **Phone** and press **OK**. Scroll to **Security** and press **OK**.
- Enter the station password [default 1234].
- Press **OK** to Change Password and press **Back** soft button.
- Scroll to **Dial** to **Unlock, Lock Out** (Outgoing), or **Lock All**.
- Scroll to **Phone** to **Unlock** or **Lock** the Menu.
- Press the **Save** soft button.

## 6. Phone Information

Allows a user to set up the following options: **Easy Install Wizard** (registering the phone), **Phone Info** (Version, Network, MAC Address), **Network** (Static, Dynamic, etc.), **Server** (Phone can register to 1 to 4 servers), **Extension Login** (logging in and out IP phones), **Software Upgrade** (Upgrading the phone or server software), **Factory Reset** (defaulting the phone), and **Phone Restart** (rebooting the phone).

**NOTE:** The license policy can be viewed by pressing the **License** soft button.

## 7. SETTINGS

This function is used to allow station users to set **Application Settings, Call Forward, Absent Message, AOM Setting, Network Information,** and to **Clear User Settings** such as Call Log and Phonebook.

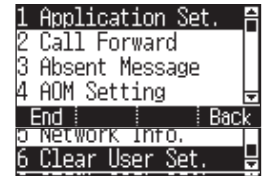

## FUNC. SOFT BUTTON

This function allows a user one touch easy access to many of the system features. When pressed, the following options are displayed: **Last Number Redial, Save/Repeat, Speed Dial, Directory, VM Message, Station Message, Page Pickup, Directory Pickup, DND, In/Out Group, Status Message, Hold Pickup, Page, Meet Me Page, OHVA Block, Group Pickup, and My Group Pickup.** The Navigation button can be used to scroll up and down the list of features under the **Func.** button.

**NOTE:** [For detailed operation of the list of features under the Func. soft button, please refer to the System Features section of this user guide.](#)

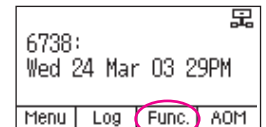

## AOM SOFT BUTTON

This function is used to display all 99 programmable feature buttons of the phone. The **Navigation** button can be used to scroll up and down the list of 99 programmable feature buttons under the AOM module. The feature buttons can be programmed by a technician.

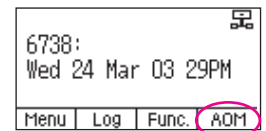

## SECTION 5. OFFICESERV™ 7000 SYSTEM FEATURES

### OUTSIDE CALLS

#### MAKING CALLS FROM AOM

**Note:** When making calls, internal or outside calls, in order to access the programmable button screens, press the **AOM** soft button. Then you can utilize the **Navigation** button to scroll the list.

- When the desired number is highlighted, press the **OK** button.
- The number will be automatically dialed.

#### UNIVERSAL ANSWER

Outside lines may be programmed to ring a general alerting device. To answer calls ringing this device, dial **67**—**OR**—press the **UA** button. This device can operate in any one of the six different ring plans.

**NOTE:** If the Hot Keypad feature has been turned off, you must first lift the handset or press the **Speaker** button before dialing.

#### RECALL DIAL TONE

- Press the **New** button to disconnect your existing call, wait for dial tone and then make a new call on the same line.

**NOTE:** If this button does not appear on your keyset, the **Flash** button may be programmed to recall dial tone.

#### SENDING A FLASH

While on an outside call, press the **Flash** button to send a flash to the telephone company. This is required for some custom calling features or CENTREX use.

**NOTE:** Flash is not available on an ISDN circuit.

#### BUSY LINE QUEUING WITH CALLBACK

If you receive a busy signal when you are selecting an outside line, this means that the line or group of lines is busy.

- Press the **Callback** button, if programmed, or dial **44**, you will hear confirmation tone.
- Hang up or press **Speaker** button.
- When the line becomes free, the system will call you back.
- Lift the handset or press the **Speaker** button to answer, wait for dial tone and dial the telephone number or speed dial number again.

#### NOTES:

1. A callback will be canceled if not answered within 30 seconds. If you have set a callback, the cursor associated with the **Callback** button will be solid black.
2. If the Hot Keypad feature has been turned off, you must first lift the handset or press the **Speaker** button before dialing.

## BUSY STATION CALLBACK

When you call another station and receive a busy signal:

- Press the **Callback** button, if programmed, or dial **44**.
- When the busy station becomes free, your keyset will ring.
- Lift the handset or press the **Speaker** button to call the now idle station.

#### NOTES:

1. A callback will be canceled if not answered within 30 seconds. If you have set a callback, the cursor associated with the **Callback** button, will be solid black.
2. If the Hot Keypad feature has been turned off, you must first lift the handset or press the **Speaker** button before dialing.

## CANCELING CALLBACK

A callback will be canceled if not answered within 30 seconds. If you have set a callback, the cursor associated with the **Callback** button, will be solid black.

To cancel a callback:

- Press the **Callback** button, if programmed, or dial **44**. The display will show the callback details, press the **Func.** soft button and then **Clear**.
- This will cancel the last set callback and display the next set callback, also with the option to **Clear**. This process is repeated until all callbacks are cleared from memory.

NOTE: If the Hot Keypad feature is turned off, you must first lift the handset or press the **Speaker** button before dialing.

## BUSY STATION CAMP-ON

When you call another station and receive a busy signal but you do not want to wait for a callback:

#### MANUAL CAMP-ON

- Press the **Camp** button or dial **45**.
- The called station will receive off-hook ring tone repeated every few seconds and the cursor associated with the first available **Call** button will flash black to indicate your call is waiting.
- Wait for the called party to answer.

- The called station must release its first call or place it on hold before answering your camp-on.

#### NOTES:

1. If you receive No More Calls tone, that station has no available button to accept your call. Hang up or leave a message.
2. If the Hot Keypad feature has been turned off, you must first lift the handset or press the **Speaker** button before dialing.

#### AUTO CAMP-ON

When you want to automatically camp on to a busy station without pressing the camp on button every time you call a busy station, you can set your phone for auto camp-on.

- With the handset on-hook, press **Transfer** and then dial **110**.
- Dial **081** to turn **On** auto camp-on or dial **080** to turn it **Off**.
- Press **Transfer** to store your selection.

# INTERCOM CALLS

## VOICE ANNOUNCE MODE

When another station calls you, your keyset will sound a brief attention tone and you will hear the caller's announcement.

- Press the **Speaker** button to turn on the microphone and speak handsfree—**OR**—lift the handset to reply.
- To finish the call, replace the handset or press the **Speaker** button.

NOTE: In order for C.O. calls to be answered handsfree, AUTO ANS CO must be set to ON.

## AUTO ANSWER MODE

When another station calls you, your keyset will sound a brief attention tone and then automatically answer the call.

- Your microphone and speaker are turned on and you can speak handsfree. For privacy, use the handset.
- To finish the call, replace the handset.

NOTE: In order for C.O. calls to be answered handsfree, AUTO ANS CO must be set to ON.

## CALLING YOUR SYSTEM OPERATOR

- Dial **0** to call your system operator or group of operators.
- If you want to call a specific operator, dial that person's extension number.

NOTE: If the Hot keypad feature has been turned off, you must first lift the handset or press the **Speaker** button or dial **0** before you begin dialing.

# CALL PROCESSING

## SYSTEM HOLD

When you are connected to any call, press **Hold**. The call will flash at the keyset. If this call appears on a line button at other keysets, it will flash at those keysets also.

- To take the caller off hold, press that button and the flashing LED will go steady again. Resume the conversation—**OR**—press the **Hold** button. The flashing LED will go steady again and you will be connected to the call again. Resume the conversation.

NOTE: While on a call, pressing a line button, route button or flashing **Call** button will automatically put your first call on hold and connect you to the new call. [See Automatic Hold under Customizing Your Keyset.](#)

## EXCLUSIVE HOLD

To place an outside call on hold at your phone so that other users cannot get it:

- Press the **Hold** button twice. The call will flash on your keyset and this line will show a steady indication on other keysets.
- To retrieve the call, press the flashing line button or press the **Hold** button a third time.

NOTE: Intercom calls will always be placed on exclusive hold.

## REMOTE HOLD

When you wish to place a call on hold at another station.

- Press **Transfer** and dial the station number (or press the appropriate **DSS** button)
- Press the **Hold** button. This will place the call on system hold on an available **Call** button or Line button at the remote station and return you to dial tone.

NOTES:

1. If the destination station does not have any free **Call** buttons or line buttons you will hear No More Calls tone and must return to the other party by pressing the **Transfer** button.
2. Intercom calls cannot be put on remote hold.



## HOLD RECALL

If you leave a call on hold longer than the hold timer, it will recall your station. The button that the call appears on will have a slow flashing indicator.

- When your phone rings, lift the handset or press the **Speaker** button to answer the recall.
- If you do not answer this recall within a pre-programmed period of time, it will go to the system operator.

NOTE: The Led will flash amber during hold recall.

## CONSULTATION HOLD

When you are talking on an outside line and it is necessary to consult with another extension:

- Press the **Transfer** button; you will receive transfer dial tone. Your call is placed on transfer hold.
- Dial the extension number.
- Consult with the internal party.
- Press **Transfer** to return to the outside party or hang up to transfer the call.

NOTE: Repeatedly pressing the **Transfer** button will toggle between the outside party and internal extension. If necessary you may disconnect either one of the parties by pressing the **Func.** soft button, then press the **Cancel** soft button.

## RETRIEVING CALLS HELD AT ANOTHER STATION [HOLD PICKUP]

When a line is on hold and it appears on your keyset, press the **Line** button with the flashing indicator.

When a line is on hold and it does not appear on your keyset, dial **12** plus the line number or the extension number of the station that placed the call on hold.

NOTE: If the Hot Keypad feature has been turned off, you must first lift the handset or press the **Speaker** button before you begin dialing.

## CALL TRANSFER

Transfer is used to send any calls to another extension in one of two ways. You can do a screened transfer by informing the other extension who is calling or you can do a blind transfer without notification.

- While on a call, press the **Transfer** button and dial an extension number or group number. Your call is automatically put on transfer hold—**OR**—press a **DSS** button or station group button. Your call is automatically put on transfer hold.
- Hang up when you hear ringing (this is an unscreened or blind transfer)—**OR**—wait for the called party to answer and advise him/her of the call and hang up. If the transfer is refused, you will be reconnected to the outside line when the called station hangs up or you can press **Transfer** to return to the outside party.
- If you wish to send the call to another extension without waiting for the first station to hang up, simply press another **DSS** button—**OR**—press the **Call** button or C.O. line button to return to the outside party and begin the transfer process again.
- When you are transferring a call to a keyset set for Voice Announce or Auto Answer, the transferred call will always ring.

NOTES:

1. After the inside party answers, you may alternate back and forth between the parties by pressing the **Transfer** button.
2. If you receive No More Calls tone, that station has no button available to receive another call. Press **Transfer** to return to the other party.
3. You cannot transfer an Intercom call by pressing a **DSS** button. You must press the **Transfer** button and dial the destination extension number.

## TRANSFER WITH CAMP-ON

When you are transferring a call to another station and you receive a busy signal, you may camp the call on to this station. Simply hang up when you hear the busy signal. The called party will be alerted that a call is waiting for them.

NOTE: If you receive No More Calls tone, that station has no button available to receive another call. Press **Transfer** to return to the outside caller.

## TRANSFER TO VOICE MAIL

This feature is used to send a call directly to a voice mailbox. Your keyset must have a correctly programmed **VT** button to accomplish this. To transfer a call directly to a voice mailbox:

- While on a call, press the **VT** button and dial the mailbox number.
- Hang up when dialing is completed.

## CALL WAITING

If an outside call has been camped-on to your phone or another station has camped-on to you:

- You will hear a tone in the earpiece and the call that is waiting for you (camped-on) will flash. In addition the bottom line of the display will indicate the number of the station or trunk party camped-on.
- Press the flashing button to answer; your other call will go on hold automatically if your station has the Automatic Hold feature set. If not, you must press **Hold** and then the flashing button—**OR**—finish the first call and hang up; the waiting call will ring.
- Lift the handset or press the **Speaker** button to answer.

NOTE: Intercom calls will not go on Automatic Hold. When using the speakerphone the camp-on tone will come through the speaker.

## CALL FORWARD OPTIONS

A display keyset may review or change call forward options and destinations. Call forward access can be done via the keypad or by accessing the keyset display features. To review or change call forward options:

- Press the **Menu** button, scroll to **Settings**, press the **OK** button.
- Scroll to **Call Forward** and press the **OK** button.
- Scroll to the desired Forwarding option, enter the destination extension, and press the Save soft button.  
—**OR**—
- Press **Transfer 102**.
- Dial **0-5** to select the forward type (e.g., 1)—**OR**—  
Press **Volume Up** [+] or **Volume Down** [-] to select the forward type  
Press the right soft key to move the cursor.
- Dial the destination number (e.g., **202**)—**OR**—  
Press **Volume Up** [+] or **Volume Down** [-] to select the destination and press the **Right** soft key to move the cursor.
- Dial **1** to set—**OR**—press **Volume Up** [+] or **Volume Down** [-] to select **Yes** or **No** and press **Transfer** to store and exit.  
—**OR**—

### To Forward ALL Calls to Another Station

- Dial **601** plus the extension or group number.
- Receive a confirmation tone and hang up.

### To Forward Calls to Another Station when you are on the Phone (BUSY):

- Dial **602** plus the extension or group number.
- Receive a confirmation tone and hang up.

### To Forward Calls to Another Station when you DO NOT ANSWER:

- Dial **603** plus the extension or group number.
- Receive a confirmation tone and hang up.

### When you have both Forward ON BUSY and Forward NO ANSWER Destination Programmed:

- You can activate them simultaneously.
- Dial **604**. Receive a confirmation tone and hang up.

### To Forward Calls when DND is Activated:

- Dial **605** plus the extension or group number.
- Receive a confirmation tone and hang up.

### To Forward Calls to the Station Where You Currently Are (FORWARD FOLLOW ME):

- Dial **606** plus the extension or group number.
- Receive a confirmation tone and hang up.

To clear all call forward conditions set at your station lift the handset and dial **600**.

## STATION CALL PICKUP

To answer a call ringing at another station, lift the handset and dial **65** plus the extension number of the ringing phone. If you have a DP key assigned with a station number, you only need to press this **DP** (Direct Pickup) key with the flashing light to answer this ringing station. NOTE: If the Hot Keypad feature has been turned off, you must first lift the handset or press the **Speaker** button before you begin dialing.

## GROUP CALL PICKUP

To pick up (answer) a call ringing in any pickup group, lift the handset and dial **66** plus the desired group number (**01-10** on the **OfficeServ 7030**, **01-20** on the **OfficeServ 7200-S**, **01-99**, and **01-99** on the **OfficeServ 7000 Series**) or press the flashing **GROUP PICKUP** button if available.

NOTES:

1. A group pickup button can have an extender for a specific pickup group.
2. If the Hot Keypad feature has been turned off, you must first lift the handset or press the **Speaker** button before dialing the access code.

## MY GROUP PICKUP

If desired, a new access code can be assigned to pickup ringing calls in the same pickup group as you are in. Like "66" above except you do not need to dial the desired group number. See your installation company for the assigned access code. MY GROUP PICKUP: \_\_\_\_\_.

## PRIVACY RELEASE

This feature will allow another station to join in our conversation by releasing privacy on the C.O. from your phone.

**To Release Privacy:** While you are talking on a C.O. line and you wish to have other internal parties (or up to three) join the conversation.

- Press the **PRB** button (the **PRB** indicator will be steady). Inform the other party that he/she may now join the conversation.

After the other party (or parties) has joined the conversation and you wish to return privacy to the line so that no one else can join the conversation, press the **PRB** button a second time, the **PRB** button LED will be off.

**To Join a Non-Private Conversation:** When someone has informed you that you can join a conversation:

- Press the **C.O. line** button that he/she has indicated OR
- Dial the **C.O. line number** that he/she has indicated.

## DIALING FEATURES

All "DIALING FEATURES" instructions are written to support Overlap Dialing mode. This is the technical name for dialing from a telephone as it has been for many years. In recent years the cell phone industry has changed the cell phones to use Enblock Dialing. With this dialing mode all the digits are dialed and then sent to the carrier after pressing the CALL key. Please check your telephone setup to confirm what dialing mode is used.

## SPEED DIALING

You can dial a preprogrammed telephone number stored in the system-wide speed dial list of numbers 500–999 or from your personal list of numbers 00–49.

Your system may be set for 950 system wide numbers. If so the system speed dial access codes are 050~999 and the station speed dial codes are 000~049.

- From the idle screen with the handset on-hook, press the **AOM** soft button, or dial **16**, scroll to the **Speed Dial** button, press the **OK** button.
- Dial the desired speed dial bin number.
- The telephone number is automatically dialed for you.

NOTE: If the Hot Keypad feature has been turned off, you must first lift the handset or press the **Speaker** button before you begin dialing.

## PROGRAMMING PERSONAL SPEED DIAL NUMBERS

You can program frequently dialed telephone numbers in a personal speed dial list. A station may be assigned up to fifty numbers, **00–49**. See your system administrator to determine the amount assigned to your station. The phone itself maintains 1000 station speed dial numbers.

- While on-hook, press **Transfer** and then dial **105**.
- Dial a speed dial number (**00–49**).
- Dial a line or line group access code.
- Dial the telephone number to be stored (24 digits maximum). It can include #, \*, FLASH and PAUSE.
- Press **Transfer** to store the number.

NOTE: If the Hot Keypad feature has been turned off, you must first lift the handset or press the **Speaker** key before you begin dialing.

For the purposes of programming speed dial numbers, the programmable buttons are known as **A**, **B**, **C**, **D**, **E**, and **F**.



- The **A** button is not used.
- The **B** button inserts a flash.
- The **C** button inserts a pause.
- The **D** button is used for pulse to tone conversion. If your system uses rotary (or pulse) dialing C.O. lines, pressing **D** while entering a speed dial number causes all subsequent digits to be sent as DTMF tones.
- The **E** button is used to hide digits. Display keyset users may want to hide some speed dial numbers so that they will not show in the display. When you are entering a telephone number, press **E**. All subsequent digits will be hidden. Press **E** again to begin displaying digits.
- The **F** button is used to enter a speed dial name or number. [See Personal Speed Dial Names under Display Features.](#)
- Use the **Hold** button to clear a speed dial number.

## DIRECTORY DIALING

- Press the **Func.** soft button, scroll to **Directory**, press **OK**.
- Press **Func.** soft button, scroll to the desired **directory**, press **OK**.

**STATION DIRECTORY** - Accesses Station name directory.

**PERSONAL DIRECTORY** - Accesses your personal speed dial name list.

**SYSTEM DIRECTORY** - Accesses System speed dial name list.

- Enter the first letter of the desired party.
- Press the +/- buttons to scroll to the desired entry.
- Press the **Func.** soft button.
- Select the appropriate operation, press **OK**.

**DIAL** - Dials the displayed number.

**EXIT** - Exit programming and return to idle screen.

**PREVIOUS** - Moves you to the previous entry.

**NEXT** - Moves you to the next entry.

- Press **Back** to return to idle screen.

## LAST NUMBER REDIAL

To redial the last outgoing telephone number you dialed, press the **Func.** soft button, scroll to **Last Redial**, or dial **19**.

NOTES:

1. If the Hot Keypad feature has been turned off, you must first lift the handset or press the **Speaker** button before you begin dialing.
2. Redial does not apply to intercom calls.

## SAVE NUMBER WITH REDIAL

To save the number you just dialed for later use, press the **Save/Repeat** button before hanging up.

To redial this saved number at any time, press the **Func.** soft button, scroll to **Save/Repeat**, press **OK** button or dial **17**. The same line will be selected for you.

NOTES:

1. If the Hot Keypad feature has been turned off, you must first lift the handset or press the **Speaker** button before you begin dialing.
2. The saved telephone number is stored in memory until you save another number.
3. Redial does not apply to intercom calls.

## AUTOMATIC REDIAL/RETRY

When you are making an outside call and you receive a busy signal, the system can automatically redial the number for you. It will automatically redial at a pre-programmed interval for up to 15 attempts.

- When you hear a busy signal, press the **Retry** button.
- The system will reserve the line and automatically redial the same number for you. You will hear the call being made through the keyset speaker. The microphone is muted.
- When the called party answers, lift the handset or press the flashing **Speaker** to begin speaking.

NOTES:

1. If you make another call, auto-redial is canceled.
2. To cancel an auto-retry, lift and replace the handset.

## PULSE TO TONE CHANGEOVER

When making an outside call on a dial pulse line, press **#**. All digits dialed after the **#** will be sent as tones.

# PAGING AND MESSAGING

## MAKING AN INTERNAL PAGE

To make an announcement through the keyset speakers in the idle condition:

- Lift the handset.
- Press the **Func.** soft button, scroll to **Page** button, press **OK** or dial **55**.
- Dial the desired zone number **0, 1, 2, 3** or **4**.
- After the attention tone, make your announcement.

### NOTES:

1. If you have a dedicated page zone button, it is not necessary to press **Page** and dial a zone number.
2. If allowed by your system administrator you may be able to initiate a page from a speakerphone by pressing the **Page** key or dialing **55** without lifting the handset.

## MAKING AN EXTERNAL PAGE

To make an announcement through the external paging speakers:

- Lift the handset.
- Press the **Func.** soft button, scroll to **Page** button, press **OK** or dial **55**.
- Dial the desired zone number **5, 6, 7** or **8**—**OR**—dial **9** to page all external zones.
- After the attention tone, make your announcement.

### NOTES:

1. If you have a dedicated page zone button, it is not necessary to press **Page** and dial a zone number.
2. If allowed by your system administrator you may be able to initiate a page from a speakerphone by pressing the **Page** key or dialing **55** without lifting the handset.

## ALL PAGE

To page all designated keysets in internal zone 0 and all external zones at the same time:

- Lift the handset.
- Press the **Func.** soft button, scroll to **Page** button, press **OK** or dial **55**.
- Dial **\*** or press the **All Page** button.
- After the attention tone, make your announcement.

### NOTES:

1. The LED on the **Page** button will only light when an All Page is in progress.
2. If allowed by your system administrator you may be able to initiate a page from a speakerphone by pressing the **Page** key or dialing **55** without lifting the handset.

## MEET ME PAGE

- Lift the handset.
- Press the Meet Me Page (**MMPG**) button or dial **54**.
- Dial the desired zone number.
- After the attention tone, instruct the paged person to dial **56**.
- Press **Func.** soft button, then **Answer Wait**, then **OK** button.
- Remain off-hook until the person dials **56** from any phone.
- The paged person will be automatically connected with you.

## CALL PARK AND PAGE

When you have an outside call for someone who is not at his/her desk, you can park the call prior to paging. The OfficeServ 100, OfficeServ 500, and OfficeServ 7000 Series systems offer two different methods:

### MANUAL PARK ORBITS

- While in conversation, press the **Park** button.
- Entered a desired orbit number (**0-9**), if the orbit number is busy dial another orbit number. Display users can press **\*** to automatically place the call in any available orbit number and see the number in the display.
- Remember the selected orbit number.
- Replace the handset when finished.
- Lift the handset and make a page announcement as previously described (example: "John Smith park two").

### To retrieve a parked call from orbit:

- Press the **Park** button and dial the announced orbit number (**0-9**).
- You will be connected to the parked call.

### NOTES:

1. You must have a **Park** button or park access code to retrieve and place calls in park orbits.
2. If the parked call is not retrieved within a pre-programmed period of time, it will recall your keyset and have a slow flashing amber light. You cannot park and page intercom calls.
3. If the Hot Keypad feature has been turned off, you must first lift the handset or press the **Speaker** button before you begin dialing.

## AUTOMATIC PARK WITH PAGE BUTTON

- While in conversation, press the **Page** button. The call is automatically parked at your station.
- Receive page tone and dial a desired page zone number.
- Make announcement indicating your extension number or the line number. Hang up.

### To retrieve an automatically parked call:

- Dial **10** plus the number that was announced. If you have a **PAGPK** button, press it and dial the number that was announced. If you have a **Park** button, press it and dial the announced orbit number.
- You will be connected to the parked call.

### NOTES:

1. If the call is not retrieved within a pre-programmed period of time, it will recall your keyset and have a slow flashing amber light. You cannot park and page intercom calls.
2. If the Hot Keypad feature has been turned off, you must first lift the handset or press the **Speaker** button before you begin dialing.

## SETTING A MESSAGE INDICATION

When you are calling another station and no one answers or you receive a busy signal, you can leave a message indication:

- Press the **Func.** soft button, scroll to **Message**, press **OK—OR—dial 43** and receive confirmation tone. Hang up.
- The message button on the Main Programmable Button screen and the TSI will flash red at the called station.

### NOTES:

1. A station can have up to five message indications.
2. If the Hot Keypad feature has been turned off, you must first lift the handset or press the **Speaker** button before you begin dialing.

## CANCELING MESSAGES

To cancel a message indication that you left at another station, dial **42** plus the extension number of the station at which you left a message.

- To cancel all message indications left at your keyset, dial **42** plus your extension. Your **Message** button indicator will stop flashing and the TSI will go out.

NOTE: If the Hot Keypad feature has been turned off, you must first lift the handset or press the **Speaker** button before you begin dialing.

### —OR—

- Press **Message** button, scroll to **Station Messages**, press **OK**.
- Press **Func.** soft button, scroll to **Clear**, press **OK**.

## RETURNING MESSAGES

- Press **Menu**, scroll to **Message**, press **OK**, scroll to **Station Message**, press **OK**, press **Func.** soft button, press **REPLY**, and then press **OK**, or dial **43**. The first station that left a message will be called automatically. If that station does not answer, the called station **Message** button indicator will continue to flash and the TSI will stay on.
- Repeat until all messages have been returned in the order received.
- Your **Message** button indicator will stop flashing and the TSI will turn off when all messages have been returned.

### NOTES:

1. Display keyset users can view message indications and return them in any order. [See Viewing Message Indications under Display Features.](#)
2. If the Hot Keypad feature has been turned off, you must first lift the handset or press the **Speaker** button before you begin dialing.
3. If a message has been left at your keyset by a keyset in Auto Answer, you must manually cancel the message after it has been returned.

## PROGRAMMED MESSAGES

When you will be away from your phone for any length of time, you can leave a programmed station message. Display stations calling you will see this message and be informed of your status or follow your instructions.

- Dial **48** plus any of the message codes (**01–20**) listed on the back of this user guide.
- To cancel any of these messages you might have selected, dial **48** plus **00**.
- Press **Transfer** to exit and store your selection.

NOTE: If the Hot Keypad feature has been turned off, you must first lift the handset or press the **Speaker** button.

You can have multiple programmed message buttons (**PMSG**) and each one can have a different message code:

- Press any programmed message (**PMSG**) button. The message is set and the PGM MSG button indicator will be lit steady. Press the button again to turn off the programmed message and the indicator will go blank.
- Pressing another programmed message (**PMSG**) button will turn the previous one off and set a different programmed message.

# CONVENIENCE FEATURES

## LOGGING IN AND OUT

If enabled, your SMT-i5230 telephone may require you to log in before making or receiving calls. In these cases your telephone system administrator will provide you with an extension number, password, and the feature code used to log out.

### To log in:

- At **Extension Login Screen** enter your ID which is your extension number.
- Scroll down to the password field and enter your station password
- Press on **Save** soft button or **OK** button.

### To log out:

- Dial the feature code provided by your administrator (for example 77).

## DO NOT DISTURB

Use this feature when you want to block calls to your keyset.

- While on-hook, press the **Func.** soft button, scroll to **DND**, press **OK**, press **1** to turn it **ON**, or dial **401**. The **DND** button indicator will be lit steady to remind you of this mode.
- To cancel **DND**, press the **Func.** soft button, scroll to **DND**, press **OK**, press **0** to turn it **OFF**, or dial **400**. The **DND** button indicator goes blank. You can make calls while in the DND mode.

### NOTES:

1. If the Hot Keypad feature has been turned off, you must first lift the handset or press the **Speaker** button.
2. If you place your keyset in **DND** mode and you do not have a **DND** button, your **Telephone Status Indicator** button will fast flash red to indicate DND status.
3. The **selector switch** can also be used to set DND.

## ONE TIME DND

If you are on a call and you do not wish to be interrupted while on that call, you can press the **DND** button and place your station in Do Not Disturb. When you hang up at the end of the call, DND will be automatically canceled and your keyset will be able to receive new calls. This feature requires a **DND** button.

## MUTE

You can mute the handset transmitter or the microphone during any conversation:

- Press the **Mute** button. The **Mute** button indicator will be lit steady.
- To resume speaking, press the **Mute** button again. The **Mute** button indicator goes blank.

## BACKGROUND MUSIC

When a music source is supplied, you may listen to music through the speaker in your keyset:

- While on-hook, press the **Hold** button to hear music.
- Press the **Hold** button again to turn music off.

You can set the level of background music by using the **Volume** buttons while listening to the music. This does not affect the speakerphone level.

## ESTABLISHED CALL PICKUP

To pick up an established call in progress at a single line extension connected to a computer modem on your PC.

- Press the **EP** button for that station on your keyset and the call is automatically moved to your keyset.
- The single line extension on your modem will be disconnected.

NOTE: You must have an assigned (**EP** button) button on your regular keyset, for the single line station.

## ANSWERING THE DOOR PHONE

When you are programmed to receive calls from a door phone:

- You will receive three short rings repeated.
- Lift the handset. You are connected to the door phone.
- If an electric door lock release is installed, dial **13** to unlock the door.

## CALLING THE DOOR PHONE/ ROOM MONITOR

You may call the door phone and listen to what may be happening outside or in another room.

- Dial the extension number of the door phone.
- You will be connected to the door phone and you can listen or have a conversation.
- If an electric door lock release is installed, dial **13** to unlock the door.

NOTE: If the Hot Keypad feature has been turned off, you must first lift the handset or press the **Speaker** button.

## EXECUTIVE/SECRETARY [HOT LINE]

If programmed, an executive boss and a secretary can have a hot line between them. When the executive station is in the DND mode, all of its calls will ring the secretary station. If the secretary does not answer, the caller will go to the secretary's voice mail box if setup.

When an Executive/Secretary hotline is programmed to this keyset, the keyset offers an additional screen option. This screen has options for setting the status of the keyset user. This status update is viewable to EasySet users only.

- Either person can press the **Boss** button to make a voice call to the other station.
- Using the hot line will override DND at the other station. This button will have a flashing indication when the other station is in use.

### To transfer a call to a Boss in DND:

- Press the **Boss** button.
- Wait for the **Boss** to answer, then announce the call and hang up to complete the transfer—**OR**—hang up to complete a blind transfer.

### Executive/Secretary (Messaging):

When the Boss or Secretary is needing to inform the other party of their current status, they can send a message to their display.

- Press the **Func.** soft button. Scroll to **EXE/SECR MSG** and press **OK**.
- Select and highlight one of the **Return On** messages and press the **Edit** soft button.
- Press and hold the **Delete** soft button to erase the default message.
- Using the dial pad, type in the new message ([refer to Text Input Method](#)).
- When finished press the **Save** then the **Send** soft button to display the message on the other (Boss/Secretary) phone.

## GROUP LISTENING

When you are engaged on a call and you are using the handset, you may want other people to hear the distant party's voice over the speaker:

- Press the **Listen** button to turn on the speaker. The microphone is not in use, so the distant party does not hear other parties present in your office.
- Press **Listen** again to turn the speaker off and resume private conversation.
- Repeat if necessary.  
—**OR**—
- During a conversation, press **Func.** scroll to **Group Listen** and press **OK**.

NOTE: Depending on speaker volume and the acoustics of your office, it may be advisable to turn the group listening feature off before hanging up. This will eliminate a momentary squeal.

## ACCOUNT CODES

When enabled, your system allows calls to be charged to different accounts. You can enter account codes either by dialing the full code, by entering an account code "bin number," or by pressing your **ACC (Account)** key if one is assigned. Bin numbers are a 3 digit short code that will automatically insert the appropriate account code. Account codes may be a maximum of 12 digits (# may be used); if the account code is to be less than 12 characters you may end the code by pressing **\*** or the right soft key. The type of code used is determined by your telephone system administrator. Codes can be entered before or during a call as follows:

### To enter an account code before placing the call:

- Press your **ACC (Account)** key or dial **47**.
- Dial the account code or bin number.
- You will receive a confirmation tone and display.
- When prompted dial a trunk or trunk group (i.e. 9) and the telephone number to call.

### To enter an account code by interrupting the conversation:

- While on an outside call press the **ACC (Account)** key or press **Transfer** followed by **47**.
- Dial the account number or bin number (if you are entering an account code you will need to press your **ACC (Account)** key or right soft key to finalize the entry)

NOTE: If you make an error simply repeat the procedure with the correct code. Only the most recent account code dialed will be recorded.



## LOCKING YOUR KEYSET

You can lock your keyset to control misuse of your phone while you are away. You can unlock it when you return.

- Press **Menu** button, scroll to **Phone**, press **OK**.
- Scroll to **Security** option. Press **OK**.
- Enter the **Password** [Default Password is "1234"]. Press **Enter**.
- There are three options available:

**CHANGE PASSWORD:** This can be used to change the station password.

**DIAL:** Allows the station user the option to select **Lock All**, **Lock Outgoing**, or **Unlocked**.

1. **UNLOCKED** - No restrictions. User may complete internal and outside calls.
2. **LOCK OUTGOING** - Restricted to incoming calls only. No outside calls can be made. When 911 is programmed, 911 emergency dialing is allowed.
3. **LOCK ALL** - No calls, incoming or outgoing allowed to or from the set.

**PHONE MODE:** Allows the user to lock or unlock the menu from being changed at the station.

- Use the navigation soft button to scroll **Left/Right** to choose the desired mode.
- Press the **OK** button.
- Press the **Back** soft button to return to **Menu**, and press **Back** soft button again to return to idle screen.

## MANUAL SIGNALLING

Use this feature when you want to send a brief 500ms ring burst to another station, regardless of the status of your phone (on-hook, off-hook, handsfree, DND, or ringing).

**To send a signal to another station:**

- Press the Manual Signalling (**MS**) button.
- You may press the **MS** button repeatedly to send multiple signals to the designated station.

**NOTE:** Your phone must have a Manual Signalling (MS) button with a station number extender assigned to it. Manual Signalling will override DND.

## OFF-HOOK VOICE ANNOUNCE

Keysets may receive a voice announcement while on another call. The calling station must have an **OHVA** button. When you are in DND, you cannot receive OHVA calls. The OHVA feature will work with intercom and transferred calls.

When you receive an OHVA and secure OHVA is ON, you will hear the announcement in the handset receiver, if you are using the handset. If secure OHVA is OFF then you will hear the announcement on the speaker, if you are talking on the handset. If you are using the speakerphone the announcement will always be heard through the speaker.

**To make an off-hook voice announcement:**

- Dial the extension number or press the **DSS** button.
- When you receive a busy signal, press the **OHVA** button.
- After the attention tone, begin speaking.
- Finish the call by replacing the handset.
- Press the flashing **Call** button on your keyset. This will place the original party on hold and allow you to talk to the announcing party.
- To return to your first party, press the button corresponding to your original call. This will disconnect the OHVA call.

**NOTES:**

1. When you are voice announcing to a station close to you, use the handset to avoid an echo effect.
2. You cannot off-hook voice announce to single line telephones.

## OHVA BLOCK

Your keyset can be programmed with an OHVA Block (**Block**) button. Pressing this button will prevent anyone from making an OHVA to you until you press the button again and cancel the blocking.

## OHVA REJECT

Your keyset can be programmed with an OHVA Reject (**Reject**) button. Pressing this button while receiving an OHVA call will disconnect the voice announcing party and return you to your original call.

## IN GROUP/OUT OF GROUP

If your keyset is assigned to a station ring group, you can remove your keyset from the group and then put it back in. While you are out of the group, you can receive calls to your extension number but not calls to the group number. If you have an **IO GRP (IN/OUT GRP)** button with the group number assigned.

- Press the **IO GRP (IN/OUT GRP)** button. The button indicator will be lit steady when your keyset is in the group.
- Press the **IO GRP (IN/OUT GRP)** button again to exit the group and the indicator will go blank. Repeat as necessary.

If you do not have an **IO GRP (IN/OUT GRP)** button:

- Dial the **IO GRP (IN/OUT GRP)** access code number \_\_\_\_\_, then the group number, then **0** to exit the group or **1** to enter the group.

NOTE: If the Hot Keypad feature has been turned off, you must first lift the handset or press **Speaker** button.

The **IO GRP (IN/OUT GRP)** button can include an extender to indicate the specific group that this button will affect. This means that if you are in multiple groups, you can decide for which groups you will receive calls.

## CUSTOMIZING YOUR KEYSSET

### AME PASSWORD

This feature allows customers using the AME feature to enable password protection. This will prevent unauthorized users from listening to your messages being left. The passcode is the same as your station passcode. This feature only applies if there is a Samsung Voicemail card installed in the system and your keyset has a programmed AME button.

- With the handset on-hook, press **Transfer** and then dial **110**.
- Dial **101** to turn on AME PASSCODE or **100** to turn it off.
- Press **Transfer** to store your selection.

### AUTO CAMP-ON

This option allows intercom calls to be automatically camped on, if possible, when a busy station is called.

- With the handset on-hook, press **Transfer** and then dial **110**.
- Press **081** to turn CAMP-ON on or **080** to turn it off.
- Press **Transfer** to store your selection.

### SELECT RING TONE

Each SMT-i5230 user can select from a variety of ring tones.

**From the LCD:**

- Press **Menu** button, scroll to **Phone**, press **OK**.
- Scroll to **Sound** option and press **OK**.
- Select **Ring Tone** and press **OK—OR—**you may dial **1** and immediately enter the option.
- Use **Navigation** button to scroll through the available ring tones and press **OK** or **Save** soft button to store your selection.
- Press **End** soft button to return to idle screen.

### CHANGE YOUR PASSCODE

From the factory, your station passcode is 1234. You can change your station passcode whenever you desire.

- While on-hook, press **Transfer** and then dial **101**.
- Dial your old passcode.
- Dial a new passcode (must be four characters). You can use **0–9**.

- Redial the new passcode. If successful, you will hear two beeps. Four beeps indicate an incorrect code to confirm, reenter the code again.
- Press **Transfer** to store the new passcode.

## SET ANSWER MODE (INTERCOM)

You can receive internal calls in one of three modes ([see Answering Intercom Calls under Intercom Calls](#) for descriptions).

- While on-hook, press **Transfer** and then dial **103**.
- Dial **0** for Ringing, **1** for Auto Answer or **2** for Voice Announce.
- Press **Transfer** to store your selection.

NOTE: When your keyset is programmed for Voice Announce and you have Forward No Answer (FNA) turned on, you must answer screened transfers by pressing the **OK** button before your FNA timer expires or the call will forward.

## SET ANSWER MODE (CO)

Your incoming CO calls can be set to follow the intercom answer mode.

- While on-hook, press **Transfer** and then dial **110**.
- Dial **15** to access **AUTO ANS CO**.
- Press the **Volume Up** [+] or **Volume Down** [-] key to change status.
- Press **Transfer** to store your selection.

## AUTOMATIC HOLD

While on an outside call, pressing a line button, route button or a flashing **Call** button will automatically put your call on hold and connect you to the next call. This feature can be turned on or off at your keyset.

- With the handset on-hook, press **Transfer** and then dial **110**.
- Dial **001** to turn Automatic Hold on or **000** to turn it off.
- Press **Transfer** to store your selection.

## HEADSET OPERATION

Keyset users can switch between headset mode and handset mode. When using headset mode, press the **Speaker** button to answer and **Speaker** button to release calls.

- With the handset on-hook, press **Transfer** and then dial **110**.
- Dial **021** to use the headset or **020** to use the handset.
- Press **Transfer** to store your selection.

Your keyset is equipped with a **Headset** button. Pressing this button while the indicator is off will cause the keyset to enter headset mode and the button indica-

tor to be lit solid to indicate this. Pressing the button while the button indicator is lit solid will cause the keyset to return to handset mode and the button indicator will go off.

NOTE: If you need to switch between headset mode and handset mode (or speaker phone) during a conversation, you will need to put the call on hold first.

## HOT KEYPAD

On your phone system your keyset's keypad can be made "live" or "hot" so that it is not necessary to lift the handset or press the **Speaker** button before you begin dialing. Calls can be made and features activated by simply dialing the C.O. line number, trunk group access code, intercom number or feature access code.

- With the handset on-hook, press **Transfer** and then dial **110**.
- Dial **031** to turn the Hot Keypad on or **030** to turn it off.
- Press **Transfer** to store your selection.

## KEY CONFIRMATION TONE

You can hear a short beep (confirmation tone) each time you press a button on the dial pad. This tone can be turned on or off.

- While on-hook, press **Transfer** and then dial **110**.
- Dial **040** to turn tones off or **041** to turn tones on.
- Press **Transfer** to store your selection.
- Additional ring tones can be selected from the **Menu, Phone, Sound, Keytone** option.

## REJOINING A PAGE

This feature allows you to hear the remaining portion of an ongoing internal page after you return your keyset to idle. To enable this feature:

- With the handset on-hook, press **Transfer** and then dial **110**.
- Dial **051** to turn this feature on or **050** to turn it off.
- Press **Transfer** to store your selection.
- —OR—
- Press the **Menu** button, scroll to **Phone**, press **OK**.
- Scroll to **Sound** and press **OK**, scroll to **Keytone**, and press **OK**.
- Using the **Navigation** button scroll to **Select New Ring Tone**, press **Save** soft button.

## RING PREFERENCE

This feature automatically answers ringing calls when you lift the handset or press the **Speaker** button. This method will always answer calls in the order they arrived at your keyset. When you turn ring preference off, you must press the flashing button to answer a call, allowing you to answer calls in the order you choose.

- With the handset on-hook, press **Transfer** and then dial **110**.
- Dial **061** to turn ring preference on or **060** to turn it off.
- Press **Transfer** to store your selection.

## DISPLAY SPEED DIAL NAME

This option allows you to view the name associated with a speed dial number as it is dialed.

- With you handset on-hook, press **Transfer** and then dial **110**.
- Press **111** to turn **DISP SPDNAME** on or **110** to turn it off.
- Press **Transfer** to store your selection.

## CALLER ID REVIEW ALL

This feature allows display keyset users to review Caller ID information for calls sent to their stations. This list can be from ten to fifty calls in a first in, first out basis. The list includes calls that you answered and calls that rang your station but that you did not answer. When reviewing this list, you can press one button to dial the person back. The system must be using LCR to dial the stored number.

- With you handset on-hook, press **Transfer** and then dial **110**.
- Press **121** to turn **CID REVIEW ALL** on or **120** to turn it off.
- Press **Transfer** to store your selection.

## SECURE OHVA

This option allows you to receive OHVA (Over Head Voice Announce) calls via the speaker while you are on the handset.

- With your handset on hook, press **Transfer** and then dial **110**.
- Press **131** to turn **SECURE OHVA ON** or **130** to turn it **OFF**.
- Press **Transfer** to save your selection.

## CONFIGURE MOBILE EXTENSIONS (MOBEX)

This feature allows you to configure options for any Mobile Extension (MOBEX) ports that are assigned to you by your telephone system administrator. You can turn a port on or off; set the telephone number for the port; or set the caller ID you will be calling in from. The caller ID field has no effect unless you have been author-

ized as an Executive MOBEX user. Check with your telephone system administrator for further details on your specific system configuration.

### To set the phone number a MOBEX port can reach you on:

- Press **Transfer** and then dial **126**.
- Dial your station pass code.
- Dial the number of the port you wish to configure (1-5) (you may also use the **Volume Up** [+] or **Volume Down** [-] keys to select a port and press the **Right** soft key to confirm).
- Press **Right** soft button to move to telephone number.
- Dial the number of a C.O. line or trunk group to use when making calls to this MOBEX port.
- Dial the phone number you can be reached at by users calling this MOBEX port.
- Press **Transfer** to store your selection and exit programming.

### To set the caller ID of the location you will be calling in from:

- Press **Transfer** and then dial **126**.
- Dial your station pass code.
- Dial the number of the port you wish to configure (1-5) (you may also use the **Volume Up** [+] or **Volume Down** [-] keys to select a port and press the right soft key to confirm).
- Press **Right** soft button twice.
- Dial the contact number.
- Press **Transfer** to store your selection and exit programming.

### To turn a MOBEX port ON or OFF:

- Press **Transfer** and then dial **126**.
- Dial your station pass code.
- Dial the number of the port you wish to configure (1-5) (you may also use the Volume Up and Volume Down keys to select a port and press the **Right** soft key to confirm).
- Dial **2** to select the activation status option.
- Dial **0** to turn the port on, dial **1** to turn the port off.
- Press **Transfer** to store your selection and exit programming.

# DISPLAY FEATURES

## DIRECTORY INFORMATION

An 11 character directory name can be assigned to each extension number. Display keyset users can view the name of the called or calling station before answering.

Each outside line can have an 11 character directory name. Incoming calls can be easily identified and answered with different greetings.

Outside and internal calls ringing to a station group will display [CALL FOR xxx] where xxx is the station group number. This allows you to answer calls directed to you differently than calls directed to your group.

## DISPLAY NUMBER DIALED

Display keysets begin showing digits as they are dialed. They will stay in the display until the call duration timer comes on automatically or the **Timer** button is pressed. If the call duration timer is not used, the number dialed will be displayed until the call is released, transferred or put on hold.

## CALL DURATION TIMER

The system can be set to automatically time outside calls. A few seconds after you dial a telephone number, the timer appears in the display. It appears immediately for incoming calls. The call timer continues for the duration of the call. Call duration times are displayed in minutes and seconds. If a call lasts longer than 60 minutes, the timer restarts.

You can press the **Timer** button to manually begin timing a call. Press it again to stop timing. If you press it while the automatic timer is on, the call duration time is restarted.

## AUTO TIMER

Display keyset users may have the timer automatically start when they answer incoming calls or after a short delay on an outgoing call.

- With the handset on-hook, press **Transfer** and then dial **119**.
- Dial **41** to turn the auto timer on or **40** to turn it off.
- Press **Transfer** to store your selection.

## TIMER FUNCTION

Display keyset users may use this feature as a simple stopwatch.

- When the keyset is idle, press the **Timer** button to start timing.
- Press the **Timer** button again to stop timing.
- Read the elapsed time in the display.
- Lift the handset and replace it. The display will return to date and time.

## VIEWING STATION MESSAGE INDICATIONS

You can view all of your message indications before you return them:

- With the handset on-hook, press the **Message** button with the flashing indicator.
- The first station that left a message indication will be displayed.
- Press the **Volume Up** [+] or **Volume Down** [-] keys to scroll through the stations that left message indications. Use the soft keys to reply, clear or advance to the next message.
- Press the **End** button to return your keyset to the idle condition.

## PERSONAL SPEED DIAL NAMES

Each personal speed dial number can have an 11 character name assigned to it. This name is used to select the speed dial bin when you are dialing by directory.

- Press **Transfer** and then dial **106**.
- Dial the speed dial bin number **00–49**.
- Using the dial pad, enter the station name. ([See Station Names](#))
- Press the **Transfer** button to store the speed dial name.
- Repeat for each speed dial bin if necessary.

NOTE: Use the Navigation button to move the cursor left or right, and use the **Volume Up** [+] or **Volume Down** [-] buttons to increment the speed dial bins.

[See Programming Personal Speed Dial Numbers Section.](#)

## STATION NAMES

- With the handset on-hook, press **Transfer** and then dial **104**.
- Enter the **Station Name**. Use the **Volume Up** [+] or **Volume Down** [-] buttons to move cursor.
- Press **Transfer** to store the name.  
—OR—
- Press **Menu** button, select **Settings**, press **OK**.
- Select **Application Set.**, press **OK**.
- Select **Phone Name**, press **OK**.

- Enter **Station Name**. Use the **Volume Up** [+] or **Volume Down** [-] buttons to move cursor.
- Press **Save** soft button and then **End** soft button to store the name.

## MANAGING PROGRAMMABLE KEY ASSIGNMENTS

You can manage your key assignments for easy one touch operation of frequently used features.

- While on-hook, press **Transfer** and then dial **107**.
- Use the **Volume Up** [+] or **Volume Down** [-] buttons to scroll through all of your programmable buttons.
- Press **Transfer** to exit programming.

To program the programmable keys, press **Menu, Settings, AOM Setting**.

For example:

**If you want to press a key that will direct calls to Joel at extension 3201.** Select an empty key and set the following:

- Feature: DSS
- Ext. Number: 3201
- Display Name: Joel

**If you want to press a key that will direct calls to Sue's external phone number at 972-444-3456.** Select an empty key and set the following:

- Feature: Speed
- Ext. Number: 01
- Display Name: Sue
- Use Transfer 105 to set speed dial number: [xxxx] SPEED DIAL  
01: 9-9724443456

Please consult your installation company to requested a complete list of descriptions for any keys you may have programmed on your keyset.

NOTE: Confirm that the cursor is placed correctly before you enter the extender.

## BACKSPACE WITH LCR

If you misdial while using LCR, you can delete digits shown in the display by pressing the **Backspace** soft key as many times as necessary or by pressing **Clear** to delete all.

ing the **Del** soft key as many times as necessary.

# CALLER ID

## SELECTING YOUR CALLER ID DISPLAY

Simultaneous display of Caller ID name and number on incoming CO calls on both lines of display keysets is supported on all OfficeServ systems. On Transferred CO calls, you can decide if you want to see the Caller ID name or Caller ID number in the display. Regardless of which data is selected, you can press the NND button to view the other pieces of Caller ID information. To select the type of Caller ID information you wish to view:

- With the handset on-hook, press **Transfer** and then dial **119**.
- To set the first line of a ringing call display dial **0**.
- To set the second line of a ringing call display dial **1**. Set the data to display from the following:
  - To show nothing dial **0**.
  - To show Caller ID Number dial **1**.
  - To show Caller ID Name dial **2**.
  - To show the DID Number the call came in on dial **3**.
  - To show the Name of the DID the call came in on dial **4**.
  - To show the Name of the Group the call came in for dial **5**.
  - To show the DID Number and then Name of the DID dial **6**.
  - To show the Name of the DID and then the DID Number dial **7**.
- To set the top line of the display shown after answering a call dial **2**. Set the data to display from the following:
  - To show Caller ID Number dial **0**.
  - To show Caller ID Name dial **1**.
  - To show the DID Number the call came in on dial **2**.
  - To show the Name of the DID the call came in on dial **3**.
  - To show Caller ID Number and then the DID Number dial **4**.
  - To show Caller ID Name and then the DID Number dial **5**.
  - To show the DID Number and then the name of the DID dial **6**.
  - To show the Name of the DID and then the DID Number dial **7**.
  - To show the C.O. line information dial **8**.
- To set the format if the C.O. line information when the above is set to show C.O. line information dial **3**.
  - To show the C.O. line number and the dialed or Caller ID Number dial **0**.
  - To show only the dialed or Caller ID Number dial **1**.
- Press **Transfer** to exit and store your selection.

## VIEWING THE NEXT CALLER ID CALL

In the event that you have a call waiting or a camped-on call at your keyset, you can press the **Next** button to display the Caller ID information associated with the call in queue at your keyset. Either the CID name or CID number will show in the display depending on you Name/Number selection.

To view Caller ID information for calls that have been camped-on to your keyset, press the **Next** button.

## INQUIRE CALLER ID PARK/HOLD INFO

If you are informed that an incoming call is on hold or has been parked for you, you may view the Caller ID information before you retrieve the call. This may influence how you choose to handle the call.

### From an idle keyset:

- Press the **Inquire** button—**OR**—press **CID** button, then **Func.** soft button, and the **Inquire** soft key.
- Dial the trunk number.
- You may now answer the call by pressing the **ANS** button—**OR**—you may use **Func.** soft button and **NND** to view more information about this call—**OR**—you can return to the idle condition by pressing **Ignore**.

### If you are on a call:

- Press the **Func.** soft button and then **Inquire** button. Your existing call will go on hold—**OR**—press the **CID** button and **Func.** soft button then **Inquire** soft button to place the first call on hold.
- Dial the trunk number.
- You may now answer the call by pressing the **Func.** soft button then the **ANS** button—**OR**—you may use **NND** to view more information about this call—**OR**—you can return to the idle condition by pressing the **Func.** soft button and then **Ignore**.

### NOTES:

1. If you are on an intercom call or you have Automatic Hold turned off, you must finish the existing call or place it on hold before inquiring.
2. If you inquire about an outgoing call, you will receive a [call no longer available] display.

## FEATURE ACCESS CODES

### Paging Zones - Dial 55 plus

0	_____
1	_____
2	_____
3	_____
4	_____
5	_____
6	_____
7	_____
8	_____
9	All External Zones
*	All Page

### Feature Access Codes

0	Operator	56	Meet Me Answer
10 + xxx	Pick Up A Parked Call	600	Cancel All Call Forward
12 + xxx	Pick Up a Held Call	601 + xxx	Set Forward All Calls
13	Door Lock Release	602 + xxx	Set Forward Busy
16 + xxx	Speed Dialing	603 + xxx	Set Forward No Answer
17	Save And Redial Number	604 + xxx	Set Forward Busy/No Answer
18	New Call (Recall)	605 + xxx	Set Forward on DND
19	Last Number Redial	606 + xxx	Set Forward Follow Me
400	Cancel Do Not Disturb	65 + xxx	Pick Up Ringing Extension
401	Do Not Disturb	66 + xx	Pick Up Group
42 + xxx	Cancel Sent Message	67	Universal Answer
43	Return Message	*	Authorization Code
44	Callback		
45	Busy Station Camp-On		
46	Conference		
47	Account Code		
48 + xx	Cancel Programmed MSG		
49	Send Flash to C.O. or PBX		
53 + xxx + 1	In Group		
53 + xxx + 0	Out of Group		

## SECTION 6. APPLICATIONS

### Samsung Voicemail

This section describes how to setup and use the various features available to a Subscriber. A Subscriber is a person that has been authorized access to the various features and services available in the Samsung Voicemail. Please review this section carefully before you use your Authorized Features and Services, known as Subscriber Services.

Voice Mail is one of the Subscriber Services available. Your voice mail box has the capability of storing private messages, and offers a number of options for sending or redirecting messages as well as provides several ways to notify you of new messages.

Another very common Subscriber Service is Access Manager. This allows you control over when and where you receive your calls as well as what to speak to your callers in the event you are unable to speak to them directly. The 'events' are referred to as "Call Conditions". No-Answer, Busy, and Blocked are the most commonly used Call Conditions.

This guide can be used by Subscribers from within the office or from telephones outside the office. The basic operation is the same, but the access method will be different. [See the Subscriber Services Menu Diagram for more details.](#)

Note that some features and prompts detailed here may not be available to all Subscribers. See your System Administrator if you have questions about feature availability.



# Subscriber Services Menu

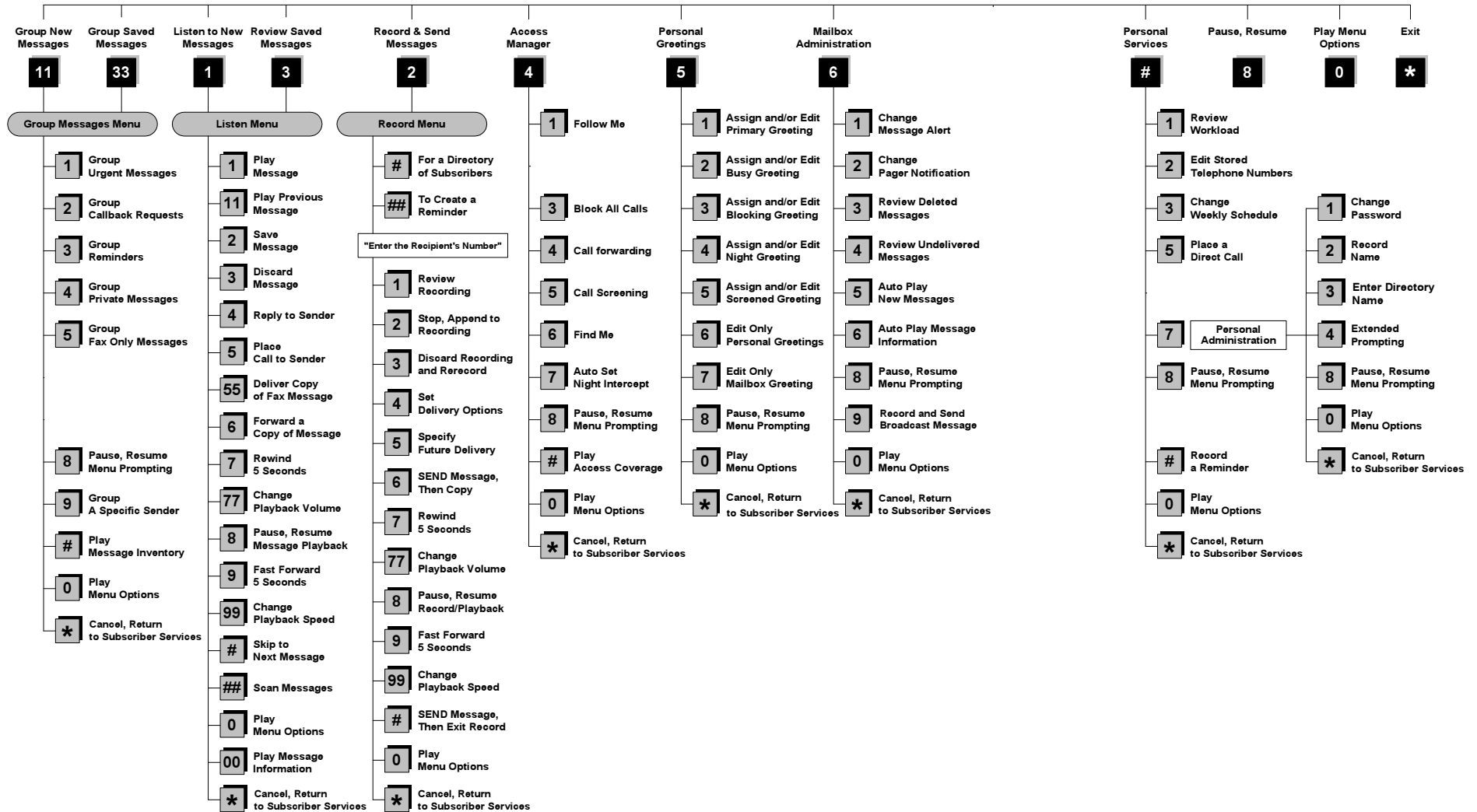

NOTE: All options shown MAY NOT be authorized. If an option is not available please speak to your system administrator.

\*Change Playback Speed and Volume not available on the OfficeServ 7030, OfficeServ 7100, OfficeServ 7200-S or OfficeServ IP-UMS.

## ACCESSING YOUR MAILBOX

*[Also known as Subscriber Services Menu]*

### Inside Callers *[Subscriber logging in from their Desk]*

- Dial the voicemail access number or press the key assigned to ring voicemail **[VMMMSG]**.
- Enter your personal password when prompted (the default password is 0000).

### Outside Callers *[Subscribers calling from Cell Phones or outside of the office environment]*

- Dial the phone number that will be answered by the voicemail. The main greeting will answer.
- At the main greeting dial **[#]** plus your Subscriber (or mailbox) number (Subscriber and Mailbox numbers will usually match your extension number).
- Enter your personal password when prompted (the default password is 0000).

### Access your Subscriber Services (or Mailbox) from a Station other than your Own (or checking a mailbox associated with a different station)

- Press the **[VMMMSG]** key or dial the voicemail **group number**. You will be prompted to enter a password.
- Press **[\*]**. This will take you to the Main Auto Attendant Menu.
- Press **[#]** plus the Subscriber number of your choice. You will be prompted to enter your password.

At this point the inside and outside callers follow the same instructions. You will hear a message stating the number of messages left in your mailbox. You will then hear the Subscriber Services Menu with the following options:

- 1 Listen to New Messages - [See Listening to your Message.](#)**
- 2 Record and Send Message - [See Sending Messages.](#)**
- 3 Review Saved Messages - [See Listening to your Message.](#)**
- 4 Access Manager - [See Access Manager.](#)**
- 5 Personal Greetings - [See Personal Greetings.](#)**
- 6 Mailbox Administration - [See Mailbox Administration.](#)**
- # Personal Services - [See Personal Services.](#)**
- \* Return to Main Menu.**

**Voicemail and the Function Soft button:** When accessing and retrieving voicemails from the mailbox, the service options such as **(1) Listening to Messages**, **(2) Record and Send Messages**, and **(3) Review Saved Messages** are available and can be accessed through the dial pad or through the **Function** soft key. When pressing the function soft button the options will be displayed. Scroll to and press the **OK** button to select an option from the **Function Menu**.

## GETTING STARTED

Using your new Samsung Voicemail Subscriber Services is as simple as following a few simple spoken instructions. First time users should read this section as a tutorial. You should start with the following steps:

- Access your Subscriber Services Menu - You already know how to do this.

### From the Subscriber Services Menu:

- Record a Primary/No-Answer Personal Greeting. Dial **[5][1]**.
- Record a Mailbox Greeting. Dial **[5][7]**.
- Change your access code (Password). Dial **#[7][1]**.
- Record your name. Dial **#[7][2]**.
- Enter your directory name. Dial **#[7][3]**.

After you have completed the steps above your Subscriber Services are set up and ready to use.

## LISTEN TO YOUR MESSAGES

If there are new messages in your mailbox your **[VMMMSG]** key will be lit. Call the Samsung Voicemail by pressing this key, and when prompted enter your password. You will then be at the Subscriber Services Menu. Select **[1]** to listen to new messages or **[3]** to listen to saved messages.

Note: After you enter your password, if "Autoplay of New Messages" is enabled and you have new messages the Samsung Voicemail will begin to play them automatically. A subscriber can control this feature. From the Subscriber Services Menu **[6][5]** toggles "Autoplay of New Messages" ON/OFF.

## SUBSCRIBER SERVICES MENU

The following is a list of all the options available in the Subscriber Main Menu.

- 1** LISTENING TO NEW MESSAGES
- 11** GROUP NEW MESSAGES
- 2** RECORD AND SEND A MESSAGE
- 3** LISTENING TO OLD MESSAGES
- 33** GROUP OLD MESSAGES
- 4** ACCESS MANAGER
- 5** PERSONAL GREETINGS
- 6** MAILBOX ADMINISTRATION
- 8** PAUSE / RESUME
- 0** PLAY MENU OPTIONS
- \*** EXIT TO AUTO ATTENDANT
- #** PERSONAL SERVICES

# 1 or 3

## LISTENING TO OLD OR NEW MESSAGES

- 1 Play / replay the message you just heard.
- 11 Play the previous message.
- 2 Save the message you just heard and listen to the next message.
- 3 Delete the message you just heard and listen to the next message.
- 4 Reply to the message.  
This will allow you to leave a message in the mailbox of the sender (if the sender has a mailbox on this system).
- 5 Return the call directly to the telephone number that left the message.  
This will work for internal and external callers, but Caller ID service is needed to use this feature on an outside call.
- 55 Deliver a fax copy.  
This will allow you to receive attached faxmail document(s). Faxmail documents can be delivered to any fax machine of your choice as long as out calling is authorized. You can also have faxmail messages automatically delivered to the fax machine of your choice.
- 6 Forward the message and saves a copy.  
The subscriber can be selected by dialing their mailbox number (nnn), using the directory service (#) or you may also add comments and leave it as a memo to yourself (##).  
The Send and Copy Service (option 6) allows a user to send copies of a message to multiple recipients easily. A different introduction message may be left for each recipient.
- 7 Rewind the message 5 seconds.
- 77 Change playback volume of the recording. **[Not available on the OS 7030, OS 7100, OS 7200-S or OS IP-UMS]**  
There are two levels of volume during playback. Dialing this code will toggle between the two levels.
- 8 Pause or resume during message playback.
- 9 Fast forward the message 5 seconds.
- 99 Change playback speed of the recording. **[Not available on OS 7030, OS 7100, OS 7200-S or OS IP-UMS]**  
There are two levels of speed during playback. Dialing this code will toggle between the two speeds.

- 0 Play options.  
Pressing this key will play all the menu options available to you from this point.
- 00 Hear the time and date, and sender's information of the message you just heard. Sender information is not available on outside calls.
- # Move to the next message. This does not Save or Discard the current message - it is retained as new.
- ## Scan. Plays first 7 seconds of a message then skips to next message. This is similar to the scan button on a radio. It will allow you to find a specific message quickly. To stop scanning press [1].
- \* Cancel and return to previous menu.

# 11 or 33

## GROUP NEW OR OLD MESSAGES

Messages can be grouped as either Reminders, press [3] or Messages from a specific sender, press [9].

Additionally you can press [#] and hear a summary of your mailbox contents:

- a) Number of messages
- b) Number of reminders
- c) Number of urgent messages
- d) Number of messages needing a callback
- e) Number of private messages
- f) Number of fax messages

# 2

## RECORD AND SEND A MESSAGE

This option is used to send a message to another subscriber. The steps are simple:

- a) Enter the recipient's mailbox number, or if this is not known enter [#] to use the system directory.
- b) Record your message at the tone. After recording the message, you will hear the Send Menu with the following functions:
  - 1 Review
  - 2 Continue Recording

- 3 Discard and Re-Record
- 4 Set Message Attributes (Delivery Options)
- 5 Schedule Future Delivery
- 6 Save and Send then Send a Copy to Someone Else
- # Save and Send the Recording

## Setting Message Attributes

If after recording a message you select **[4]** you can set up any combination of the following delivery options:

- 1 Urgent Delivery
- 2 Return Receipt Requested
- 3 Request a Call Back
- 4 Private Delivery
- 5 Reply Required
- \* Exit

## Scheduling Future Delivery

If after recording a message you select **[5]** to schedule future delivery, you will be able to set message attributes and set this message as:

- # Immediate Delivery
- 1 Next Few Hours
- 2 End of Current Business Day (based on your Availability Schedule)
- 3 Beginning of Next Business Day (based on your Availability Schedule)
- 4 A Coming Day of the Week
- 5 Specific Day / Time
- \* Exit

# 4

## ACCESS MANAGER

The Access Manager allows the subscriber to set a number of options for when, where and how, and/or if the Samsung Voicemail contacts you when a caller dials your extension number. All of the options are toggled on/off based on their current status when you access them.

**Note: ALL** Access Manager options **MUST** be individually allowed by the System Administrator for each Subscriber. They are:

### 1 Follow Me

Allows the subscriber to enter an alternate location and set how long the new destination (Designated Location) will be active. This number may be an internal or external number. This is useful if you are frequently traveling or changing the number where you can be reached.

When Follow Me is activated, the transfer will be supervised and confirmed. This means that if the call is not answered or if rejected by the Subscriber at the designated location it will be recalled to the Subscriber's mailbox.

### 3 Call Blocking

When this feature is active, callers will not be transferred to your extension, they will hear your 'blocked' greeting (if recorded) and will go directly to your mailbox if they do not select any or are not offered any other options.

### 4 Call Forwarding

Unlike Follow Me where the subscriber wants to take their calls at an alternate location this feature allows the subscriber to pass control of his calls to another Subscriber. The "Forwarded To" Subscriber will now be in control of the caller and the caller will NOT return to originating Subscriber's Mailbox. If the "Forwarded To" Subscriber does not answer the caller it will now follow whatever the "Forwarded To" Subscriber has set up for their call conditions. The Caller will hear "Forwarding to" "{Subscriber Name}" before actually being forwarded.

### 5 Call Screening

If this is turned on, the caller will be asked their name and the Samsung Voicemail will play this name to you before the transfer, giving you an option to accept or reject the call.

## 6 Find Me

Find Me, when enabled, will attempt to locate the subscriber by calling a list of preprogrammed phone numbers. The stored phone numbers are entered in 'Personal Services' [#][2] (if allowed by the Administrator). The stored telephone number list can contain up to 9 preprogrammed telephone numbers. The Find Me feature only use the first five.

## 7 Night Intercept

This feature is dependent on your weekly availability schedule, which is entered in 'Personal Services' [#][3] (if allowed by the Administrator). When Night Intercept is active the Samsung Voicemail will first ring your extension then play your primary, No Answer greeting during the day (when you are available) and will NOT ring your extension but simply play your Night greeting during the night (when you are not available).

**Note:** This does NOT use the Day and Night schedules of the phone system. It is solely controlled by the Subscriber's Availability Schedule.

## 8 Pause / Resume

### \* Exit from Access Manager

### 0 Play All Options

### # Play Access Coverage

This feature is useful for finding out how you current access settings are set. It will also tell you what greetings will play under each of the call conditions you have setup.

# 5

## PERSONAL GREETINGS

The options available in this menu will be determined by your System Administrator, and not all of them may be available to you. In the simplest systems, only a mailbox greeting will be available, additional greetings may be accessible in more complex systems.

Your Personal Greeting will be played every time someone dials your extension and you do not answer.

You may record up to 9 Personal Greetings, and you may assign any one of them to be active. There are several different 'Call Coverage' conditions to which you may assign any of your 9 greetings. The Call Coverage Conditions are: No-Answer, Busy, and Do Not Disturb (or Forwarded All). This will allow different greetings to play depending on the type of call forward that you have set, or the condition of your telephone.

The Call Coverage conditions that you can assign specific greetings to are selected by the following digits:

### 1 Primary/No Answer Greeting

Used when in your office, away from your desk or during the time period you are scheduled available. If this is the only Personal Greeting you record, it will play for all call coverage conditions.

This option is available only if the Administrator has assigned you the 'Basic Greeting' feature.

Example: "Hi this is John Smith. I'm sorry I am not available to answer your call. If someone else can help you, please enter the extension number now. Or, to leave me a message, press 1."

### 2 Busy Greeting

Played to a caller when you are already talking to someone on your extension or the telephone at your Designated Location.

This option is available only if the Administrator has assigned you the 'Busy Greeting' feature.

Example: "Hi, this is John Smith. I'm on another line right now. If someone else can help you, please enter the extension number now. Or, to leave a message, press 1."

### 3 Call Blocking Greeting

Used while Call Blocking is enabled in your Access Manager or if your phone is forwarded ALL or DND.

This option is available only if the Administrator has assigned you the 'Call Blocking' feature.

Example: "Hi, this is John Smith. Sorry I missed your call, but I'm going to be out of the office for the next few hours. If someone else can help you, please enter the extension number now. Or, to leave me a message, press 1."

### 4 Night Greeting

Used during the time period you are scheduled UNAVAILABLE, usually after business hours during the evening and at night.

This option is available only if the Administrator has assigned you the 'Scheduling' feature.

Example: "Hi, this is John Smith. I've left the office for the evening. If you would like to try someone else, please enter the extension number now. Or, to leave me a message, press 1."

## 5 Call Screening Greeting

Used while Call Screening is enabled, and you REJECT a caller after listening to the caller's record name.

This option is available only if the Administrator has assigned you the 'Call Screening' feature.

Example: "Hi, this is John Smith. I'm sorry, but I am not available to speak with you at this time. If someone else can help you, please enter the extension number now. Or, to leave me a message, press 1."

## 6 Edit Personal Greetings

You may also edit/record each one of the greetings (1-9) at any time.

Select a greeting number to edit and follow the instructions to record your greeting. When you are done recording your greeting, you will be able to listen to the greeting you recorded, save the greeting you recorded and return to the previous menu, record the greeting again, or exit without saving the greeting.

Note: If you record only the greeting assigned to the No-Answer Call Coverage Condition, then that greeting will play to callers for all Call Coverage Conditions (No-Answer, Busy, Blocked, Night, and Rejected Caller). In this case, the salutation part of the greeting should be very general.

## 7 Edit Mailbox Greeting

Used whenever a caller reaches your mailbox or if you have not recorded any of the Call Coverage greetings. The way a caller is transferred to your mailbox greeting directly, is by another subscriber transferring the caller to your mailbox using the VT (VoiceMail Transfer) key.

This option is available only if the Administrator has assigned you the 'Mailbox Greeting Option' feature.

Example: "Hi, this is John Smith. Please leave me a message, I will call you as soon as I can."

Note: This greeting will only play if none of the 5 personal greetings has played to the caller. A common usage for this Greeting is when another Subscriber is talking with a caller and uses the VT key on their phone to transfer the caller directly to your Mailbox.

# 6

## MAILBOX ADMINISTRATION

The Mailbox Administration menu is used to turn on and off your pager notification, message alert options and other message control features.

### 1 Message Alert

When this function is activated, the Samsung Voicemail will call any outside or inside telephone number, after each message is left in your voice mailbox.

To hear your message at the remote location when the Samsung Voicemail calls you, after you pick up the telephone and answer you will be instructed that there is a message and to enter your password. Simply enter your password and you will now be logged in.

#### Setting Up Message Alert:

- From the Subscriber Services Menu press **[6]** for Mailbox Administration.
- Press **[1]** for Message Alert.
- There are 4 options available to you:
  - Press **[1]** to toggle message alert on and off.
  - Press **[2]** to set the schedule when you would like to be notified.
  - Press **[3]** to be notified on urgent messages only.
  - Press **[4]** to set the destination phone number.

### 2 Pager Notification

When this function is activated, the Samsung Voicemail will call your beeper service and notify you after each message is left in your voice mailbox.

- From the Subscriber Services Menu press **[6]** for Mailbox Administration.
- Press **[2]** for pager notification.
- There are 4 options available to you:
  - Press **[1]** to toggle pager notification on and off.
  - Press **[2]** to set the schedule when you would like to be paged.
  - Press **[3]** to be notified on urgent messages only.
  - Press **[4]** to set the pager phone number.

### 3 Undelete

When this function is activated, the Samsung Voicemail will allow you to undelete any messages that you have recently deleted (up to the programmed Daily Maintenance Time, which is set to 3 a.m. by Default the following morning).

- From the Subscriber Services Menu press **[6]** for Mailbox Administration.
- Press **[3]** for Deleted Messages.

Deleted voice mail messages are temporarily stored in memory until 3 a.m. the following day. Select this option to recover ("undelete") previously deleted messages, during this period of time.

### 4 Undelivered Retrieval

When this function is activated, the Samsung Voicemail will allow you to recall any messages you have sent that have NOT yet been picked up by the recipient.

- From the Subscriber Services Menu press **[6]** for Mailbox Administration.
- Press **[4]** for Undelivered Messages.

This useful feature will allow you to cancel any messages that have NOT yet been picked up by the recipient.

### 5 Auto Play New Messages

If this option is enabled, after you enter your password correctly any new messages will immediately begin to play. To enable (or if already enabled toggle and disable) this feature:

- From the Subscriber Services Menu press **[6]** for Mailbox Administration.
- Press **[5]** to Set Auto Play of New Messages.

### 6 Auto Play Message Information

If this option is enabled, the date, time and sender's name will be played automatically before each message. If this is disabled, the information must be requested manually by pressing '00'. To enable (or if already enabled toggle and disable) this feature:

- From the Subscriber Services Menu press **[6]** for Mailbox Administration.
- Press **[6]** to Set Auto Play of Message Information.

## 9

## MESSAGE BROADCAST

This option will only be available if it has been allowed by the System Administrator.

### Broadcast to All Mailboxes

If you have been designated as a Subscriber Administrator, you may send a message to ALL mailboxes in the system.

- From the Subscriber Services Menu press **[6]** for Mailbox Administration.
- Press **[9]** for Broadcast Messages.

This option will only be available if your mailbox has been assigned Subscriber Administration privileges.

## #

## PERSONAL SERVICES

The Personal Administration Menu is used to set your password and record your name. Many of these features must be allowed by the System Administrator.

### 1 Workload Management

Allows you to access to all reminders, both Active and Pending. If authorized you can group your reminders as Commitments, Follow-Ups or Tasks for better organization. The system will flag each reminder as Active or Pending (pending means scheduled for future delivery).

### 2 Stored Numbers

Allows you to enter up to 9 stored phone numbers. The first five of these are used in the 'Find Me' feature, but any of them (1-9) can be easily dialed using only one digit followed by the pound key, to be used by many other features from within your subscriber space. (ie: "Follow Me," "Message Alert," "Pager Alert," and "Direct Call").

### 3 Schedule Availability

Allows you to enter a weekly availability schedule for use with Night Personal Greeting and the Auto Night Intercept feature. Follow the spoken directions

to enter the days of the week and times you are generally available to talk to your callers. All other times you will be considered unavailable.

## 5 Place a Direct Call

Allows you to place a direct call out of the Samsung Voicemail from anywhere. You may either dial the number or dial a single digit 1-5 that corresponds to a stored number ([See Personal Services, 2 - Stored Numbers](#)). This feature must be authorized by the System Administrator and can be limited or opened to internal, local, and long distance calls.

## 7 Personal Administration

This area is used during the initial set up of your Subscriber Settings ([see next section](#)).

# PERSONAL ADMINISTRATION SETTINGS

This menu allows you to make changes to basic setup settings, that are rarely changed. Use these when you initially set up your personal Subscriber settings. You probably will not need to change them after that.

### 1 Setting your Password

- From the Subscriber Services Menu press **[#][7][1]**.
- The current password will be played and you will have the chance to change it.

### 2 Recording your Name

Use this option to record your name. Your recorded name is played in several different situations. It is important to record your name for proper operation of the Samsung Voicemail system.

- From the Subscriber Services Menu press **[#][7][2]**.
- The current name will be played and you will have the chance to change it.

Note: It is possible that if you do not record your name and/or enter your Directory Name (described below), you will not be included in the Dial by Name Directory.

### 3 Entering your Directory Name

Use this option to enter your Directory Name. Your Directory Name is used by callers to find you if they do not know your extension number.

- From the Subscriber Services Menu press **[#][7][3]**.

- The current Directory Name will be played as a string of digits that are equal to your name spelled out on your telephone keypad. Follow the instructions to enter a new name. You will be prompted to enter your last name and then your first name.

This must be done in order for the directory feature to work correctly.

Note: It is possible that if you do not record your name (described above) and/or enter your Directory Name, you will not be included in the Dial by Name Directory.

## 4 Extended Prompting

Use this option to drastically reduce the number of prompts played in the subscriber interface (mailbox prompts). Change this setting only if you are very familiar with the user operation of the SVMi E-Series.

Note: Remember if you know what digits to press, you can enter them at any time you do not have to wait to be prompted. This feature can be toggled on/off at anytime. Also if it is off you will be prompted within each subscriber menu to press zero for more options. This enables you to still be able to find out what to do if you were to get lost and extended prompting was disabled.

# KEYSET USER FEATURES

The following options are available if you have a display keyset. They require setup by the System Administrator.

## Message Waiting Lights

When new messages are left in your mailbox, the voice mail message light on your keyset will flash. Press this flashing key **[VMMMSG]** and follow the prompts to retrieve messages. This key may be pressed at any time to log into your Subscriber Main Menu.

## Answer Machine Emulation

If you have an Answer Machine Emulation key programmed on your keyset, you can use it to monitor calls going to your voice mail, and optionally answer them. The operation of this feature is similar to screening a call on a home answering machine.

Your keyset must be set to forward on no answer to voice mail. After ringing your station the caller will be connected to your voice mail and hear your personal greeting before leaving a message. During this time you will be monitoring the connection between the caller and your voice mail box. At this time you will only be monitoring the call, you can not talk to the other party until you answer. You may pick up the call at any time or ignore it.



To activate this feature press the **AME** button. The associated indicator will be lit steady. Press again to turn off. If this key is pressed while a station is ringing (during forward no answer), the feature will be turned on for the current call only.

While the caller is leaving a message or ringing you may:

- Press **[#]** to immediately put the caller in your voice mailbox and monitor it.
- Press **[\*]** to immediately disconnect your station. The caller continues to leave a message normally.
- Pick up the handset and monitor privately.
- Press **ANS / RLS** to answer the call (using the handset or speaker).

## AME Password

If your keyset has **AME PASSWORD** (MMC 110) set to **YES**, you must enter your station password to listen to messages being left. This will prevent unauthorized people from listening to messages being left for you.

If the password option is turned on, while a message is being left, press the flashing **AME** indicator and enter your station password (not your SVMi E-Series password). You will then hear the message being left.

## Call Record

If you have a call record button assigned to your phone, you may press it at any time, to record the conversation in progress. If you have a display keyset, you will also have the soft key options to pause and time the message.

## SHORTCUTS

### Calling

Calling a station that is busy or does not answer you can press **[#]** to immediately send the call to the called parties mailbox.

### Call Divert to Voicemail

While receiving an incoming (ringing) call, dial **[\*]** to immediately send the caller to your personal voicemail box. This will override the call forward no answer setting.

### Direct Messaging

**[#] + DSS** To make it easy to leave messages for others in your office without having to dial their extension number first, keyset users may simply dial **[#]** plus a mailbox (extension) number and leave a message directly. If you dial a busy extension press **[#]** to connect directly with the mailbox.

### Self Memo (Reminder)

Pressing **[##]** will leave a message in your own mailbox. This is useful to remind yourself of things to do now or in the future. Messages can be sent with future delivery so you can have the system call you when items become due.

## INTERACTIVE DISPLAYS

Display keyset users have the added advantage of using the soft keys and displays to play, save, delete, reply, call, forward, rewind, pause, fast forward, change the volume, get message information, or help.

### Viewing Mailbox Contents

If you have new messages, in addition to the Telephone Status Indicator (TSI) you will be able to use the keyset displays and soft keys to communicate with the SVMi E-Series.

## E-MAIL GATEWAY (EMG)

The E-Mail Gateway feature integrates your voice mail box with your email client. No matter what email client software you are using or where you use it, you can send voice mail messages and fax mail messages to your E-Mail inbox.

There are two parts to the E-Mail Gateway; E-Message Delivery and E-Message Notification.

1. **E-MESSAGE DELIVERY:** Voice mail messages (.wav) and/or fax mail messages (.tiff) are "delivered" to your Inbox with the appropriate attached file.
2. **E-MESSAGE NOTIFICATION:** You will receive an e-mail, with NO attachments, notifying you that you have a voice and/or fax mail message in your Voice Mail Box.
  - As a subscriber you can use either E-Message Delivery and/or E-Message Notification.
  - As a subscriber you can have multiple e-mail addresses. (a maximum of 5 valid email addresses).
  - E-Message Notification can be set to one e-mail address while E-Message Delivery is set to different e-mail address.

## Functionality

- With either type of EMG, when Caller ID (CID) is provided, the callers telephone number will appear in the subject field of the email along with the date and time stamp of when the voice message was originally recorded in your Voice Mail Box.
- If the caller is also a subscriber on the system and the E-Mail Gateway is set up with a valid "Reply To" address, the Subscriber's name will also appear in the "From" field. Otherwise, the "From" field will display the name of the Samsung voice mail system (SVMi-8E, SVMi-16E, or SVMi-20E) sending the message.
- Client will use their PC's Multi-Media kit (equipped with either speakers and/or a headset) to listen to messages delivered to their e-mail Inbox.

**IMPORTANT NOTE:** If the PC/Laptop/PDA/Smart Phone/etc... is not equipped with hardware and software capable of playing a '.WAV' file then the E-Mail Gateway will not work for them until they add some method to listen to '.WAV' files delivered to their Inbox.

The same applies to Fax Mail messages, if the device the subscriber is using does not support the viewing of '.TIFF' files, then the E-Mail Gateway for Fax Mail will not work for them until they add some method to view .tiff files delivered to their inbox.

- No Synchronization of messages is performed between the Voice Mail Box and the E-mail Inbox.
  - Messages listened to, forwarded, deleted, and/or saved within an e-mail inbox will NOT effect the status of that same new message in the Voice Mail or the MWI (Message Waiting Indicator) associated with that message on the phone.
  - Also messages listened to in the Voice Mail, from a phone, will not change the Unread/Read status of the same message in an e-mail inbox.

- However, the Voice Mail Administrator can adjust parameters per subscriber or group of subscribers that decide how, when, or if to delete the original voice message after it is sent to the E-Mail Server.

- When full synchronization of messages between Voicemail Box and E-mail Inbox is required, ask your Samsung representative about the OfficeServ IP-UMS. This is an Internet Protocol based fully synchronized Unified Messaging System.

## Benefits

- Store and Archive Voice and Fax Mail Messages in visible folders.
- Voice and Fax Mail Messages can now easily be dragged and dropped into folders the same way e-mail messages are organized and saved.
- Voice and Fax Mail Messages are now essentially the same as any other e-mail message.
- Backups and Message Archives can be made when they are made for all other types of e-mail messages.
- Add text notes and comments to use for reference later.
- Some (if not all) e-mail clients will allow you to edit the body of the e-mail to add comments.
- Some will allow you to edit the subject field to help you find a particular message quickly in a large archive of messages.
- Call Back Numbers and Date & Time Stamp are easily displayed in the Subject field.
- Easily forward Voice messages received, to others even if they are not a Voice Mail Subscriber on your system.
- No EMG System or Client Software to load on your Local PC or Network Servers.

Therefore compatible with most:

- E-Mail providers and E-Mail Clients
- PCs, Laptops, PDA, and/or Smartphones

**NOTE:** If you are not sure you have this functionality on your system and you would like to use it, please contact your on Site system administrator to see if it is available.

## PERSONAL SPEED DIAL NUMBERS

CODE	NAME	TELEPHONE NUMBER
00	_____	_____
01	_____	_____
02	_____	_____
03	_____	_____
04	_____	_____
05	_____	_____
06	_____	_____
07	_____	_____
08	_____	_____
09	_____	_____
10	_____	_____
11	_____	_____
12	_____	_____
13	_____	_____
14	_____	_____
15	_____	_____
16	_____	_____
17	_____	_____
18	_____	_____
19	_____	_____
20	_____	_____
21	_____	_____
22	_____	_____
23	_____	_____
24	_____	_____

## PERSONAL SPEED DIAL NUMBERS

CODE	NAME	TELEPHONE NUMBER
25	_____	_____
26	_____	_____
27	_____	_____
28	_____	_____
29	_____	_____
30	_____	_____
31	_____	_____
32	_____	_____
33	_____	_____
34	_____	_____
35	_____	_____
36	_____	_____
37	_____	_____
38	_____	_____
39	_____	_____
40	_____	_____
41	_____	_____
42	_____	_____
43	_____	_____
44	_____	_____
45	_____	_____
46	_____	_____
47	_____	_____
48	_____	_____
49	_____	_____

## FEATURES AND SPECIFICATIONS

### LINE GROUPS

9 Local/LCR  
 800 \_\_\_\_\_  
 801 \_\_\_\_\_  
 802 \_\_\_\_\_

### STATION GROUPS

501 \_\_\_\_\_  
 502 \_\_\_\_\_  
 503 \_\_\_\_\_  
 504 \_\_\_\_\_

### PAGING ZONES - DIAL 55 PLUS

0 \_\_\_\_\_  
 1 \_\_\_\_\_  
 2 \_\_\_\_\_  
 3 \_\_\_\_\_  
 4 \_\_\_\_\_  
 5 \_\_\_\_\_  
 6 \_\_\_\_\_  
 7 \_\_\_\_\_  
 8 \_\_\_\_\_  
 9 All External Zones  
 \*All External Zones and Internal Zone 0

### PROGRAMMED MESSAGES

01 In A Meeting  
 02 Out On a Call  
 03 Out To Lunch  
 04 Leave A Message  
 05 Page Me  
 06 Out Of Town  
 07 In Tomorrow  
 08 Return Afternoon  
 09 On Vacation  
 10 Gone Home  
 11 \_\_\_\_\_  
 12 \_\_\_\_\_  
 13 \_\_\_\_\_  
 14 \_\_\_\_\_  
 15 \_\_\_\_\_  
 16 \_\_\_\_\_  
 17 \_\_\_\_\_  
 18 \_\_\_\_\_  
 19 \_\_\_\_\_  
 20 \_\_\_\_\_

### FEATURE ACCESS CODES

10 + xxx Pick Up A Parked Call  
 12 + xxx Pick Up A Held Call  
 13 Door Lock Release  
 16 + xxx Speed Dialing  
 17 Save And Redial Number  
 18 New Call (Recall)  
 19 Last Number Redial  
 400 Cancel Do Not Disturb  
 401 Set Do Not Disturb  
 42 + xxx Cancel Message You Left  
 43 Return Message  
 44 Callback  
 45 Busy Station Camp-On  
 46 Conference  
 47 Account Code  
 48 + xx Cancel Programmed MSG  
 49 Send Flash To C.O. or PBX  
 56 Meet Me Answer  
 600 Cancel All Call Forward  
 601 + xxx Set Forward All Calls  
 602 + xxx Set Forward Busy  
 603 + xxx Set Forward No Answer  
 604 + xxx Set Fwd Busy/No Answer  
 605 + xxx Set Forward on DND  
 606 + xxx Set Forward Follow Me  
 65 + xxx Pick Up Ringing Extension  
 66 + xx Pick Up Group  
 67 Universal Answer  
 \* Authorization Code



# OfficeServ™

## SMT-i5220



USER GUIDE



# OfficeServ™ SMT-i5220

## Keypad User Guide

*For OfficeServ™ 7000 Series Systems*

# TABLE OF CONTENTS

<b><u>ABOUT THIS BOOK</u></b> .....	1
<b><u>SECTION 1. CAUTION AND PREPARATION</u></b> .....	2
<b><u>CAUTION</u></b> .....	3
<b><u>PREPARATION</u></b> .....	4
Check the Contents of the Box .....	4
Phone Installation .....	4-5
Optional Equipment .....	5
<b><u>SECTION 2. PHONE FUNCTIONS</u></b> .....	6
<b><u>SMT-i5220 LAYOUT</u></b> .....	7
Names and Functions .....	7
<b><u>KEY FUNCTIONS</u></b> .....	9
Telephone Status Indicator .....	9
Screen Structure .....	9
Text Input Method .....	10
Description of Icons .....	11
Navigating the Menus.....	12
Navigation Button and Select Switch for FWD/DND/ABSENT MSG.....	12
<b><u>SMT-i5220 SETUP</u></b> .....	13
Initializing the SMT-i5220 .....	13
Setup Mode .....	13
Easy Install Wizard .....	14
Selecting the Static IP Option .....	14
Setting Up Hot Desking (Idle Login) .....	14
Configuration Menu Structure.....	15
<b><u>SECTION 3. FREQUENTLY USED</u></b> .....	
<b><u>FEATURE OPERATION</u></b> .....	16
<b><u>EXTENSION LOG IN &amp; OUT</u></b> .....	17
<b><u>PLACING CALLS</u></b> .....	17
<b><u>ANSWERING CALLS</u></b> .....	19
<b><u>PLACING A CALL ON HOLD</u></b> .....	19
<b><u>TRANSFERRING CALLS</u></b> .....	19

Copyright 2010 Samsung Telecommunications America.

All rights reserved. No part of this manual may be reproduced in any form or by any means—graphic, electronic or mechanical, including recording, taping, photocopying or information retrieval systems—without express written permission of the publisher of this material.

Samsung Telecommunications America reserves the right without prior notice to revise information in this guide for any reason. Samsung Telecommunications America also reserves the right without prior notice to make changes in design or components of equipment as engineering and manufacturing may warrant. Samsung Telecommunications America disclaims all liabilities for damages arising from the erroneous interpretation or use of information presented in this guide.

<b>TRANSFERRING WITH CAMP-ON</b>	20
<b>CALL WAITING</b>	20
<b>CONFERENCE CALLS</b>	20
<b>FORWARDING CALLS</b>	21
<b>OTHER FEATURES AND FUNCTIONS</b>	21-24
<b>SECTION 4. PHONE FEATURES</b>	25
<b>BASIC MENUS</b>	26
Soft Button Structure	26
Menu Soft Button	26-35
Func. Soft Button	36
AOM Soft Button	36
<b>SECTION 5. OFFICESERV 7000 SYSTEM FEATURES</b>	37
<b>OUTSIDE CALLS</b>	38
Making Calls from AOM	38
Universal Answer	38
Recall Dial Tone	38
Sending a Flash	38
Busy Line Queuing with Callback	38
Busy Station Callback	39
Canceling Callback	39
Busy Station Camp-On	39-40
<b>INTERCOM CALLS</b>	41
Voice Announce Mode	41
Auto Answer Mode	41
Calling your System Operator	41
<b>CALL PROCESSING</b>	42
System Hold	42
Exclusive Hold	42
Remote Hold	42
Hold Recall	43
Consultation Hold	43
Retrieving Calls Held at Another Station	43
Call Transfer	44
Transfer with Camp-On	44
Transfer to Voice Mail	45
Call Waiting	45
Call Forward Options	45
Station Call Pickup	46

Group Call Pickup	47
My Group Pickup	47
Privacy Release	47
<b>DIALING FEATURES</b>	48
Speed Dialing	48
Programming Personal Speed Dial Numbers	49
Directory Dialing	49
Last Number Redial	50
Save Number with Redial	50
Automatic Redial/Retry	50
Pulse to Tone Changeover	50
<b>PAGING AND MESSAGING</b>	51
Making and Internal Page	51
Making an External Page	51
All Page	51
Meet Me Page	52
Call Park and Page	52
Messages—Set and Cancel	53-54
Returning Messages	54
Programmed Messages	54
<b>CONVENIENCE FEATURES</b>	55
Logging In and Out	55
Do Not Disturb	55
One Time DND	55
Mute	56
Background Music	56
Established Call Pick-Up	56
Door Phone Calls	56-57
Executive/Secretary	57
Group Listening	58
Account Codes	58
Locking Your Keypad	59
Manual Signalling	59
Off-Hook Voice Announce	60
OHVA Block	60
OHVA Reject	60
In Group/Out of Group	61
<b>CUSTOMIZING YOUR KEYSSET</b>	62
AME Password	62
Auto Camp-On	62
Select Ring Tone	62
Change Your Passcode	62

Set Answer Mode (Intercom) .....	63
Set Answer Mode (CO) .....	63
Automatic Hold .....	63
Headset Operation .....	63
Hot Keypad .....	64
Key Confirmation Tone .....	64
Rejoining a Page .....	64
Ring Preference .....	65
Display Speed Dial Name .....	65
Caller ID Review All .....	65
Secure OHVA .....	65
Configure Mobile Extensions (MOBEX) .....	65-66

Message Broadcast .....	88
Personal Services .....	88
Personal Administration Settings .....	89
Keypad User Features .....	90
Shortcuts .....	92
Interactive Displays .....	92
E-Mail Gateway (EMG) .....	92-94

**PERSONAL SPEED DIAL NUMBERS.....95-96**

**DISPLAY FEATURES .....**67

Directory Information .....	67
Display Number Dialed .....	67
Call Duration Timer .....	67
Auto Timer .....	67
Timer Function .....	68
Viewing Station Message Indications .....	68
Personal Speed Dial Names .....	68
Station Names .....	68
Managing Programmable Key Assignments .....	69
Backspace with LCR .....	69

**CALLER ID.....**70

Selecting Your Caller ID Display .....	70
Viewing the Next Caller ID Call .....	71
Inquire Caller ID Park/Hold Info .....	71

**FEATURE ACCESS CODES .....**72

**SECTION 6. APPLICATIONS .....**73

**SAMSUNG VOICEMAIL .....**74

Accessing Your Mailbox .....	75
SVMi E-Series Subscriber Services Menu Diagram .....	76-77
Getting Started .....	78
Listen to your Messages .....	78
Subscriber Services Menu .....	78
Listening to Old or New Messages .....	79
Group New or Old Messages .....	80
Record and Send a Message .....	80
Access Manager .....	82
Personal Greetings .....	83
Mailbox Administration .....	86



## ABOUT THIS BOOK

The new Samsung Multimedia Telephone SMT-i5220 keyset is part of the OfficeServ 7000 Series.

The SMT-i5220 keyset represents a new concept of Internet phone, in that it uses an IP address to Send/Receive voice and data. For voice communications, the SMT-i5220 uses the data network line already in place in most offices and increasing number of homes.

This guide contains 6 sections: Section 1. Caution and Preparation, Section 2. Phone Functions, Section 3. Frequently Used Feature Operation, Section 4. Phone Features, Section 5. OfficeServ 7000 System Features and Section 6. Applications. Please take the time to study this guide and to become familiar with the operation of your keyset. Keep this guide handy, as you may need to look up instructions for infrequently used features.

This book is written based on factory default settings, for the feature access codes. Sometimes, due to programming requirements, these codes may be changed. If you find that a feature code does not work as described in this book, please contact your installation and service company to determine the correct code.

## CAUTION

# SECTION 1. CAUTION AND PREPARATION

- Read the installation instructions before connecting the system to its power source.
- If there is dirt or moisture on the pin contact surface of a power plug, pull out the plug and wipe it away with a cloth. If dirt or moisture remains on the product even after wiping, contact the service center.
- For the power connection port of the phone, use the supplied power adapter. (The power adapter is supplied separately.) Use of a power adapter that does not meet the specifications may cause the product to become damaged, to overheat, or to explode.
- Do not place the phone in a location with a lot of dust, in a location that is subject to severe changes in temperature, or near a heating device (cigarette heat, heater, etc.)
- Do not use or store flammable spray or materials near the phone.
- Do not place vases, flowerpots, cups, or a container of cosmetics or drugs near the phone.
- Installation of equipment must not route interconnecting cables or external power supply sources outdoors.
- The LAN cable to the network should be connected to the LAN port of a phone, NOT to the PC connection port.
- Use a soft and dry cloth when cleaning the phone. Do not spray water directly onto the product; and do not use chemicals such as wax, benzene, alcohol, thinner, mosquito killer, perfume spray, lubricant, detergent, etc.

# PREPARATION

## CHECK THE CONTENTS OF THE BOX

Check if the product package box includes all the components as follows:

- Phone body including a base
- Handset
- Handset cord
- Patch cable

**NOTE:** Power transformer sold separately. If any of these items are missing or damaged, please contact your dealer.

## PHONE INSTALLATION

### Connecting the Phone Body

Remove the base of the phone by pressing the **[Push]** mark on the top of the base.

Note: The base can be used to adjust the phone angle in the high or low position.



- 1 Connect a handset to the handset port on the back of the phone.
- 2 Disconnect the Ethernet cable from the computer, and attach it to the PC port on the back of your IP phone.
- 3 Connect the Ethernet port in your workspace to the LAN port on the back of your phone, using the provided LAN (UTP) cable. Your IP phone now shares a network connection with your computer.
- 4 Connect a standard power outlet in your workspace to the power port using the AC power adapter. The phone will subsequently boot. If your system administrator delivered your phone without a power supply, your phone probably receives power through the Ethernet connection.
- 5 To use a headset, connect the headset to the headset port on the back of your phone.

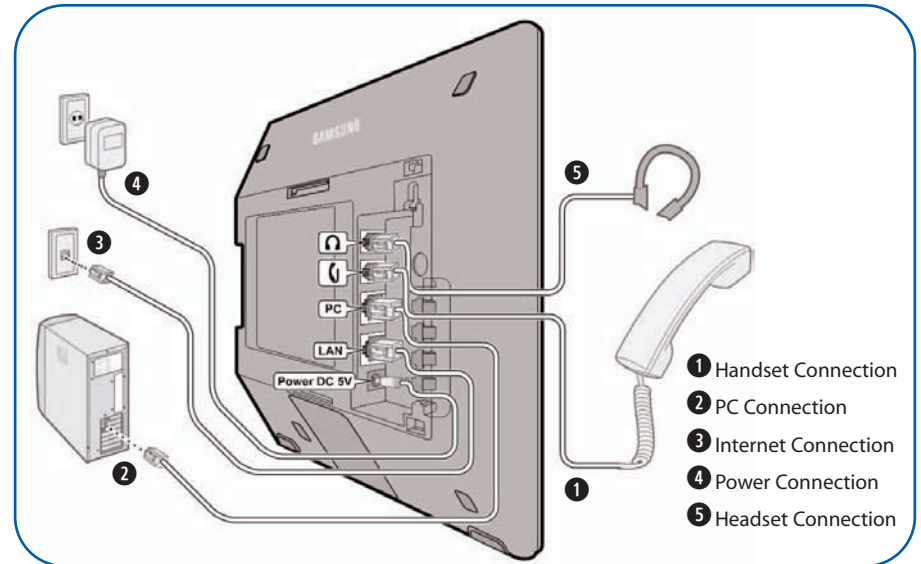

## OPTIONAL EQUIPMENT

### SMT-i5264 [ADD-ON MODULE]

The **SMT-i5264** IP AOM can be registered and programmed to function with any ITP 5100 keysets, SMT-i Series, and TDM phones. This add-on module was cosmetically designed to match the SMT-i5000 Series phones. In some applications multiple IP AOMs can be supported per IP phone. *For installation instructions, see your System Administrator.*



### SMT-A52GE [GIGABIT ADAPTER]

The **SMT-A52GE** Gigabit Adapter processes the Gigabit data for a Gigabit LAN connection on the PC connected to the SMT-i5200 IP phones. The SMT-A52GE can be installed to function with any of the SMT-i5200 Series IP phones. *For installation instructions, see your System Administrator.*



### WALL MOUNT BRACKET

An optional bracket is available for wall mounting the SMT-i5200 Series phones to the wall. *For installation instructions, see your System Administrator.*

### SMT-A53PW [POWER ADAPTER]

The power adapter is sold separately.

**CAUTION:** The input power of the SMT-i5220 needs 5.0vDC and 3000mA. The SMT-i5220 phone needs to be powered by using Samsung's SMT-A53PW power adapter. Failure to use the appropriate power supply will cause permanent damage to the phone and will void Samsung's warranty.

## SECTION 2. PHONE FUNCTIONS

# SMT-i5220 LAYOUT

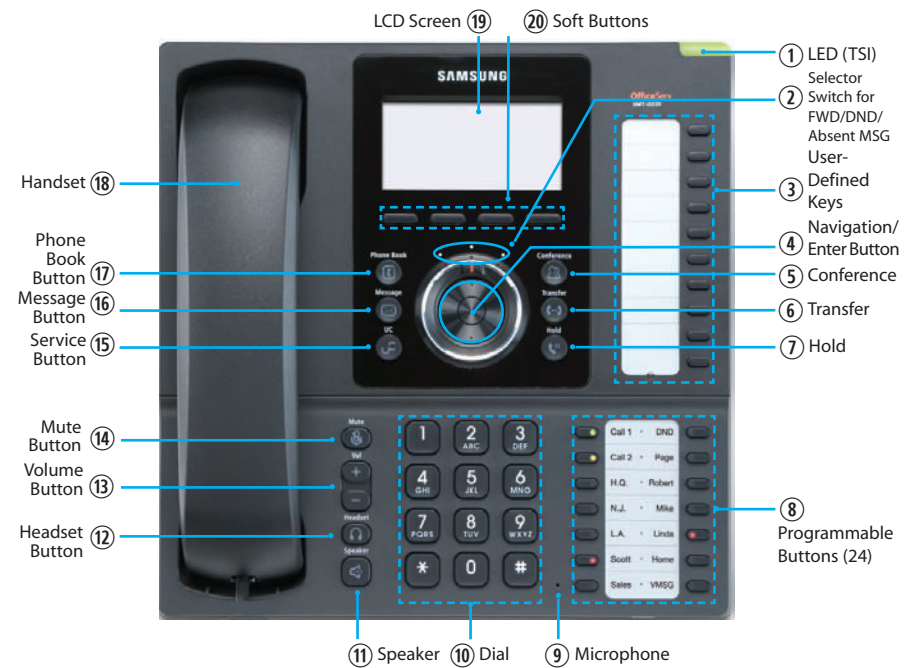

**NOTE:** The words “key” and “button” are interchangeable.

## NAMES AND FUNCTIONS

Button	Function
① LED (TSI)	The blinking pattern differs depending on the phone status (Telephone Status Indicator).
② Selector Switch for FWD/DND/Absent Message	Used to select or deselect the <b>Call Forwarding/DND/Absent Message</b> setting by using the Selector Switch control.
③ User-Defined Function Keys	Provide access to phone lines, web-based services, and phone features.
④ Navigation/ Enter Button	Used to scroll through menus and highlight items. User to enter the selected menus or items.
⑤ Conference Button	Used for conference calls.
⑥ Transfer Button	Used to enable the call transfer function.
⑦ Hold Button	Used to place a call on hold.
⑧ 24 Programmable Keys	24 Buttons used to set up function buttons through interworking with a system.

Button	Function
⑨ Microphone	Allows other callers to hear you clearly when you are speaking to them.
⑩ Dial Pad	Used to dial the phone number.
⑪ Speaker Button	Used to enable/disable the use of a speaker phone.
⑫ Headset Button	Used to activate and deactivate the headset jack.
⑬ Volume Button	Used to control the volume settings.
⑭ Mute Button	Used to silence the transmit voice to the remote party.
⑮ Service Button	For use with the Unified Communicator Server and to set Scheduler (optional).
⑯ Message Button	Used to access all the messaging options: Voicemail Messages, Station Messages, SMS, and E-Mail Messages.
⑰ Phone Book Button	Used to search for a phone number saved in the phone, or to register a new number. Pressing this button shows the main screen of the phone book. Used to move downward on various list screens.
⑱ Handset	Used for two-way voice conversation.
⑲ LCD Screen	A display showing the phone's status (busy, ringing, receiving an internal message, etc.)
⑳ Soft Buttons	Perform the functions indicated by the screen text on the bottom of the display.

## KEY FUNCTIONS

**NETWORK:** The SMT-i5220 uses VoIP communication through an already-installed data network.

**LCD SCREEN:** Various functions are displayed on the LCD screen, so you can use them conveniently by using the **Navigation** buttons on the phone.

**SHORT MESSAGE SERVICE (SMS):** You can exchange text messages using this function. This function is available on IP internal stations.

## TELEPHONE STATUS INDICATOR

The indicators are turned on or off depending on the status of relevant functions.

Screen	Status	LED Indicator
	When station is busy	Red colored indicator is constant.
	When station is receiving an incoming call	Red indicator (slow flash).
	When there is a message	
	During "Do Not Disturb"	Red indicator (fast flash).
	Incoming Trunk Call	Green colored indicator flashes.
	Hold Recalls	Green/Amber colored indicator flashes.

## SCREEN STRUCTURE

The screen consists of three areas.

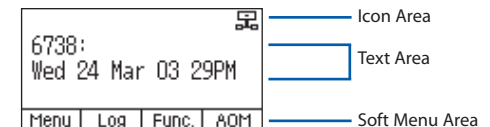

Area	Description
Icon Area	Displays various icons.
Text Area	Displays date, time, extension number, name, message, phone number, etc.
Soft Menu Area	Displays the functions allocated to the 4 soft buttons. Service menus are provided depending on the state of the phone. A user can use the service or feature menus by pressing the soft button.

## TEXT INPUT METHOD

Using the dial and direction buttons on the phone, you can enter and modify the English characters, numeric and special characters.

Whenever you press the dial button [\*] on a text input screen, the input mode is changed in sequence.

### Text Input Example

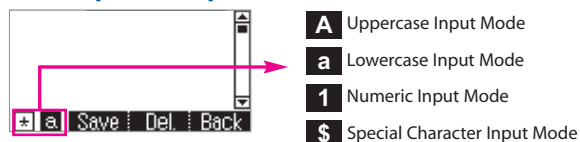

- Use the dial buttons to type English text and numbers; and use the **Navigation Button** to move the cursor left and right and **OK** buttons to complete input. When removing the typed characters, select the **Del** soft button.

**English Input:** Select this mode (uppercase/lowercase) by pressing the [\*] button, and type text by repeated pressing the dial buttons.

**Number Input:** Select this mode by pressing the [\*] button, and type numbers by pressing the dial buttons.

**Special Character Input:** Select this mode by pressing the [\*] button; select a desired character by using the **Direction Arrows** soft button; and press the **OK** button to enter it.

### Keypad Character Entry

Count	1	2	3	4
Dial *	A <small>(Uppercase)</small>	a <small>(Lowercase)</small>	1 <small>(Numbers)</small>	\$ <small>(Special Characters)</small>
Dial #	Not Used			
Dial 0	Not Used			
Dial 1	Not Used			
Dial 2	A	B	C	
Dial 3	D	E	F	
Dial 4	G	H	I	
Dial 5	J	K	L	
Dial 6	M	N	O	
Dial 7	P	Q	R	S
Dial 8	T	U	V	
Dial 9	W	X	Y	Z

## DESCRIPTION OF ICONS

The following icons are displayed on the screen.

Icon	Description
	Shows that 'Call Forward' is enabled.
	Shows that 'Do Not Disturb' is enabled.
	Shows that 'Mute' function is enabled. When the call ends to become a standby status or this function is disabled, this icon disappears.
	Shows that the call is hold state. When call is reconnect or disconnected, this icon disappears.
	Appears when there are unread <b>Short messages</b> in the message inbox. Once they are read, it disappears.
	Shows that a LAN cable is <b>connected</b> to the <b>PC port</b> .
	Shows that a <b>LAN cable</b> is connected to the LAN port but that the system is <b>not connected</b> .
	Shows that a <b>LAN cable</b> is <b>connected</b> to the LAN port and that the system is connected normally.
	<b>Outgoing</b> Call icon.
	<b>Incoming</b> Call icon.
	<b>Missed</b> Call icon.
	Appears when the <b>Speaker</b> button is active.
	Appears when the <b>Headset</b> button is active.
	Shows when there is a <b>Cell phone</b> number for the entry in the Phone Book.
	Shows when there is a <b>Home phone</b> number for the entry in the Phone Book.
	Shows when there is a <b>Office phone</b> number for the entry in the Phone Book.
	Shows when there is an internal <b>Extension</b> number for the entry in the Phone Book.

## NAVIGATING THE MENUS

When programming within various menu options, information can be entered via the dial pad keys using [0]-[9] and [\*] dial keys. The button used for editing and their features are summarized below.

BUTTONS	FEATURES
<b>Volume + and -</b>	To move the cursor left and right, up and down.
<b>Hold</b>	To clear/delete an entire field such as station name.
<b>Transfer</b>	To write the changes and exit programming.
<b>Speaker</b>	To write the changes and exit programming.

## NAVIGATION BUTTON and SELECTOR SWITCH FOR FWD/DND/ABSENT MSG

The SMT-i5220 phone has a navigation button and a Selector Switch for FWD/DND to allow users to use its functions easily.

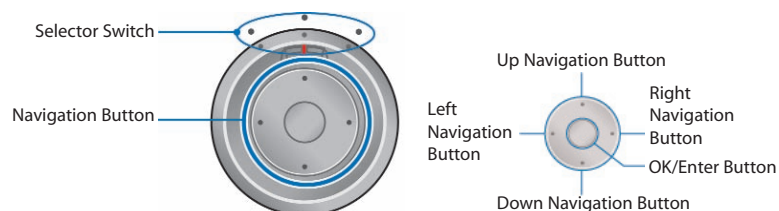

The Selector Switch can be used to manually set and cancel station Call Forwarding and Do Not Disturb. **NOTE:** Do not use the access codes or the function menu to cancel FWD/DND/ABSENT MESSAGE when the selector switch is set in the left or right position because the switch takes precedence over the access codes/function menu.

BUTTON	FUNCTION
<b>Selector Switch</b>	Left Users can set the phone to the call forward state.
	Center The default standby status. (Normal Mode)
	Right This is set to "Do Not Disturb" and absent message status.
<b>Navigation</b>	Direction Key Users can edit the contents on the screen or move between menu items.
	OK/Enter Users can select or save the item where a cursor is placed in a menu mode. Users can check the caller information received from a station line during receiving.

## SMT-i5220 SETUP

### INITIALIZING THE SMT-i5220

Initially the SMT-i5220 IP keyset will need to be setup to operate within the users network. The Setup Menu is also used to make changes to the keyset, in the event that the system information should change. The option chosen will be highlighted.

The station numbers will be automatically set by the OfficeServ 7000 Series systems once the necessary information has been entered into the IP keyset. Enter ID and password of the server, as described below to register the phone.

See your system administrator for specific Network and Server addresses. The addresses necessary to set up the SMT-i5220 are:

- IP Address of Station
- Network Gateway Address
- IP Address of System's main processor
- User ID
- Password

### SETUP MODE

To get to the **SETUP MODE** unplug the power cord from the SMT-i5220. Press and hold the \* button while you plug power back into the phone. Release the \* button when you see Samsung in the display. If you have a PoE (Power over Ethernet) connection, the same procedure can be done by unplugging and plugging the Ethernet cable into the phone while pressing and holding the \* button.

When the phone reboot is complete, the **Language Menu** will display. Press the **Yes** soft button to advance to the **Configuration Menu**.

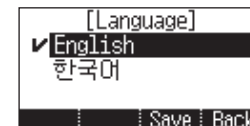

Once the **Configuration Menu** is displayed, you can move to each menu in the Setup by using the navigation button and [1]-[8] dial buttons of the SMT-i5220 IP phone. [To learn how to navigate the menus refer to the previous section.](#)

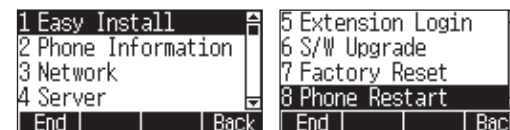

## EASY INSTALL WIZARD

By selecting this option, the System Easy Wizard can guide you through setting up your network parameters. If you want to set up these parameters individually, follow the instructions below.

- From the idle phone press **Menu**, scroll to **Phone**, and press **OK** button. Scroll to **Phone Information** and press **OK** button. From the keypad, enter the administrator's password (please contact your phone system administrator). Scroll to **Easy Install** and press **OK** button.

## SELECTING THE STATIC IP OPTION

- When the Static IP option is selected, enter the System Type OSSP (KP), and press **OK**.
- Enter the **Static IP Address** for the phone (eg. 192.168.9.193) then press the **OK** button.
- Enter the **Subnet Mask** (eg. 255.255.255.0); press **OK** button.
- Enter **Gateway Address** (eg. 192.168.9.1), press **OK** button.  
**NOTE:** Press the \* key on the dial pad to enter the "." in the IP address.
- Skip [VLAN-PHONE], [VLAN-PC], [802.1x Setting] by pressing the **OK** button three times.
- Enter the **System IP address** (eg. 192.168.9.200), press **OK** button.
- Enter **System ID** XXXX (eg. 3201), then press **OK** button.
- Enter **Password** XXXX (eg. 1234) then press **OK** button.

Wait a second for the phone to reboot. The phone should register and authenticate itself to the phone system. Test SMT-i5220 for proper operation.

## SETTING UP HOT DESKING [IDLE LOGIN]

Hot Desking allows you to log in and out of your SMT-i5220 IP keyset without rebooting.

- Press the **Menu** soft button, scroll to **Phone** then press **OK** button.
- Scroll to **Phone Information** and press **OK** button.
- Enter the administrator's password (please contact your phone system administrator).
- Scroll to **Extension Login** then press **OK** button.
- Choose the **ON** option and press **OK** button. (Note: **ON** to allow, **OFF** to deny hot desking).
- Press the **Save** soft button to complete the setup.
- When the phone restarts, enter the **ID** (eg; extension 2809) and **password**.
- Press the **Save** soft button to complete the login.

## CONFIGURATION MENU STRUCTURE

This menu is for administrator use and a password is required. The **Configuration Menu** options are as follows:

### 1. EASY INSTALL

This option will guide you through setting up all required parameters for connecting the SMT keyset to your system.

### 2. PHONE INFORMATION

1. Version Info: Provides boot rom, software, DSP, and hardware version information.
2. Network Info: Displays network mode, IP address of phone, network, and gateway information.
3. MAC Address

### 3. NETWORK

Displays Static IP, Dynamic IP, PPPoE, NAT, 802.1x, VLAN (LAN), and VLAN (PC).

### 4. SERVER

1. Primary System: The main processor's IP address.
2. System 1~3: Up to 4 server IPs can be set.

### 5. EXT. LOGIN

Allows the user to choose the option of permitting the phone either login/logout from idle mode or only register to the server on power up. Once the phone is placed into Extension Login mode, a display will show up to allow you to enter any valid User ID and password. This function is also referred to as hot desking (idle login).

### 6. S/W UPGRADE

1. TFTP Server: The IP address of the TFTP server containing the IP software.
2. Upgrade: Starts the IP software upgrade process.

### 7. FACTORY RESET

This option resets the SMT-i5220 to factory default settings.

### 8. PHONE RESTART

This option reboots the SMT-i5220 phone.



## SECTION 3. FREQUENTLY USED FEATURE OPERATION

This section provides the basic operation of your Samsung Multimedia Telephone **SMT-i5220**.

### EXTENSION LOG IN & OUT [HOT DESKING]

If enabled, your SMT-i5220 telephone may require you to log in before making or receiving calls. In these cases your telephone system administrator will provide you with an extension number, password, and the feature code used to log out.

#### TO LOG IN

- Dial your extension number in the ID field (example 3201).
- Press the **OK** button.
- Dial your password in the password field (example 1234).
- Press **Save** soft button.



The screenshot shows a screen titled "[Extension Login]". It has two input fields: "ID" and "Password:". The "ID" field contains the number "3201" and the "Password:" field contains "1234". At the bottom of the screen, there are three soft buttons: a "+" button, a "1" button, and a "Save Del." button.

#### TO LOG OUT

- Dial the feature code provided by your administrator (for example 77).

### PLACING CALLS

**IMPORTANT:** Put your phone in **Overlap Mode** by pressing the **Menu** button, select **Settings** and then select **Application Set.**, press **OK**, select **Call**, press **OK**, scroll to **Dial Mode**, change it to **Overlap** by using the Navigation Button. If your phone is not in Overlap mode you must always press the **Call** soft button after dialing the digits to send the call.

**NOTE:** All examples of making phone calls are based on the phone being set for overlap dialing mode.

**OUTSIDE CALLS -** To place a call to an outside party:

- Lift the handset.
- Press an idle outside line button, line group button, or dial a line access code to receive dial tone.
- Dial the telephone number.
- Hang up the handset when the call is completed.

**NOTE:** Frequently called telephone numbers can be added to the PhoneBook.

When making internal and external calls from AOM (programmable) list, press the **AOM** soft button to access the programmable button screens. Then use the **Navigation** button to scroll to and highlight the desired programmable button. Press **OK** to complete the call.

**INTERNAL CALLS** - To place a call to another extension at your location:

- Lift the handset.
- Dial the extension number or group number.
- Wait for the party to answer. If you hear a brief tone burst instead of ringback tone, the station called is set for Voice Announce or Auto Answer. Begin speaking after the tone.
- Hang up the handset when the call is completed.

**NOTES:**

1. If you have a **DSS** button assigned to an extension or station group, you may press this button instead of dialing the number.
2. If the Hot Keypad feature has been turned off, you must first lift the handset or press the **Speaker** button before you begin dialing.

**SPEAKERPHONE CALLS** - Your Samsung SMT-i5220 has speakerphone capability. This feature is used for both internal or external calls. To activate this feature:

- Press the **Speaker** button.
- Place an internal or external call.
- Press **Speaker** button to disconnect the call.

**NOTE:** The handset can be used at any time during the conversation. To resume handsfree operation, press the **SPEAKER** button, and hang up the handset.

**HEADSET CALLS** - If a headset is connected to the phone, you need to press the headset key to direct the call to the headset. The headset key will be lit. To use the headset:

- Press the **Speaker** button.
- Place an internal or external call.
- Press **Speaker** button to disconnect the call.

**NOTES:**

1. If you need to switch between the headset and the handset during the call, you need to place the call on hold first.
2. Headset key can be enabled or disabled in the Menu, Settings, Application Setting, Headset.

## ANSWERING CALLS

**OUTSIDE/INTERNAL/VOICE ANNOUNCE CALLS** - To answer these three types of calls:

- Lift the handset or press the **Speaker** button to answer on **Speakerphone**.
- Hang up the handset when the call is completed.

**NOTE:** The volume can be adjusted at any time by pressing the up and down buttons on your navigation button.

## PLACING A CALL ON HOLD

Calls can be placed on **System Hold** or **Exclusive Hold**. A call placed on System Hold can be picked up from any extension. Calls placed on Exclusive Hold can only be picked up from the extension that placed them on hold.

**SYSTEM HOLD** - To place a call on hold:

- Press the **Hold** button. The **Call** button will flash green at your telephone.
- To take the caller off hold, press that button and the red flashing light will go steady red again.
- Resume conversation.

**EXCLUSIVE HOLD** - To place a call on hold at your telephone so that other users cannot answer it:

- Press the **Hold** button twice. The call button will flash green at your telephone.
- To retrieve the call, press the flashing red line button or press the line button a third time.

**NOTE:** Internal calls are always placed on exclusive hold.

## TRANSFERRING CALLS

You can transfer a call by notifying the party to which the call is being transferred or without notification.

- While on a call, press the **Transfer** button then dial an extension number.
- Confirm you hear a ringback tone.
- Wait for the called party to answer and announce the call (optional).
- Replace the handset.

## TRANSFERRING WITH CAMP-ON

When you transfer a call to another station and receive a busy signal, you can camp the call on to this station. Hang up when you hear the busy signal. The called party is alerted that a call is waiting.

- Call another internal station.
- When receiving a busy tone, press the **Func.** soft button.
- Scroll to **Camp On** and press **OK** button (here ringback tone). Wait for party to answer the call.

**NOTE:** If you receive No More Calls tone, that station has no button available to receive another call. Press **Transfer** to return to the caller.

## CALL WAITING

If an outside call is camped-on to your phone or another station is camped-on to you:

- Your keyset rings and the call that is waiting (camped-on) flashes red.
- Press the flashing button to answer; the other call is put on hold automatically if your station has the Automatic Hold feature set. If not, you must press **Hold** and then the flashing button or finish the first call and hang up; the waiting call will ring.
- Lift the handset or press the **Speaker** button to answer.

**NOTE:** Intercom calls will not go on Automatic Hold.

## CONFERENCE CALLS

To make a conference call while engaged in a conversation:

- Press the **Conference** button and receive conference tone.
- Make another call, either intercom or outside, press the **Conference** button and receive conference tone.
- Make another call or press the **Conference** button to join all parties. You can conference up to five parties (you and four others).
- Repeat the last step until all parties are added.
- Hang up to leave the conference call.

**NOTE:** When attempting to add another party to the conference and you are not able to reach the desired person, hang up. Simply press the **Conference** button again to return to the previous conversation.

### To drop a party from your conference call:

- ▶ Press the **Conference** button and dial the extension or line number that is to be dropped.
- ▶ Press the **Conference** button again to reestablish the conference.

## FORWARDING CALLS Icon

You can forward your calls to another station, group of stations, or an external telephone number. Program a destination for the type of forwarding you want by moving the **Selector Switch** to the **left** and set the **forwarding number for All, Busy, No Answer, and Busy/No Answer**.

## OTHER FEATURES AND FUNCTIONS

**VOLUME CONTROL - Vol** button is used to adjust the volume of a handset, speaker and ringing sound.

### Volume Control of a Handset

- Adjusts the handset volume while busy (handset offhook).
- To increase the volume of a handset, press the top side [+] of the **Vol** button.
- To decrease the volume of a handset, press the bottom side [-] of the **Vol** button.

### Volume Control of a Speaker

- Adjusts the speaker volume while busy (handsfree).
- To increase the volume of a speaker, press the top side [+] of the **Vol** button.
- To decrease the volume of a handset, press the bottom side [-] of the **Vol** button.

### Volume Control of a Ringing Tone

- To increase the volume of a speaker, press the top side [+] of the **Vol** button while ringing.
- To decrease the volume of a handset, press the bottom side [-] of the **Vol** button while ringing.

### Volume Control of Key Tone

- To increase the volume of the key tones, press the top side [+] of the **Vol** button.
- To decrease the volume of the key tones, press the bottom side [-] of the **Vol** button.

**NOTE:** By pressing the **Vol** button in idle mode, the user can also adjust the key tone volume

**LAST NUMBER REDIAL** - To redial the last dialed telephone number, press the **Func.** soft key scroll to **Last Redial** and press **OK**.

**PHONE BOOK BUTTON** - Provides direct access to Personal Phonebook (local to the phone) or Company phonebook (requires set-up by administrator).

**MESSAGE BUTTON** - This function allows users to select which desired type of messages is viewed. Users can select and view the following options: **Voicemail Messages, Station Messages, E-Mail** (optional with IP-UMS only), and **Short Message Service** (SMS). Short Message Service is similar to sending text messaging [Function only supported on Samsung IP phones].

**SERVICE BUTTON** - Used to allow station users access to setting and editing the scheduler (alarm clock) feature. Also used to connect the OfficeServ Communicator when application is available (UC is optional).

**MENU SOFT BUTTON** - This menu displays the following options:

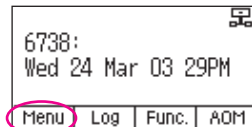

**NOTE:** The **Navigation** button can be used to scroll through these options.

1. **PHONEBOOK:** Maintains frequently dialed names and numbers in a PhoneBook. Search and initiate calls by: Speed Dial, Associated Names, Telephone Numbers, Assigned Groups, or Previous Calls registered to your phone.
2. **CALL LOG:** Provides direct access to a list of most recent calls, outgoing calls, incoming calls, missed calls, and an option to delete/delete all (or clear) all calls from the **Call Log**.
3. **MESSAGES:** This function allows users to select which desired type of messages is viewed. Users can select and view the following options: **Voicemail Messages, Station Messages, E-Mail** (optional with IP-UMS only), and **Short Message Service** (SMS). Short Message Service is similar to sending text messaging [Function only supported on Samsung IP phones].
4. **CONFERENCE:** Allows a user to setup a **conference group** to call multiple parties simultaneously to join the conference call.
5. **SERVICE:** Allows a user to set the scheduler (reminder) function.
6. **PHONE:** Allows the user to set many phone options for the phone such as ring tones, background screens, languages, forward, DND, etc.
7. **SETTINGS:** This function allows the user to set the following option: **Application Set., Call Forward, Absent Message, AOM Setting, Network Info.,** and **Clear User Set.**

**CALL LOG BUTTON** - Provides direct access to a list of most recent calls, outgoing calls, incoming calls, missed calls, and an option to delete all (or clear) all calls from the **Call Log**.

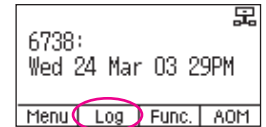

**FUNC. SOFT BUTTON** - This function allows a user one touch easy access to many of the system features. When pressed, the following options are displayed: Last number redial, Save/Repeat, Speed Dial, Directory, VM Message, Station Message, Page Pickup, Direct Pickup, DND, In/Out Group, Status Message, Hold pickup, Page, Meet me Page, OHVA Block, Group Pickup, and My Group Pickup. The **Navigation** button can be used to scroll up and down the list of features under the **Func.** button.

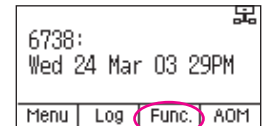

**NOTE:** **EXE/SECR MSG** is displayed only when the phone is programmed for Boss/Secretary feature.

**Example of using the Last Number Redial feature:**

- ▶ Press the **Func.** Soft button, scroll to **Last Redial**, then press **OK** button. The last number called from the phone is called.

**NOTE:** For detail operation of the list of features under the Func. soft button, please refer to the System Features section of the user guide.

**AOM SOFT BUTTON** - This function is used to display all 99 programmable feature buttons of the phone. The **Navigation** button can be used to scroll up and down the list of 99 programmable feature buttons under the soft AOM. The feature buttons can be programmed by a technician.

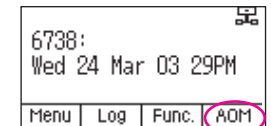

**Example of dialing a Speed Dial Number using the AOM function:**

- ▶ Press the **AOM** soft button, scroll to **Speed Dial**, then press **OK** button. The number is called from the phone.

**NOTE:** Some programmed features such as speed dialing and DSS buttons can be used to process calls; other programmed buttons such as Call buttons can only be viewed.

The soft AOM button can also display status indications for station keys, trunks, voice mail messages, etc.

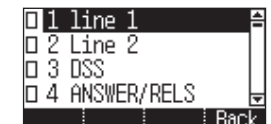

**Example of programming a DSS button on the soft AOM:**

- ▶ Press the **Menu** soft button.
- ▶ Using the **Navigation** button, scroll to **Settings** and press **OK**, then scroll to and select **AOM Setting**.
- ▶ Scroll to the soft **AOM** button to program (for example: 4).
- ▶ Press the **Edit** soft button (the display will show AOM index 4).
- ▶ Press **Edit** soft button again, scroll to the feature option (for example: DSS).
- ▶ Move down and enter the extension number (for example: 2003).
- ▶ Move down, use the dial pad to enter name (for example: John Dow). [Refer to Text Input Method.](#)
- ▶ Press the **Save** soft button to exit and save the setting.

**OK/ENTER BUTTON** - This function is used to enter, save or complete the selected option in the display.

**SPEAKER BUTTON** - This function is used to go on and off hook in the hands-free speakerphone mode.

## SECTION 4. PHONE FEATURES

# BASIC MENUS

The basic menus screen is displayed if you select the **Menu** from the soft menu at the left bottom of a idle screen. Using the **Up/Down** button, move to a desired function, and press the **OK** button to execute the function.

## SOFT BUTTON STRUCTURE

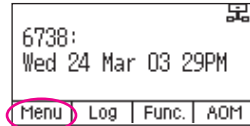

## MENU SOFT BUTTON

Item	Sub-Item	Description	
<b>1. Phonebook</b>	All	Shows the entire list of phone numbers stored in the phone.	
	<b>Personal Phonebook</b>	Unassigned	This is a list of number that are not assigned any group.
		Search	Allows a user to search for a registered phone number by name/number.
		New	Saves a phone number or group name; and allows a user to specify a speed dialing number and ringtone.
		Edit [+]	Allows a user to delete all the phone numbers saved in the phone.
<b>2. Call Log</b>	Call	Used to make a callback from the call log.	
	Save	This is used to save entries from call log to phonebook.	
	[+] Delete	This is used to delete entries from the call log.	
	Back	This is used to to move back one menu screen.	
	Delete All	Allows a user to delete all the call history saved in the phone.	
<b>3. Messages</b>	1. Voice Mail [0]	Allows a user to retrieve voice mail messages from the mailbox.	
	2. Station Message [0]	Allows a user to retrieve station messages (internal) from another user.	
	3. Email [0]	Allows a user to to view how many e-mail messages have been received via IP-UMS (optional).	
	4. Short Message	Allows a user to retrieve and send internal short messages (SMS) like text message to other internal phones. <i>[Not Supported Over Networking]</i>	

Item	Sub-Item	Description	
<b>4. Conference</b>		Allows a user to setup (show, add and edit) a <b>conference group</b> to call multiple parties simultaneously to join the conference call.	
<b>5. Service</b>		Allows a user to set the alarm clock function.	
	1. Scheduler	Allows the user to set a timed reminder alarm to give an audible indication or alarm clock function.	
<b>6. Phone</b>		Allows the user to set many phone options for the phone such as ring tones, background screens, languages, etc.	
	1. UC Dial: Right	Options are <b>DND</b> and <b>Absent Message</b> .	
	2. Screen	Options are <b>Display Time, Font,</b> and <b>LCD Power</b> .	
	3. Sound	Options are <b>Volumes, Ring Tone,</b> and <b>Key Tone</b> .	
	4. Language	Multiple languages are available.	
	5. Security	Change <b>Password, Dial</b> and <b>Phone Lock</b> .	
	6. Phone Information		<b>Easy Install:</b> Used to register and authenticate the phone to the server.
			<b>Phone Information:</b> Includes Version Info, Network Info, and MAC Address.
			<b>Network:</b> Options are Static IP, Dynamic IP, PPPoE, VLAN (LAN Port), VLAN (PC Port), 802.1x.
			<b>Server:</b> Used to register the phone to one or more Servers. Options are Primary, System 1, System 2, and System 3.
		<b>Extension Login:</b> Used to log phone on and off (Hot Desking).	
	<b>S/W Upgrade:</b> Upgrade Server, Upgrade: used to upgrade software on phones.		
	<b>Factory Reset:</b> Used to default the phone settings.		
	<b>Phone Restart:</b> Used to reboot the phones.		
	<b>License:</b> Display the licensing policy.		

Item	Sub-Item	Description
<b>7. Settings</b>  <i>Note: All options are not explained in this manual. The options are initiative and menu driven for an easy, user friendly menus to guide you through navigating the Setting Menu Options.</i>		This function is used to allow station users to set <b>application settings</b> , call forwarding, absent messaging, AOM setting, view station network information, view phone firmware or initialize the phone. Other settings include the following:
	1. Application Set.	Options are <b>Call</b> (CID 1, CID 2, Dial Mode), <b>Phone Number, Boss Answer, Short Message, Station On/Off</b> , and <b>Extension Login</b> .
	2. Call Forward	Options are <b>Not Use, All, Busy, No Answer, Busy/No Answer, DND</b> , and <b>Follow Me Status</b> .
	3. Absent Message	Used to leave <b>station messages</b> in display informing other internal parties of your status when your station is called.
	4. AOM Setting	Used to set the name, number, and function to the <b>99 AOM buttons</b> .
	5. Network Info.	Used to view the current <b>network settings</b> .
	6. Clear User Set.	<b>Clear</b> your local setting such as <b>phone book, call log</b> , etc.

## 1. PHONEBOOK

Company phonebook requires setup by the System Administrator.



### PERSONAL PHONEBOOK

**NOTE:** Personal phonebook is stored locally in phone memory.

#### All

Shows the entire list of phone numbers saved in the phone book.

- Press the **Phone Book** button—**OR**—press the **Menu** soft button, scroll to **Phonebook**, press **OK**, scroll to **All**, and then press **OK**.
- The entire list of phone numbers saved in the phone book is shown on the screen. Using the **Navigation** button, move to a desired entry, and select the **Call** soft button to place a call.

#### Unassigned Group

The Unassigned option is a list of all the phonebook entries that have not been assigned to a group. Once an entry is assigned to a group, the entry is removed from the unassigned list.

#### TO CREATE A PHONEBOOK GROUP

To create a group in the phonebook:

- Press the **Phonebook** button, then press the [+]**]** soft button, then press the **New** soft button.
- Using the key pad, input the name of the group, then press the **Save** soft button. [See Text Input Method.](#)
- Press **Edit** soft button or press **Back** soft button to exit.

#### TO MOVE UNASSIGNED ENTRY TO PHONEBOOK GROUP

- Press the **Phonebook** button, scroll to **Unassigned** option then press **OK** button.
- Scroll to the entry that is to be moved to an assigned group and press **OK** button.
- Press **Edit** soft button, scroll to and highlight the **Group** option.
- Using the **Navigation** button, move **Left** or **Right** to the group name (eg; Personal) which you want to move the entry into.
- Once the correct entry is displayed, press the **Save** button. The entry is now assigned to the group.

## Search

Allows a user to search by name/number for a phone saved in the phone book.

- Press the **Phonebook** button—OR—press the **Menu** soft button, scroll to **Phonebook**, press **OK**.
- Press the **Search** soft button from the dial pad enter the characters of the name (case sensitive) or number to search and press the **OK** button, the matching phone number is displayed. Move to a desired name/number using the **Navigation** button, and select the **Call** soft button to place a call.

## Add New Entry to Phonebook [+]

This is the function used to register a phone number.

- Press the **Phonebook** button—OR—press the **Menu** soft button, scroll to **Phonebook**, press **OK**.
- Press the **[+]** soft button, and then **New**.
- Enter a **name** by using the dial pad, scroll down and enter a **mobile number, home number, office number, internal extension number, fax number, and e-mail address**.
- Assign a **Group** (if needed).
- Select a **Ring Tone**.
- Add **Memo** information (up to 50 characters).
- Press the **Save** soft button to save the new entry to the Phonebook.

## DELETE / DELETE ALL

This is the function used to delete all the phone numbers saved in the phone book.

- Press the **Phonebook** button—OR—press the **Menu** soft button, scroll to **Phonebook**, press **OK**.
- Scroll to **All** and press **OK** button. Scroll to entry to delete.
- Press **[+]** soft button. Press **Del.** to delete the selected entry or **Del All**.
- Press the **Yes** to **Delete** entry.

## 2. CALL LOG

 **Outgoing**

 **Incoming**

 **Missed Icons**

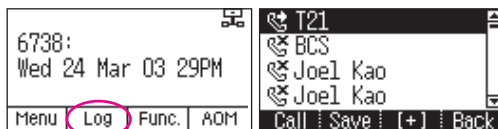

This function lists all the recent numbers for outgoing, incoming and missed calls.

- Press the **Log** soft button—OR—press the **Menu** soft button, scroll to **Call Log**, press **OK**. A phone number list of recent outgoing, incoming and missed calls is displayed.
- Scroll to an entry and press the **Call** soft button to dial the number.

## VIEWING DETAIL CALL LOG RECORD

To view the details of each of the call log entry, highlight the entry and press the **OK** button to display the full Caller ID record which includes the name, date and time.



## DELETE / DELETE ALL

This is the function used to delete an entry or all entries in the Call Log.

- Press the **Menu** soft button, scroll to **Call Log**, press **OK**.
- Scroll to entry to delete.
- Press **[+]** soft button. Press **Del.** to delete the selected entry or **Del All**.
- Press the **Yes** to **Delete** entry.

## TO ADD A CALL LOG ENTRY TO PHONE BOOK

- Press the **Menu** soft button, scroll to **Call Log**, press **OK**. Scroll to desired **Call Log entry** and press the **Edit** soft button. Make changes to the name and number if necessary. When finished, press the **Save** soft button. The Call Log number is added as a new entry to the phonebook list.

## 3. MESSAGES

### 1. Voice Mail



This function allows users to retrieve voice mail message from the mailbox.

- Press the **Message** button—OR—press **Menu** soft button, scroll to **Messages**, press **OK**, scroll to **Voice Mail [ ]**, and then press **OK** to access the voicemail box and retrieve messages.

### 2. Station Message

This function allows users to retrieve station messages (internal) from another user.

- Press the **Message** button—OR—press the **Menu** soft button, scroll to **Messages**, press **OK**, scroll to **Station MSG [ ]**, and then press **OK**.
- To return a call to the station that left the message: press the **Func.** soft button, scroll to **Reply**, then press **OK**.
- To delete the station message: press the **Func.** soft button, scroll to **Clear**, then press **OK**.
- To view the next station message: press the **Func.** soft button, scroll to **Next**, then press **OK**.



### 3. E-Mail

This function allows users to view the amount of e-mails for a station user's account. This function is only available when the IP-UMS application is enabled. Please refer to the IP-UMS manuals for detailed operation.

### 4. Short Message (SMS)

This function is used to send and create internal short messages or text messaging.

#### INBOX

- Press the **Message** button—**OR**—press the **Menu** soft button.
- Scroll to **Short Message**, press **OK**.
- Scroll to **Inbox**, then press **OK** to view a short text message(s) in your Inbox.
- Press the **[+]** soft button, press **Del.** soft button, and the **Yes** soft button to delete the selected short text message or press the **Back** soft button to exit Short Message.

#### NEW MESSAGE (SEND)

This function is used to create and send a new short text message.

- Press the **Message** button—**OR**—press the **Menu** soft button.
- Scroll to **Short Message**, press **OK**.
- Press **New Msg** soft button. Write or create a new short message and press the **Next** soft button. [See Text Input Method on how to enter characters in text messages.](#)
- Enter the internal extension(s) to send the short message. Scroll to other entries and enter the station number to send to more users. (Each short message can be sent to 1 through 10 users).
- Press the **Send** soft button to deliver the short message to other user's inbox.

#### NOTES:

1. When the message is sent successfully, the message "Sent" is displayed. When the message fails to send the "Failed to send" is displayed.
2. SMS messages can only be sent to internally ITP, SMT-W, or SMT-i phones. TDM and single line phones cannot send or receive SMS messages. SMS messaging is not supported over networking.

#### OUTBOX

This function is used to create and send a new short text message.

- Press the **Message** button—**OR**—press the **Menu** soft button.
- Scroll to **Short Message**, press **OK**.

- Scroll to **Outbox**, then press **OK** to view short text message sent from your phone.
- Press the **[+]** soft button, then **Del/Del All** soft button to delete the short text message(s) or press the **Back** soft button to exit SMS.

### 4. CONFERENCE [Group]

This function allows a user to setup a conference group to call multiple parties simultaneously to join the conference call.



#### CREATING CONFERENCE GROUP

- Press the **Menu** soft button, scroll to **Conference**, and press **OK**.
- Press **New** soft button, enter phone number (up to 4 numbers) of the parties included in the Conference Group.
- Press the **Call** soft button to initiate the Conference Group.

#### TO CREATE AN UNSUPERVISED CONFERENCE

- During the conference, the host can press the **Host** soft button.
- The host is dropped and the other parties remain in conference.

#### TO DISCONNECT A PARTY FROM CONFERENCE GROUP

- Highlight the party to be disconnected from the conference group.
- Press the **Disc.** soft button. The party is disconnected.
- Press the **Call** soft button to call back and add the party back to the conference group.

#### SAVING A CONFERENCE GROUP

- After completing the group conference, press the **Save** soft button.
- Enter the **Name of the Group**, and press **Save** soft button.

#### TO EDIT A CONFERENCE GROUP

- Press the **Menu** soft button, scroll to **Conference** button, and press **OK**.
- Scroll to the **Name of the Group** to be edited and press **Edit** soft button.
- Edit the group name. When complete, press the **Save** soft button to save changes.

#### TO EDIT CONFERENCE GROUP PHONE NUMBER LIST

- Press the **Menu** soft button, scroll to **Conference** button, and press **OK**.
- Scroll to the **Name of the Group** to be edited and press **Edit** soft button.
- Press the **Edit** soft button. Edit the phone number list—**OR**— Press **Search** soft button to search for phone number to add to group from

the phonebook. Highlight the entry and press the **OK** button to add the number to the Conference Group list.

- When complete with the editing, press the **Save** soft button to save changes.

## 5. SERVICE

Allows a user to set the alarm clock function.



- Press the **Service** button—**OR**—press the **Menu** soft button, scroll to **Scheduler**, then press **OK**.
- Press the **New** soft button.
- Enter the name of the scheduler using the dial pad and navigation buttons.
- Press the **Next** soft button. Enter the Date, Time, Alarm Type, and Ring Tone. Press **Save** soft button when finished.

### TO DELETE A SCHEDULE

- Press **Menu** soft button. Scroll to **Service** button, and press the **OK** button.
- Select **Scheduler** and press the **OK** button.
- To delete a current schedule, press the **[+]** soft button.
- Select and highlight the entry to be deleted and press **Delete** soft button—**OR**—press the **Delete All** soft button to clear all schedules.
- Select **Yes** to confirm or **No** to deny the deletion of a schedule(s).
- Press **Back** and **End** soft buttons to exit the scheduler.

## 6. PHONE

Allows the user to set many phone options for phone such as ring tones, background screens, languages, etc.



### 1. UC Dial: Right

This option is used to select which function will be enabled when the selector switch is moved to the right position.

- Press the **Menu** soft button. Scroll to **Phone** and press **OK**.
- Scroll to **UC Dial: Right** and press **OK**.
- Select **DND** or **Absent Message** and press **Save** soft button.

### 2. Screen

- Press the **Menu** soft button. Scroll to **Phone** and press **OK**. Select **Screen** and press **OK**. Set the following **Time Format**, **Font**, and **LCD Power Saving** of the SMT-i5220 phone, select the option and adjust the screen settings.
- Press the **Save** soft button to store the screen settings.

### 3. Sound

- Press the **Menu** soft button. Scroll to **Phone** and press **OK**. Select **Sound** and press **OK**. Set the following **Volumes**, **Ring Tone**, and **Key Tone** of the SMT-i5220 phone, select the option and adjust the sound settings.
- Press the **Save** soft button to save the sound settings.

### 4. Language

- Press the **Menu** soft button. Scroll to **Phone** and press **OK**. Select **Language** and press **OK**. Select English (Default English).
- Press the **Save** soft button.

### 5. Security

- Press the **Menu** soft button. Scroll to **Phone** and press **OK**. Scroll to **Security** and press **OK**.
- Enter the station password [default 1234].
- Press **OK** to Change Password and press **Back** soft button.
- Scroll to **Dial** to **Unlock**, **Lock Out** (Outgoing), or **Lock All**.
- Scroll to **Phone** to **Unlock** or **Lock** the Menu.
- Press the **Save** soft button.

### 6. Phone Information

Allows a user to set up the following options: **Easy Install Wizard** (registering the phone), **Phone Information** (Version, Network, MAC Address), **Network** (Static, Dynamic, etc.), **Server** (Phone can register to 1 to 4 servers), **Extension Login** (logging in and out IP phones), **Software Upgrade** (Upgrading the phone or server software), **Factory Reset** (defaulting the phone), and **Phone Restart** (rebooting the phone).

## 7. SETTINGS

This function is used to allow station users to set **Application Settings**, **Call Forward**, **Absent Message**, **AOM Setting**, **Network Information**, and to **Clear User Settings** such as Call Log and Phonebook.



## FUNC. SOFT BUTTON

This function allows a user one touch easy access to many of the system features. When pressed, the following options are displayed: **Last Number Redial, Save/Repeat, Speed Dial, Directory, VM Message, Station Message, Page Pickup, Directory Pickup, DND, In/Out Group, Status Message, Hold Pickup, Page, Meet Me Page, OHVA Block, Group Pickup, and My Group Pickup.** The Navigation button can be used to scroll up and down the list of features under the **Func.** button.

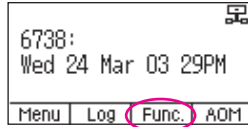

**NOTE:** [For detailed operation of the list of features under the Func. soft button, please refer to the System Features section of this user guide.](#)

## AOM SOFT BUTTON

This function is used to display all 99 programmable feature buttons of the phone. The **Navigation** buttons can be used to scroll up and down the list of 99 programmable feature buttons under the AOM module. The feature buttons can be programmed by a technician.

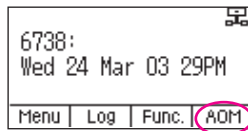

# SECTION 5. OFFICESERV™ 7000 SYSTEM FEATURES

# OUTSIDE CALLS

## MAKING CALLS FROM AOM

**Note:** When making calls, internal or outside calls, in order to access the programmable button screens, press the **AOM** soft button. Then you can utilize the **Navigation** button to scroll the list.

- When the desired number is highlighted, press the **OK** button.
- The number will be automatically dialed.

## UNIVERSAL ANSWER

Outside lines may be programmed to ring a general alerting device. To answer calls ringing this device, dial **67—OR—**press the **UA** button. This device can operate in any one of the six different ring plans.

**NOTE:** If the Hot Keypad feature has been turned off, you must first lift the handset or press the **Speaker** button before dialing.

## RECALL DIAL TONE

- Press the **New** button to disconnect your existing call, wait for dial tone and then make a new call on the same line.

**NOTE:** If this button does not appear on your keyset, the **Flash** button may be programmed to recall dial tone.

## SENDING A FLASH

While on an outside call, press the **Flash** button to send a flash to the telephone company. This is required for some custom calling features or CENTREX use.

**NOTE:** Flash is not available on an ISDN circuit.

## BUSY LINE QUEUING WITH CALLBACK

If you receive a busy signal when you are selecting an outside line, this means that the line or group of lines is busy.

- Press the **Callback** button, if programmed, or dial **44**, you will hear confirmation tone.
- Hang up or press **Speaker** button.
- When the line becomes free, the system will call you back.
- Lift the handset or press the **Speaker** button to answer, wait for dial tone and dial the telephone number or speed dial number again.

NOTES:

1. A callback will be canceled if not answered within 30 seconds. If you have set a callback, the cursor associated with the **Callback** button will be solid black.
2. If the Hot Keypad feature has been turned off, you must first lift the handset or press the **Speaker** button before dialing.

## BUSY STATION CALLBACK

When you call another station and receive a busy signal:

- Press the **Callback** button, if programmed, or dial **44**.
- When the busy station becomes free, your keyset will ring.
- Lift the handset or press the **Speaker** button to call the now idle station.

NOTES:

1. A callback will be canceled if not answered within 30 seconds. If you have set a callback, the cursor associated with the **Callback** button, will be solid black.
2. If the Hot Keypad feature has been turned off, you must first lift the handset or press the **Speaker** button before dialing.

## CANCELING CALLBACK

A callback will be canceled if not answered within 30 seconds. If you have set a callback, the cursor associated with the **Callback** button, will be solid black.

To cancel a callback:

- Press the **Callback** button, if programmed, or dial **44**. The display will show the callback details, press the **Func.** soft button and then **Clear**.
- This will cancel the last set callback and display the next set callback, also with the option to **Clear**. This process is repeated until all callbacks are cleared from memory.

**NOTE:** If the Hot Keypad feature is turned off, you must first lift the handset or press the **Speaker** button before dialing.

## BUSY STATION CAMP-ON

When you call another station and receive a busy signal but you do not want to wait for a callback:

### MANUAL CAMP-ON

- Press the **Camp** button or dial **45**.
- The called station will receive off-hook ring tone repeated every few seconds and the cursor associated with the first available **Call** button will flash black to indicate your call is waiting.
- Wait for the called party to answer.

- The called station must release its first call or place it on hold before answering your camp-on.

#### NOTES:

1. If you receive No More Calls tone, that station has no available button to accept your call. Hang up or leave a message.
2. If the Hot Keypad feature has been turned off, you must first lift the handset or press the **Speaker** button before dialing.

#### AUTO CAMP-ON

When you want to automatically camp on to a busy station without pressing the camp on button every time you call a busy station, you can set your phone for auto camp-on.

- With the handset on-hook, press **Transfer** and then dial **110**.
- Dial **081** to turn **On** auto camp-on or dial **080** to turn it **Off**.
- Press **Transfer** to store your selection.

## INTERCOM CALLS

### VOICE ANNOUNCE MODE

When another station calls you, your keyset will sound a brief attention tone and you will hear the caller's announcement.

- Press the **Speaker** button to turn on the microphone and speak handsfree—**OR**—lift the handset to reply.
- To finish the call, replace the handset or press the **Speaker** button.

NOTE: In order for C.O. calls to be answered handsfree, AUTO ANS CO must be set to ON.

### AUTO ANSWER MODE

When another station calls you, your keyset will sound a brief attention tone and then automatically answer the call.

- Your microphone and speaker are turned on and you can speak handsfree. For privacy, use the handset.
- To finish the call, replace the handset.

NOTE: In order for C.O. calls to be answered handsfree, AUTO ANS CO must be set to ON.

### CALLING YOUR SYSTEM OPERATOR

- Dial **0** to call your system operator or group of operators.
- If you want to call a specific operator, dial that person's extension number.

NOTE: If the Hot keypad feature has been turned off, you must first lift the handset or press the **Speaker** button or dial **0** before you begin dialing.

# CALL PROCESSING

## SYSTEM HOLD

When you are connected to any call, press **Hold**. The call will flash at the keyset. If this call appears on a line button at other keysets, it will flash at those keysets also.

- To take the caller off hold, press that button and the flashing LED will go steady again. Resume the conversation—**OR**—press the **Hold** button. The flashing LED will go steady again and you will be connected to the call again. Resume the conversation.

NOTE: While on a call, pressing a line button, route button or flashing **Call** button will automatically put your first call on hold and connect you to the new call. [See Automatic Hold under Customizing Your Keypad.](#)

## EXCLUSIVE HOLD

To place an outside call on hold at your phone so that other users cannot get it:

- Press the **Hold** button twice. The call will flash on your keyset and this line will show a steady indication on other keysets.
- To retrieve the call, press the flashing line button or press the **Hold** button a third time.

NOTE: Intercom calls will always be placed on exclusive hold.

## REMOTE HOLD

When you wish to place a call on hold at another station.

- Press **Transfer** and dial the station number (or press the appropriate **DSS** button)
- Press the **Hold** button. This will place the call on system hold on an available **Call** button or Line button at the remote station and return you to dial tone.

NOTES:

1. If the destination station does not have any free **Call** buttons or line buttons you will hear No More Calls tone and must return to the other party by pressing the **Transfer** button.
2. Intercom calls cannot be put on remote hold.

## HOLD RECALL

If you leave a call on hold longer than the hold timer, it will recall your station. The button that the call appears on will have a slow flashing indicator.

- When your phone rings, lift the handset or press the **Speaker** button to answer the recall.
- If you do not answer this recall within a pre-programmed period of time, it will go to the system operator.

NOTE: The Led will flash amber during hold recall.

## CONSULTATION HOLD

When you are talking on an outside line and it is necessary to consult with another extension:

- Press the **Transfer** button; you will receive transfer dial tone. Your call is placed on transfer hold.
- Dial the extension number.
- Consult with the internal party.
- Press **Transfer** to return to the outside party or hang up to transfer the call.

NOTE: Repeatedly pressing the **Transfer** button will toggle between the outside party and internal extension. If necessary you may disconnect either one of the parties by pressing the **Func.** soft button, then press the **Cancel** soft button.

## RETRIEVING CALLS HELD AT ANOTHER STATION [HOLD PICKUP]

When a line is on hold and it appears on your keyset, press the **Line** button with the flashing indicator.

When a line is on hold and it does not appear on your keyset, dial **12** plus the line number or the extension number of the station that placed the call on hold.

NOTE: If the Hot Keypad feature has been turned off, you must first lift the handset or press the **Speaker** button before you begin dialing.

## CALL TRANSFER

Transfer is used to send any calls to another extension in one of two ways. You can do a screened transfer by informing the other extension who is calling or you can do a blind transfer without notification.

- While on a call, press the **Transfer** button and dial an extension number or group number. Your call is automatically put on transfer hold—**OR**—press a **DSS** button or station group button. Your call is automatically put on transfer hold.
- Hang up when you hear ringing (this is an unscreened or blind transfer)—**OR**—wait for the called party to answer and advise him/her of the call and hang up. If the transfer is refused, you will be reconnected to the outside line when the called station hangs up or you can press **Transfer** to return to the outside party.
- If you wish to send the call to another extension without waiting for the first station to hang up, simply press another **DSS** button—**OR**—press the **Call** button or C.O. line button to return to the outside party and begin the transfer process again.
- When you are transferring a call to a keyset set for Voice Announce or Auto Answer, the transferred call will always ring.

### NOTES:

1. After the inside party answers, you may alternate back and forth between the parties by pressing the **Transfer** button.
2. If you receive No More Calls tone, that station has no button available to receive another call. Press **Transfer** to return to the other party.
3. You cannot transfer an Intercom call by pressing a **DSS** button. You must press the **Transfer** button and dial the destination extension number.

## TRANSFER WITH CAMP-ON

When you are transferring a call to another station and you receive a busy signal, you may camp the call on to this station. Simply hang up when you hear the busy signal. The called party will be alerted that a call is waiting for them.

NOTE: If you receive No More Calls tone, that station has no button available to receive another call. Press **Transfer** to return to the outside caller.

## TRANSFER TO VOICE MAIL

This feature is used to send a call directly to a voice mailbox. Your keyset must have a correctly programmed **VT** button to accomplish this. To transfer a call directly to a voice mailbox:

- While on a call, press the **VT** button and dial the mailbox number.
- Hang up when dialing is completed.

## CALL WAITING

If an outside call has been camped-on to your phone or another station has camped-on to you:

- You will hear a tone in the earpiece and the call that is waiting for you (camped-on) will flash. In addition the bottom line of the display will indicate the number of the station or trunk party camped-on.
- Press the flashing button to answer; your other call will go on hold automatically if your station has the Automatic Hold feature set. If not, you must press **Hold** and then the flashing button—**OR**—finish the first call and hang up; the waiting call will ring.
- Lift the handset or press the **Speaker** button to answer.

NOTE: Intercom calls will not go on Automatic Hold. When using the speakerphone the camp-on tone will come through the speaker.

## CALL FORWARD OPTIONS

A display keyset may review or change call forward options and destinations. Call forward access can be done via the keypad or by accessing the keyset display features. To review or change call forward options:

- Press the **Menu** button, scroll to **Settings**, press the **OK** button.
- Scroll to **Call Forward** and press the **OK** button.
- Scroll to the desired Forwarding option, enter the destination extension, and press the Save soft button.  
—**OR**—
- Press **Transfer 102**.
- Dial **0-5** to select the forward type (e.g., 1)—**OR**—  
Press **Volume Up** [+] or **Volume Down** [-] to select the forward type  
Press the right soft key to move the cursor.
- Dial the destination number (e.g., **202**)—**OR**—  
Press **Volume Up** [+] or **Volume Down** [-] to select the destination and press the **Right** soft key to move the cursor.
- Dial **1** to set—**OR**—press **Volume Up** [+] or **Volume Down** [-] to select **Yes** or **No** and press **Transfer** to store and exit.  
—**OR**—

### To Forward ALL Calls to Another Station

- Dial **601** plus the extension or group number.
- Receive a confirmation tone and hang up.

### To Forward Calls to Another Station when you are on the Phone (BUSY):

- Dial **602** plus the extension or group number.
- Receive a confirmation tone and hang up.

### To Forward Calls to Another Station when you DO NOT ANSWER:

- Dial **603** plus the extension or group number.
- Receive a confirmation tone and hang up.

### When you have both Forward ON BUSY and Forward NO ANSWER Destination Programmed:

- You can activate them simultaneously.
- Dial **604**. Receive a confirmation tone and hang up.

### To Forward Calls when DND is Activated:

- Dial **605** plus the extension or group number.
- Receive a confirmation tone and hang up.

### To Forward Calls to the Station Where You Currently Are (FORWARD FOLLOW ME):

- Dial **606** plus the extension or group number.
- Receive a confirmation tone and hang up.

To clear all call forward conditions set at your station lift the handset and dial **600**.

## STATION CALL PICKUP

To pick up (answer) a call ringing at another station, lift the handset and dial **65** plus the extension number of the ringing phone. If you have a **DP** (Direct Pickup) key assigned with a station number, you only need to press this DP key with the flashing light to answer this ringing station. NOTE: If the Hot Keypad feature has been turned off, you must first lift the handset or press the **Speaker** button before you begin dialing.

## GROUP CALL PICKUP

To pick up (answer) a call ringing in any pickup group, lift the handset and dial **66** plus the desired group number (**01-10** on the **OfficeServ 7030**, **01-20** on the **OfficeServ 7200-S**, **01-99**, and **01-99** on the **OfficeServ 7000 Series**) or press the flashing **Group Pickup** button if available.

### NOTES:

1. A group pickup button can have an extender for a specific pickup group.
2. If the Hot Keypad feature has been turned off, you must first lift the handset or press the **Speaker** button before dialing the access code.

## MY GROUP PICKUP

If desired, a new access code can be assigned to pickup ringing calls in the same pickup group as you are in. Like "66" above except you do not need to dial the desired group number. See your installation company for the assigned access code. MY GROUP PICKUP: \_\_\_\_\_.

## PRIVACY RELEASE

This feature will allow another station to join in our conversation by releasing privacy on the C.O. from your phone.

**To Release Privacy:** While you are talking on a C.O. line and you wish to have other internal parties (or up to three) join the conversation.

- Press the **PRB** button (the **PRB** indicator will be steady). Inform the other party that he/she may now join the conversation.

After the other party (or parties) has joined the conversation and you wish to return privacy to the line so that no one else can join the conversation, press the **PRB** button a second time, the **PRB** button LED will be off.

**To Join a Non-Private Conversation:** When someone has informed you that you can join a conversation:

- Press the **C.O. line** button that he/she has indicated—**OR**—
- Dial the **C.O. line number** that he/she has indicated.



# DIALING FEATURES

All “DIALING FEATURES” instructions are written to support Overlap Dialing mode. This is the technical name for dialing from a telephone as it has been for many years. In recent years the cell phone industry has changed the cell phones to use Enblock Dialing. With this dialing mode all the digits are dialed and then sent to the carrier after pressing the **CALL** key. Please check your telephone setup to confirm what dialing mode is used.

## SPEED DIALING

You can dial a preprogrammed telephone number stored in the system-wide speed dial list of numbers 500–999 or from your personal list of numbers 00–49.

Your system may be set for 950 system wide numbers. If so the system speed dial access codes are 050~999 and the station speed dial codes are 000~049.

- From the idle screen with the handset on-hook, press the **AOM** soft button, scroll to the **Speed Dial** button, press the **OK** button or dial **16**.
- Dial the desired speed dial number.
- The telephone number is automatically dialed for you.

NOTE: If the Hot Keypad feature has been turned off, you must first lift the handset or press the **Speaker** button before you begin dialing.

## PROGRAMMING PERSONAL SPEED DIAL NUMBERS

You can program frequently dialed telephone numbers in a personal speed dial list. A station may be assigned up to fifty numbers, **00–49**. See your system administrator to determine the amount assigned to your station. The phone itself maintains 1000 station speed dial numbers.

- While on-hook, press **Transfer** and then dial **105**.
- Dial a speed dial number (**00–49**).
- Dial a line or line group access code.
- Dial the telephone number to be stored (24 digits maximum). It can include #, \*, FLASH and PAUSE.
- Press **Transfer** to store the number.

NOTE: If the Hot Keypad feature has been turned off, you must first lift the handset or press the **Speaker** key before you begin dialing.

For the purposes of programming speed dial numbers, the programmable buttons are known as **A, B, C, D, E,** and **F**.

- The **A** button is not used.
- The **B** button inserts a flash.
- The **C** button inserts a pause.
- The **D** button is used for pulse to tone conversion. If your system uses rotary (or pulse) dialing C.O. lines, pressing **D** while entering a speed dial number causes all subsequent digits to be sent as DTMF tones.
- The **E** button is used to hide digits. Display keyset users may want to hide some speed dial numbers so that they will not show in the display. When you are entering a telephone number, press **E**. All subsequent digits will be hidden. Press **E** again to begin displaying digits.
- The **F** button is used to enter a speed dial name or number. [See Personal Speed Dial Names under Display Features.](#)
- Use the **Hold** button to clear a speed dial number.



## DIRECTORY DIALING

- Press the **Func.** soft button, scroll to **Directory**, press **OK**.
- Press **Func.** soft button, scroll to the desired **directory**, press **OK**.  
**STATION DIRECTORY** - Accesses Station name directory.  
**PERSONAL DIRECTORY** - Accesses your personal speed dial name list.  
**SYSTEM DIRECTORY** - Accesses System speed dial name list.
- Enter the first letter of the desired party.
- Press the +/- buttons to scroll to the desired entry.
- Press the **Func.** soft button.
- Select the appropriate operation, press **OK**.  
**DIAL** - Dials the displayed number.  
**EXIT** - Exit programming and return to idle screen.  
**PREVIOUS** - Moves you to the previous entry.  
**NEXT** - Moves you to the next entry.
- Press **Back** to return to idle screen.

## LAST NUMBER REDIAL

To redial the last outgoing telephone number you dialed, press the **Func.** soft button, scroll to **Last Redial**, or dial **19**.

### NOTES:

1. If the Hot Keypad feature has been turned off, you must first lift the handset or press the **Speaker** button before you begin dialing.
2. Redial does not apply to intercom calls.

## SAVE NUMBER WITH REDIAL

To save the number you just dialed for later use, press the **Save/Repeat** button before hanging up.

To redial this saved number at any time, press the **Func.** soft button, scroll to **Save/Repeat**, press **OK** button or dial **17**. The same line will be selected for you.

### NOTES:

1. If the Hot Keypad feature has been turned off, you must first lift the handset or press the **Speaker** button before you begin dialing.
2. The saved telephone number is stored in memory until you save another number.
3. Redial does not apply to intercom calls.

## AUTOMATIC REDIAL/RETRY

When you are making an outside call and you receive a busy signal, the system can automatically redial the number for you. It will automatically redial at a pre-programmed interval for up to 15 attempts.

- When you hear a busy signal, press the **Retry** button.
- The system will reserve the line and automatically redial the same number for you. You will hear the call being made through the keyset speaker. The microphone is muted.
- When the called party answers, lift the handset or press the flashing **Speaker** to begin speaking.

### NOTES:

1. If you make another call, auto-redial is canceled.
2. To cancel an auto-retry, lift and replace the handset.

## PULSE TO TONE CHANGEOVER

When making an outside call on a dial pulse line, press **#**. All digits dialed after the **#** will be sent as tones.

# PAGING AND MESSAGING

## MAKING AN INTERNAL PAGE

To make an announcement through the keyset speakers in the idle condition:

- Lift the handset.
- Press the **Func.** soft button, scroll to **Page** button, press **OK** or dial **55**.
- Dial the desired zone number **0, 1, 2, 3** or **4**.
- After the attention tone, make your announcement.

### NOTES:

1. If you have a dedicated page zone button, it is not necessary to press **Page** and dial a zone number.
2. If allowed by your system administrator you may be able to initiate a page from a speakerphone by pressing the **Page** key or dialing **55** without lifting the handset.

## MAKING AN EXTERNAL PAGE

To make an announcement through the external paging speakers:

- Lift the handset.
- Press the **Func.** soft button, scroll to **Page** button, press **OK** or dial **55**.
- Dial the desired zone number **5, 6, 7** or **8**—**OR**—dial **9** to page all external zones.
- After the attention tone, make your announcement.

### NOTES:

1. If you have a dedicated page zone button, it is not necessary to press **Page** and dial a zone number.
2. If allowed by your system administrator you may be able to initiate a page from a speakerphone by pressing the **Page** key or dialing **55** without lifting the handset.

## ALL PAGE

To page all designated keysets in internal zone 0 and all external zones at the same time:

- Lift the handset.
- Press the **Func.** soft button, scroll to **Page** button, press **OK** or dial **55**.
- Dial **\*** or press the **All Page** button.
- After the attention tone, make your announcement.

#### NOTES:

1. The LED on the **Page** button will only light when an All Page is in progress.
2. If allowed by your system administrator you may be able to initiate a page from a speakerphone by pressing the **Page** key or dialing **55** without lifting the handset.

## MEET ME PAGE

- Lift the handset.
- Press the Meet Me Page (**MMPG**) button or dial **54**.
- Dial the desired zone number (0~9).
- After the attention tone, instruct the paged person to dial **56**.
- Press **Func.** soft button, then **Answer Wait**, then **OK** button.
- Remain off-hook until the person dials **56** from any phone.
- The paged person will be automatically connected with you.

## CALL PARK AND PAGE

When you have an outside call for someone who is not at his/her desk, you can park the call prior to paging. The OfficeServ 100, OfficeServ 500, and OfficeServ 7000 Series systems offer two different methods:

#### MANUAL PARK ORBITS

- While in conversation, press the **Park** button.
- Entered a desired orbit number (**0-9**), if the orbit number is busy dial another orbit number. Display users can press **\*** to automatically place the call in any available orbit number and see the number in the display.
- Remember the selected orbit number.
- Replace the handset when finished.
- Lift the handset and make a page announcement as previously described (example: "John Smith park two").

#### To retrieve a parked call from orbit:

- Press the **Park** button and dial the announced orbit number (**0-9**).
- You will be connected to the parked call.

#### NOTES:

1. You must have a **Park** button or park access code to retrieve and place calls in park orbits.
2. If the parked call is not retrieved within a pre-programmed period of time, it will recall your keyset and have a slow flashing amber light. You cannot park and page intercom calls.
3. If the Hot Keypad feature has been turned off, you must first lift the handset or press the **Speaker** button before you begin dialing.

#### AUTOMATIC PARK WITH PAGE BUTTON

- While in conversation, press the **Page** button. The call is automatically parked at your station.
- Receive page tone and dial a desired page zone number.
- Make announcement indicating your extension number or the line number. Hang up.

#### To retrieve an automatically parked call:

- Dial **10** plus the number that was announced. If you have a **PAGPK** button, press it and dial the number that was announced. If you have a **Park** button, press it and dial the announced orbit number.
- You will be connected to the parked call.

#### NOTES:

1. If the call is not retrieved within a pre-programmed period of time, it will recall your keyset and have a slow flashing amber light. You cannot park and page intercom calls.
2. If the Hot Keypad feature has been turned off, you must first lift the handset or press the **Speaker** button before you begin dialing.

## SETTING A MESSAGE INDICATION

When you are calling another station and no one answers or you receive a busy signal, you can leave a message indication:

- Press the **Func.** soft button, scroll to **Message**, press **OK—OR—dial 43** and receive confirmation tone. Hang up.
- The message button on the Main Programmable Button screen and the TSI will flash red at the called station.

#### NOTES:

1. A station can have up to five message indications.
2. If the Hot Keypad feature has been turned off, you must first lift the handset or press the **Speaker** button before you begin dialing.

## CANCELING MESSAGES

To cancel a message indication that you left at another station, dial **42** plus the extension number of the station at which you left a message.

To cancel all message indications left at your keyset, dial **42** plus your extension. Your **Message** button indicator will stop flashing and the TSI will go out.

NOTE: If the Hot Keypad feature has been turned off, you must first lift the handset or press the **Speaker** button before you begin dialing.

—OR—

- Press **Message** button, scroll to **Station Messages**, press **OK**.
- Press **Func.** soft button, scroll to **Clear**, press **OK**.

## RETURNING MESSAGES

- Press **Menu**, scroll to **Message**, press **OK**, scroll to **Station Message**, press **OK**, press **Func.** soft button, press **Reply**, and then press **OK**, or dial **43**. The first station that left a message will be called automatically. If that station does not answer, the called station **Message** button indicator will continue to flash and the TSI will stay on.
- Repeat until all messages have been returned in the order received.
- Your **Message** button indicator will stop flashing and the TSI will turn off when all messages have been returned.

NOTES:

1. Display keyset users can view message indications and return them in any order. [See Viewing Message Indications under Display Features.](#)
2. If the Hot Keypad feature has been turned off, you must first lift the handset or press the **Speaker** button before you begin dialing.
3. If a message has been left at your keyset by a keyset in Auto Answer, you must manually cancel the message after it has been returned.

## PROGRAMMED MESSAGES

When you will be away from your phone for any length of time, you can leave a programmed station message. Display stations calling you will see this message and be informed of your status or follow your instructions.

- Dial **48** plus any of the message codes (**01–20**) listed on the back of this user guide.
- To cancel any of these messages you might have selected, dial **48** plus **00**.
- Press **Transfer** to exit and store your selection.

NOTE: If the Hot Keypad feature has been turned off, you must first lift the handset or press the **Speaker** button.

You can have multiple programmed message buttons (**PMSG**) and each one can have a different message code:

- Press any programmed message (**PMSG**) button. The message is set and the PGM MSG button indicator will be lit steady. Press the button again to turn off the programmed message and the indicator will go blank.
- Pressing another programmed message (**PMSG**) button will turn the previous one off and set a different programmed message.

# CONVENIENCE FEATURES

## LOGGING IN AND OUT

If enabled, your SMT-i5220 telephone may require you to log in before making or receiving calls. In these cases your telephone system administrator will provide you with an extension number, password, and the feature code used to log out.

**To log in:**

- At **Extension Login Screen** enter your ID which is your extension number.
- Scroll down to the password field and enter your station password
- Press on **Save** soft button or **OK** button.

**To log out:**

- Dial the feature code provided by your administrator (for example 77).

## DO NOT DISTURB

Use this feature when you want to block calls to your keyset.

- While on-hook, press the **Func.** soft button, scroll to **DND**, press **OK**, press **1** to turn it **ON**, or dial **401**. The **DND** button indicator will be lit steady to remind you of this mode.
- To cancel **DND**, press the **Func.** soft button, scroll to **DND**, press **OK**, press **0** to turn it **OFF**, or dial **400**. The **DND** button indicator goes blank. You can make calls while in the DND mode.

NOTES:

1. If the Hot Keypad feature has been turned off, you must first lift the handset or press the **Speaker** button.
2. If you place your keyset in **DND** mode and you do not have a **DND** button, your **Telephone Status Indicator** button will fast flash red to indicate DND status.
3. The **Selector Switch** can also be used to set DND.

## ONE TIME DND

If you are on a call and you do not wish to be interrupted while on that call, you can press the **DND** button and place your station in Do Not Disturb. When you hang up at the end of the call, DND will be automatically canceled and your keyset will be able to receive new calls. This feature requires a **DND** button.

## MUTE

You can mute the handset transmitter or the microphone during any conversation:

- Press the **Mute** button. The **Mute** button indicator will be lit steady.
- To resume speaking, press the **Mute** button again. The **Mute** button indicator goes blank.

## BACKGROUND MUSIC

When a music source is supplied, you may listen to music through the speaker in your keyset:

- While on-hook, press the **Hold** button to hear music.
- Press the **Hold** button again to turn music off.

You can set the level of background music by using the **Volume** buttons while listening to the music. This does not affect the speakerphone level.

## ESTABLISHED CALL PICKUP

To pick up an established call in progress at a single line extension connected to a computer modem on your PC.

- Press the **EP** button for that station on your keyset and the call is automatically moved to your keyset.
- The single line extension on your modem will be disconnected.

NOTE: You must have an assigned (**EP** button) button on your regular keyset, for the single line station.

## ANSWERING THE DOOR PHONE

When you are programmed to receive calls from a door phone:

- You will receive three short rings repeated.
- Lift the handset. You are connected to the door phone.
- If an electric door lock release is installed, dial **13** to unlock the door.

## CALLING THE DOOR PHONE/ ROOM MONITOR

You may call the door phone and listen to what may be happening outside or in another room.

- Dial the extension number of the door phone.
- You will be connected to the door phone and you can listen or have a conversation.
- If an electric door lock release is installed, dial **13** to unlock the door.

NOTE: If the Hot Keypad feature has been turned off, you must first lift the handset or press the **Speaker** button.

## EXECUTIVE/SECRETARY [HOT LINE]

If programmed, an executive boss and a secretary can have a hot line between them. When the executive station is in the DND mode, all of its calls will ring the secretary station. If the secretary does not answer, the caller will go to the secretary's voice mail box if setup.

When an Executive/Secretary hotline is programmed to this keyset, the keyset offers an additional screen option. This screen has options for setting the status of the keyset user. This status update is viewable to EasySet users only.

- Either person can press the **Boss** button to make a voice call to the other station.
- Using the hot line will override DND at the other station. This button will have a flashing indication when the other station is in use.

### To transfer a call to a Boss in DND:

- Press the **Boss** button.
- Wait for the **Boss** to answer, then announce the call and hang up to complete the transfer—**OR**—hang up to complete a blind transfer.

### Executive/Secretary (Messaging):

When the Boss or Secretary is needing to inform the other party of their current status, they can send a message to their display.

- Press the **Func.** soft button. Scroll to **EXE/SECR MSG** and press **OK**.
- Select and highlight one of the **Return On** messages and press the **Edit** soft button.
- Press and hold the **Delete** soft button to erase the default message.
- Using the dial pad, type in the new message ([refer to Text Input Method](#)).
- When finished press the **Save** then the **Send** soft button to display the message on the other (Boss/Secretary) phone.

## GROUP LISTENING

When you are engaged on a call and you are using the handset, you may want other people to hear the distant party's voice over the speaker:

- Press the **Listen** button to turn on the speaker. The microphone is not in use, so the distant party does not hear other parties present in your office.
- Press **Listen** again to turn the speaker off and resume private conversation.
- Repeat if necessary.

NOTE: Depending on speaker volume and the acoustics of your office, it may be advisable to turn the group listening feature off before hanging up. This will eliminate a momentary squeal.

## ACCOUNT CODES

When enabled, your system allows calls to be charged to different accounts. You can enter account codes either by dialing the full code, by entering an account code "**bin number**", or by pressing your **ACC (Account)** key if one is assigned. Bin numbers are a 3 digit short code that will automatically insert the appropriate account code. Account codes may be a maximum of 12 digits (# may be used); if the account code is to be less than 12 characters you may end the code by pressing \* or the right soft key. The type of code used is determined by your telephone system administrator. Codes can be entered before or during a call as follows:

### To enter an account code before placing the call:

- Press your **ACC (Account)** key or dial **47**.
- Dial the account code or bin number.
- You will receive a confirmation tone and display.
- When prompted dial a trunk or trunk group (i.e. 9) and the telephone number to call.

### To enter an account code by interrupting the conversation:

- While on an outside call press the **ACC (Account)** key or press **Transfer** followed by **47**.
- Dial the account number or bin number (if you are entering an account code you will need to press your **ACC (Account)** key or right soft key to finalize the entry)

NOTE: If you make an error simply repeat the procedure with the correct code. Only the most recent account code dialed will be recorded.

## LOCKING YOUR KEYSSET

You can lock your keyset to control misuse of your phone while you are away. You can unlock it when you return.

- Press **Menu** button, scroll to **Phone**, press **OK**.
- Scroll to **Security** option. Press **OK**.
- Enter the **Password** [Default Password is "1234"]. Press **OK**.
- There are three options available:

**CHANGE PASSWORD:** This can be used to change the station password.

**DIAL:** Allows the station user the option to select **Lock All**, **Lock Outgoing**, or **Unlocked**.

1. **UNLOCKED** - No restrictions. User may complete internal and outside calls.
2. **LOCK OUTGOING** - Restricted to incoming calls only. No outside calls can be made. When 911 is programmed, 911 emergency dialing is allowed.
3. **LOCK ALL** - No calls, incoming or outgoing allowed to or from the set.

**PHONE MODE:** Allows the user to lock or unlock the menu from being changed at the station.

- Use the navigation soft button to scroll **Left/Right** to choose the desired mode.
- Press the **OK** button.
- Press the **Back** soft button to return to **Menu**, and press **Back** soft button again to return to idle screen.

## MANUAL SIGNALLING

Use this feature when you want to send a brief 500ms ring burst to another station, regardless of the status of your phone (on-hook, off-hook, handsfree, DND, or ringing).

### To send a signal to another station:

- Press the Manual Signalling (**MS**) button.
- You may press the **MS** button repeatedly to send multiple signals to the designated station.

NOTE: Your phone must have a Manual Signalling (MS) button with a station number extender assigned to it. Manual Signalling will override DND.

## OFF-HOOK VOICE ANNOUNCE

Keysets may receive a voice announcement while on another call. The calling station must have an **OHVA** button. When you are in DND, you cannot receive OHVA calls. The OHVA feature will work with intercom and transferred calls.

When you receive an OHVA and secure OHVA is ON, you will hear the announcement in the handset receiver, if you are using the handset. If secure OHVA is OFF then you will hear the announcement on the speaker, if you are talking on the handset. If you are using the speakerphone the announcement will always be heard through the speaker.

### To make an off-hook voice announcement:

- Dial the extension number or press the **DSS** button.
- When you receive a busy signal, press the **OHVA** button.
- After the attention tone, begin speaking.
- Finish the call by replacing the handset.
- Press the flashing **Call** button on your keyset. This will place the original party on hold and allow you to talk to the announcing party.
- To return to your first party, press the button corresponding to your original call. This will disconnect the OHVA call.

### NOTES:

1. When you are voice announcing to a station close to you, use the handset to avoid an echo effect.
2. You cannot off-hook voice announce to single line telephones.

## OHVA BLOCK

Your keyset can be programmed with an OHVA Block (**Block**) button. Pressing this button will prevent anyone from making an OHVA to you until you press the button again and cancel the blocking.

## OHVA REJECT

Your keyset can be programmed with an OHVA Reject (**Reject**) button. Pressing this button while receiving an OHVA call will disconnect the voice announcing party and return you to your original call.

## IN GROUP/OUT OF GROUP

If your keyset is assigned to a station ring group, you can remove your keyset from the group and then put it back in. While you are out of the group, you can receive calls to your extension number but not calls to the group number. If you have an **IO GRP (IN/OUT GRP)** button with the group number assigned.

- Press the **IO GRP (IN/OUT GRP)** button. The button indicator will be lit steady when your keyset is in the group.
- Press the **IO GRP (IN/OUT GRP)** button again to exit the group and the indicator will go blank. Repeat as necessary.

If you do not have an **IO GRP (IN/OUT GRP)** button:

- Dial the **IO GRP (IN/OUT GRP)** access code number \_\_\_\_\_, then the group number, then **0** to exit the group or **1** to enter the group.

NOTE: If the Hot Keypad feature has been turned off, you must first lift the handset or press **Speaker** button.

The **IO GRP (IN/OUT GRP)** button can include an extender to indicate the specific group that this button will affect. This means that if you are in multiple groups, you can decide for which groups you will receive calls.

# CUSTOMIZING YOUR KEYSSET

## AME PASSWORD

This feature allows customers using the AME feature to enable password protection. This will prevent unauthorized users from listening to your messages being left. The passcode is the same as your station passcode. This feature only applies if there is a Samsung Voicemail card installed in the system and your keyset has a programmed AME button.

- With the handset on-hook, press **Transfer** and then dial **110**.
- Dial **101** to turn on AME PASSCODE or **100** to turn it off.
- Press **Transfer** to store your selection.

## AUTO CAMP-ON

This option allows intercom calls to be automatically camped on, if possible, when a busy station is called.

- With the handset on-hook, press **Transfer** and then dial **110**.
- Press **081** to turn CAMP-ON on or **080** to turn it off.
- Press **Transfer** to store your selection.

## SELECT RING TONE

Each SMT-i5220 user can select from a variety of ring tones.

### From the LCD:

- Press **Menu** button, scroll to **Phone**, press **OK**.
- Scroll to **Sound** option and press **OK**.
- Select **Ring Tone** and press **OK—OR—**you may dial **1** and immediately enter the option.
- Use **Navigation** button to scroll through the available ring tones and press **OK** or **Save** soft button to store your selection.
- Press **End** soft button to return to idle screen.

## CHANGE YOUR PASSCODE

From the factory, your station passcode is 1234. You can change your station passcode whenever you desire.

- While on-hook, press **Transfer** and then dial **101**.
- Dial your old passcode.
- Dial a new passcode (must be four characters). You can use **0–9**.

- Redial the new passcode. If successful, you will hear two beeps. Four beeps indicate an incorrect code to confirm, reenter the code again.
- Press **Transfer** to store the new passcode.

## SET ANSWER MODE (INTERCOM)

You can receive internal calls in one of three modes ([see Answering Intercom Calls under Intercom Calls](#) for descriptions).

- While on-hook, press **Transfer** and then dial **103**.
- Dial **0** for Ringing, **1** for Auto Answer or **2** for Voice Announce.
- Press **Transfer** to store your selection.

NOTE: When your keyset is programmed for Voice Announce and you have Forward No Answer (FNA) turned on, you must answer screened transfers by pressing the **OK** button before your FNA timer expires or the call will forward.

## SET ANSWER MODE (CO)

Your incoming CO calls can be set to follow the intercom answer mode.

- While on-hook, press **Transfer** and then dial **110**.
- Dial **15** to access **AUTO ANS CO**.
- Press the **Volume Up** [+] or **Volume Down** [-] key to change status (**On/Off**).
- Press **Transfer** to store your selection.

## AUTOMATIC HOLD

While on an outside call, pressing a line button, route button or a flashing **Call** button will automatically put your call on hold and connect you to the next call. This feature can be turned on or off at your keyset.

- With the handset on-hook, press **Transfer** and then dial **110**.
- Dial **001** to turn Automatic Hold on or **000** to turn it off.
- Press **Transfer** to store your selection.

## HEADSET OPERATION

Keyset users can switch between headset mode and handset mode. When using headset mode, press the **Speaker** button to answer and **Speaker** button to release calls.

- With the handset on-hook, press **Transfer** and then dial **110**.
- Dial **021** to use the headset or **020** to use the handset.
- Press **Transfer** to store your selection.

Your keyset is equipped with a **Headset** button. Pressing this button while the indicator is off will cause the keyset to enter headset mode and the button indica-



tor to be lit solid to indicate this. Pressing the button while the button indicator is lit solid will cause the keyset to return to handset mode and the button indicator will go off.

NOTE: If you need to switch between headset mode and handset mode (or speaker phone) during a conversation, you will need to put the call on hold first.

## HOT KEYPAD

On your phone system your keyset's keypad can be made "live" or "hot" so that it is not necessary to lift the handset or press the **Speaker** button before you begin dialing. Calls can be made and features activated by simply dialing the C.O. line number, trunk group access code, intercom number or feature access code.

- With the handset on-hook, press **Transfer** and then dial **110**.
- Dial **031** to turn the Hot Keypad on or **030** to turn it off.
- Press **Transfer** to store your selection.

## KEY CONFIRMATION TONE

You can hear a short beep (confirmation tone) each time you press a button on the dial pad. This tone can be turned on or off.

- While on-hook, press **Transfer** and then dial **110**.
- Dial **040** to turn tones off or **041** to turn tones on.
- Press **Transfer** to store your selection.
- Additional ring tones can be selected from the **Menu, Phone, Sound, Keytone** option.

## REJOINING A PAGE

This feature allows you to hear the remaining portion of an ongoing internal page after you return your keyset to idle. To enable this feature:

- With the handset on-hook, press **Transfer** and then dial **110**.
- Dial **051** to turn this feature on or **050** to turn it off.
- Press **Transfer** to store your selection.  
—OR—
- Press the **Menu** button, scroll to **Phone**, press **OK**.
- Scroll to **Sound** and press **OK**, scroll to **Keytone**, and press **OK**.
- Using the **Navigation** button scroll to **Select New Ring Tone**, press **Save** soft button.

## RING PREFERENCE

This feature automatically answers ringing calls when you lift the handset or press the **Speaker** button. This method will always answer calls in the order they arrived at your keyset. When you turn ring preference off, you must press the flashing button to answer a call, allowing you to answer calls in the order you choose.

- With the handset on-hook, press **Transfer** and then dial **110**.
- Dial **061** to turn ring preference on or **060** to turn it off.
- Press **Transfer** to store your selection.

## DISPLAY SPEED DIAL NAME

This option allows you to view the name associated with a speed dial number as it is dialed.

- With you handset on-hook, press **Transfer** and then dial **110**.
- Press **111** to turn **DISP SPDNAME** on or **110** to turn it off.
- Press **Transfer** to store your selection.

## CALLER ID REVIEW ALL

This feature allows display keyset users to review Caller ID information for calls sent to their stations. This list can be from ten to fifty calls in a first in, first out basis. The list includes calls that you answered and calls that rang your station but that you did not answer. When reviewing this list, you can press one button to dial the person back. The system must be using LCR to dial the stored number.

- With you handset on-hook, press **Transfer** and then dial **110**.
- Press **121** to turn **CID Review All** on or **120** to turn it off.
- Press **Transfer** to store your selection.

## SECURE OHVA

This option allows you to receive OHVA (Over Head Voice Announce) calls via the speaker while you are on the handset.

- With your handset on hook, press **Transfer** and then dial **110**.
- Press **131** to turn **SECURE OHVA ON** or **130** to turn it **OFF**.
- Press **Transfer** to save your selection.

## CONFIGURE MOBILE EXTENSIONS [MOBEX]

This feature allows you to configure options for any Mobile Extension (MOBEX) ports that are assigned to you by your telephone system administrator. You can turn a port on or off; set the telephone number for the port; or set the caller ID you will be calling in from. The caller ID field has no effect unless you have been author-

ized as an Executive MOBEX user. Check with your telephone system administrator for further details on your specific system configuration.

#### To set the phone number a MOBEX port can reach you on:

- Press **Transfer** and then dial **126**.
- Dial your station pass code.
- Dial the number of the port you wish to configure (1-5) (you may also use the **Volume Up** [+] or **Volume Down** [-] keys to select a port and press the right soft key to confirm).
- Press **Right** soft button to move to telephone number.
- Dial the number of a C.O. line or trunk group to use when making calls to this MOBEX port.
- Dial the phone number you can be reached at by users calling this MOBEX port.
- Press **Transfer** to store your selection and exit programming.

#### To set the caller ID of the location you will be calling in from:

- Press **Transfer** and then dial **126**.
- Dial your station pass code.
- Dial the number of the port you wish to configure (1-5) (you may also use the **Volume Up** [+] or **Volume Down** [-] keys to select a port and press the **Right** soft key to confirm).
- Press **Right** soft button twice.
- Dial the contact number.
- Press **Transfer** to store your selection and exit programming.

#### To turn a MOBEX port ON or OFF:

- Press **Transfer** and then dial **126**.
- Dial your station pass code.
- Dial the number of the port you wish to configure (1-5) (you may also use the **Volume Up** [+] or **Volume Down** [-] keys to select a port and press the right soft key to confirm).
- Dial **2** to select the activation status option.
- Dial **0** to turn the port on, dial **1** to turn the port off.
- Press **Transfer** to store your selection and exit programming.

## DISPLAY FEATURES

### DIRECTORY INFORMATION

An 11 character directory name can be assigned to each extension number. Display keyset users can view the name of the called or calling station before answering.

Each outside line can have an 11 character directory name. Incoming calls can be easily identified and answered with different greetings.

Outside and internal calls ringing to a station group will display [CALL FOR xxx] where xxx is the station group number. This allows you to answer calls directed to you differently than calls directed to your group.

### DISPLAY NUMBER DIALED

Display keysets begin showing digits as they are dialed. They will stay in the display until the call duration timer comes on automatically or the **Timer** button is pressed. If the call duration timer is not used, the number dialed will be displayed until the call is released, transferred or put on hold.

### CALL DURATION TIMER

The system can be set to automatically time outside calls. A few seconds after you dial a telephone number, the timer appears in the display. It appears immediately for incoming calls. The call timer continues for the duration of the call. Call duration times are displayed in minutes and seconds. If a call lasts longer than 60 minutes, the timer restarts.

You can press the **Timer** button to manually begin timing a call. Press it again to stop timing. If you press it while the automatic timer is on, the call duration time is restarted.

### AUTO TIMER

Display keyset users may have the timer automatically start when they answer incoming calls or after a short delay on an outgoing call.

- With the handset on-hook, press **Transfer** and then dial **119**.
- Dial **41** to turn the auto timer on or **40** to turn it off.
- Press **Transfer** to store your selection.

## TIMER FUNCTION

Display keyset users may use this feature as a simple stopwatch.

- When the keyset is idle, press the **Timer** button to start timing.
- Press the **Timer** button again to stop timing.
- Read the elapsed time in the display.
- Lift the handset and replace it. The display will return to date and time.

## VIEWING STATION MESSAGE INDICATIONS

You can view all of your message indications before you return them:

- With the handset on-hook, press the **Message** button with the flashing indicator.
- The first station that left a message indication will be displayed.
- Press the **Volume Up** [+] or **Volume Down** [-] keys to scroll through the stations that left message indications. Use the soft keys to reply, clear or advance to the next message.
- Press the **End** button to return your keyset to the idle condition.

## PERSONAL SPEED DIAL NAMES

Each personal speed dial number can have an 11 character name assigned to it. This name is used to select the speed dial bin when you are dialing by directory.

- Press **Transfer** and then dial **106**.
- Dial the speed dial bin number **00–49**.
- Using the dial pad, enter the station name ([See Station Names](#)).
- Press the **Transfer** button to store the speed dial name.
- Repeat for each speed dial bin if necessary.

NOTE: Use the Navigation button to move the cursor left or right, and use the **Volume Up** [+] or **Volume Down** [-] buttons to increment the speed dial bins.

[See Programming Personal Speed Dial Numbers Section.](#)

## STATION NAMES

- With the handset on-hook, press **Transfer** and then dial **104**.
- Enter the **Station Name**. Use the **Volume Up** [+] or **Volume Down** [-] buttons to move cursor.
- Press **Transfer** to store the name.  
—OR—
- Press **Menu** button, select **Settings**, press **OK**.
- Select **Application Set.**, press **OK**.
- Select **Phone Name**, press **OK**.

- Enter **Station Name**. Use the **Volume Up** [+] or **Volume Down** [-] buttons to move cursor.
- Press **Save** soft button and then **End** soft button to store the name.

## MANAGING PROGRAMMABLE KEY ASSIGNMENTS

You can manage your key assignments for easy one touch operation of frequently used features.

- While on-hook, press **Transfer** and then dial **107**.
- Use the **Volume Up** [+] or **Volume Down** [-] buttons to scroll through all of your programmable buttons.
- Press **Transfer** to exit programming.

To program the programmable keys, press **Menu, Settings, AOM Setting**.

For example:

**If you want to press a key that will direct calls to Joel at extension 3201.** Select an empty key and set the following:

- Feature: DSS
- Ext. Number: 3201
- Display Name: Joel

**If you want to press a key that will direct calls to Sue's external phone number at 972-444-3456.** Select an empty key and set the following:

- Feature: Speed
- Ext. Number: 01
- Display Name: Sue
- Use Transfer 105 to set speed dial number: [xxxx] SPEED DIAL  
01: 9-9724443456

Please consult your installation company to requested a complete list of descriptions for any keys you may have programmed on your keyset.

NOTE: Confirm that the cursor is placed correctly before you enter the extender.

## BACKSPACE WITH LCR

If you misdial while using LCR, you can delete digits shown in the display by pressing the **Backspace** soft key as many times as necessary or by pressing **Clear** to delete all.

# CALLER ID

## SELECTING YOUR CALLER ID DISPLAY

Simultaneous display of Caller ID name and number on incoming CO calls on both lines of display keysets is supported on all OfficeServ systems. On Transferred CO calls, you can decide if you want to see the Caller ID name or Caller ID number in the display. Regardless of which data is selected, you can press the NND button to view the other pieces of Caller ID information. To select the type of Caller ID information you wish to view:

- With the handset on-hook, press **Transfer** and then dial **119**.
- To set the first line of a ringing call display dial **0**.
- To set the second line of a ringing call display dial **1**.  
Set the data to display from the following:
  - To show nothing dial **0**.
  - To show Caller ID Number dial **1**.
  - To show Caller ID Name dial **2**.
  - To show the DID Number the call came in on dial **3**.
  - To show the Name of the DID the call came in on dial **4**.
  - To show the Name of the Group the call came in for dial **5**.
  - To show the DID Number and then Name of the DID dial **6**.
  - To show the Name of the DID and then the DID Number dial **7**.
- To set the top line of the display shown after answering a call dial **2**.  
Set the data to display from the following:
  - To show Caller ID Number dial **0**.
  - To show Caller ID Name dial **1**.
  - To show the DID Number the call came in on dial **2**.
  - To show the Name of the DID the call came in on dial **3**.
  - To show Caller ID Number and then the DID Number dial **4**.
  - To show Caller ID Name and then the DID Number dial **5**.
  - To show the DID Number and then the name of the DID dial **6**.
  - To show the Name of the DID and then the DID Number dial **7**.
  - To show the C.O. line information dial **8**.
- To set the format if the C.O. line information when the above is set to show C.O. line information dial **3**.
  - To show the C.O. line number and the dialed or Caller ID Number dial **0**.
  - To show only the dialed or Caller ID Number dial **1**.
- Press **Transfer** to exit and store your selection.

## VIEWING THE NEXT CALLER ID CALL

In the event that you have a call waiting or a camped-on call at your keyset, you can press the **Next** button to display the Caller ID information associated with the call in queue at your keyset. Either the CID name or CID number will show in the display depending on you Name/Number selection.

To view Caller ID information for calls that have been camped-on to your keyset, press the **Next** button.

## INQUIRE CALLER ID PARK/HOLD INFO

If you are informed that an incoming call is on hold or has been parked for you, you may view the Caller ID information before you retrieve the call. This may influence how you choose to handle the call.

### From an idle keyset:

- Press the **Inquire** button—**OR**—press **CID** button, then **Func.** soft button, and the **Inquire** soft key.
- Dial the trunk number.
- You may now answer the call by pressing the **ANS** button—**OR**—you may use **Func.** soft button and **NND** to view more information about this call—**OR**—you can return to the idle condition by pressing **Ignore**.

### If you are on a call:

- Press the **Func.** soft button and then **Inquire** button. Your existing call will go on hold—**OR**—press the **CID** button and **Func.** soft button then **Inquire** soft button to place the first call on hold.
- Dial the trunk number.
- You may now answer the call by pressing the **Func.** soft button then the **ANS** button—**OR**—you may use **NND** to view more information about this call—**OR**—you can return to the idle condition by pressing the **Func.** soft button and then **Ignore**.

### NOTES:

1. If you are on an intercom call or you have Automatic Hold turned off, you must finish the existing call or place it on hold before inquiring.
2. If you inquire about an outgoing call, you will receive a [call no longer available] display.
2. Your system must have LCR correctly programmed to allow you to **Dial** numbers from the review list or to **Store** entries from the review list.

# FEATURE ACCESS CODES

## Paging Zones - Dial 55 plus

- 0 \_\_\_\_\_
- 1 \_\_\_\_\_
- 2 \_\_\_\_\_
- 3 \_\_\_\_\_
- 4 \_\_\_\_\_
- 5 \_\_\_\_\_
- 6 \_\_\_\_\_
- 7 \_\_\_\_\_
- 8 \_\_\_\_\_
- 9 All External Zones
- \* All Page

## Feature Access Codes

0	Operator	56	Meet Me Answer
10 + xxx	Pick Up A Parked Call	600	Cancel All Call Forward
12 + xxx	Pick Up a Held Call	601 + xxx	Set Forward All Calls
13	Door Lock Release	602 + xxx	Set Forward Busy
16 + xxx	Speed Dialing	603 + xxx	Set Forward No Answer
17	Save And Redial Number	604 + xxx	Set Forward Busy/No Answer
18	New Call (Recall)	605 + xxx	Set Forward on DND
19	Last Number Redial	606 + xxx	Set Forward Follow Me
400	Cancel Do Not Disturb	65 + xxx	Pick Up Ringing Extension
401	Do Not Disturb	66 + xx	Pick Up Group
42 + xxx	Cancel Sent Message	67	Universal Answer
43	Return Message	*	Authorization Code
44	Callback		
45	Busy Station Camp-On		
46	Conference		
47	Account Code		
48 + xx	Cancel Programmed MSG		
49	Send Flash to C.O. or PBX		
53 + xxx + 1	In Group		
53 + xxx + 0	Out of Group		

# SECTION 6. APPLICATIONS

# Samsung Voicemail

This section describes how to setup and use the various features available to a Subscriber. A Subscriber is a person that has been authorized access to the various features and services available in the Samsung Voicemail. Please review this section carefully before you use your Authorized Features and Services, known as Subscriber Services.

Voice Mail is one of the Subscriber Services available. Your voice mail box has the capability of storing private messages, and offers a number of options for sending or redirecting messages as well as provides several ways to notify you of new messages.

Another very common Subscriber Service is Access Manager. This allows you control over when and where you receive your calls as well as what to speak to your callers in the event you are unable to speak to them directly. The 'events' are referred to as "Call Conditions". No-Answer, Busy, and Blocked are the most commonly used Call Conditions.

This guide can be used by Subscribers from within the office or from telephones outside the office. The basic operation is the same, but the access method will be different. [See the Subscriber Services Menu Diagram for more details.](#)

Note that some features and prompts detailed here may not be available to all Subscribers. See your System Administrator if you have questions about feature availability.

## ACCESSING YOUR MAILBOX

*[Also known as Subscriber Services Menu]*

### Inside Callers *[Subscriber logging in from their Desk]*

- Dial the voicemail access number or press the key assigned to ring voicemail [VMMSG].
- Enter your personal password when prompted (the default password is 0000).

### Outside Callers *[Subscribers calling from Cell Phones or outside of the office environment]*

- Dial the phone number that will be answered by the voicemail. The main greeting will answer.
- At the main greeting dial [#] plus your Subscriber (or mailbox) number (Subscriber and Mailbox numbers will usually match your extension number).
- Enter your personal password when prompted (the default password is 0000).

### Access your Subscriber Services (or Mailbox) from a Station other than your Own (or checking a mailbox associated with a different station)

- Press the [VMMSG] key or dial the voicemail **group number**. You will be prompted to enter a password.
- Press [\*]. This will take you to the Main Auto Attendant Menu.
- Press [#] plus the Subscriber number of your choice. You will be prompted to enter your password.

At this point the inside and outside callers follow the same instructions. You will hear a message stating the number of messages left in your mailbox. You will then hear the Subscriber Services Menu with the following options:

- 1 Listen to New Messages - [See Listening to your Message.](#)
- 2 Record and Send Message - [See Sending Messages.](#)
- 3 Review Saved Messages - [See Listening to your Message.](#)
- 4 Access Manager - [See Access Manager.](#)
- 5 Personal Greetings - [See Personal Greetings.](#)
- 6 Mailbox Administration - [See Mailbox Administration.](#)
- # Personal Services - [See Personal Services.](#)
- \* Return to Main Menu.

**Voicemail and the Function Soft button:** When accessing and retrieving voice-mails from the mailbox, the service options such as **(1) Listening to Messages**, **(2) Record and Send Messages**, and **(3) Review Saved Messages** are available and can be accessed through the dial pad or through the **Function** soft key. When pressing the function soft button the options will be displayed. Scroll to and press the **OK** button to select an option from the **Function Menu**.

# Subscriber Services Menu

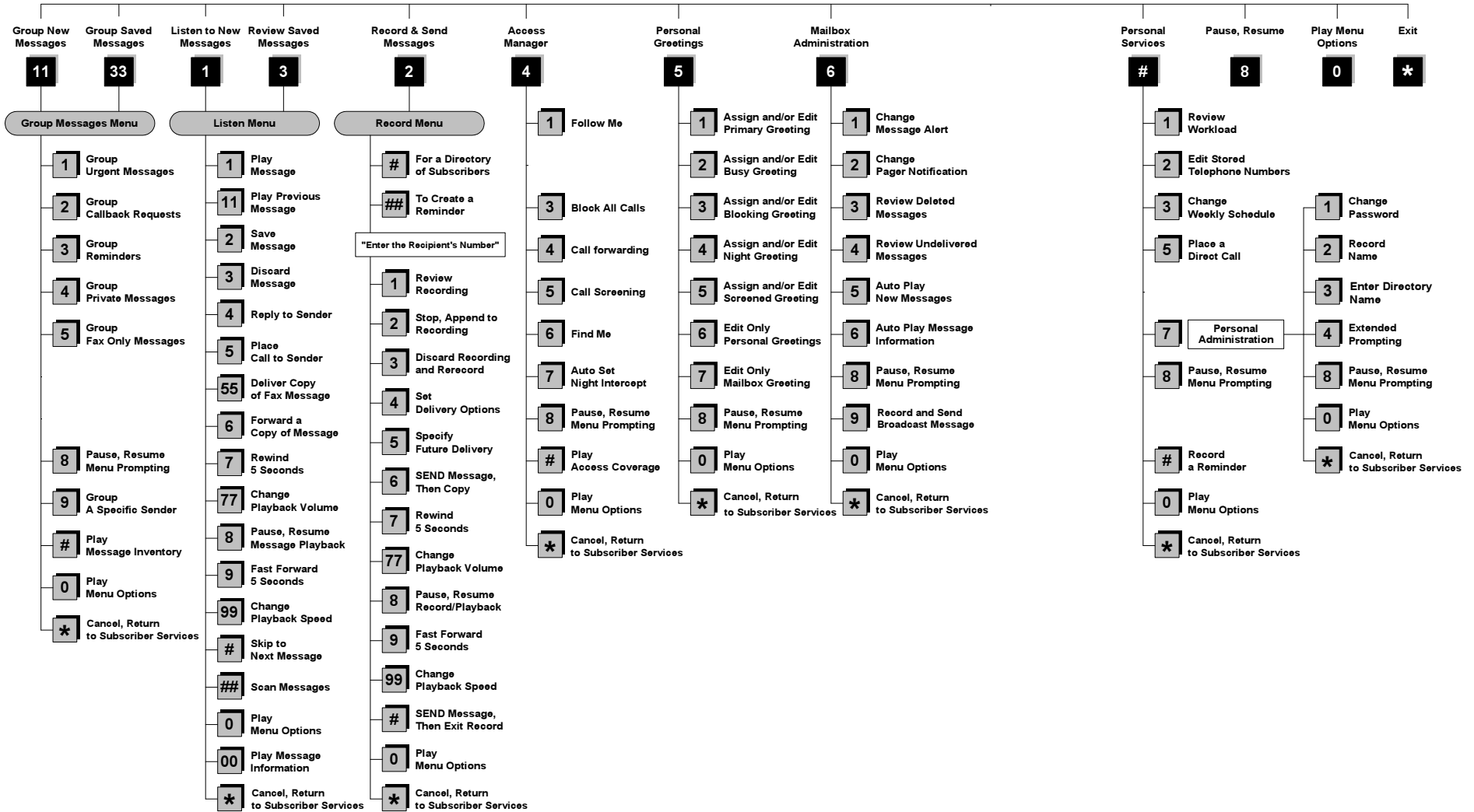

NOTE: All options shown MAY NOT be authorized. If an option is not available please speak to your system administrator.

\*Change Playback Speed and Volume not available on the OfficeServ 7030, OfficeServ 7100, OfficeServ 7200-S or OfficeServ IP-UMS.

## GETTING STARTED

Using your new Samsung Voicemail Subscriber Services is as simple as following a few simple spoken instructions. First time users should read this section as a tutorial. You should start with the following steps:

- Access your Subscriber Services Menu - You already know how to do this.

### From the Subscriber Services Menu:

- Record a Primary/No-Answer Personal Greeting. Dial **[5][1]**.
- Record a Mailbox Greeting. Dial **[5][7]**.
- Change your access code (Password). Dial **[#][7][1]**.
- Record your name. Dial **[#][7][2]**.
- Enter your directory name. Dial **[#][7][3]**.

After you have completed the steps above your Subscriber Services are set up and ready to use.

## LISTEN TO YOUR MESSAGES

If there are new messages in your mailbox your **[VMMMSG]** key will be lit. Call the Samsung Voicemail by pressing this key, and when prompted enter your password. You will then be at the Subscriber Services Menu. Select **[1]** to listen to new messages or **[3]** to listen to saved messages.

Note: After you enter your password, if "Autoplay of New Messages" is enabled and you have new messages the Samsung Voicemail will begin to play them automatically. A subscriber can control this feature. From the Subscriber Services Menu **[6][5]** toggles "Autoplay of New Messages" ON/OFF.

## SUBSCRIBER SERVICES MENU

The following is a list of all the options available in the Subscriber Main Menu.

- 1** LISTENING TO NEW MESSAGES
- 11** GROUP NEW MESSAGES
- 2** RECORD AND SEND A MESSAGE
- 3** LISTENING TO OLD MESSAGES
- 33** GROUP OLD MESSAGES
- 4** ACCESS MANAGER
- 5** PERSONAL GREETINGS
- 6** MAILBOX ADMINISTRATION
- 8** PAUSE / RESUME
- 0** PLAY MENU OPTIONS
- \*** EXIT TO AUTO ATTENDANT
- #** PERSONAL SERVICES

## 1 or 3

## LISTENING TO OLD OR NEW MESSAGES

- 1** Play / replay the message you just heard.
- 11** Play the previous message.
- 2** Save the message you just heard and listen to the next message.
- 3** Delete the message you just heard and listen to the next message.
- 4** Reply to the message.  
This will allow you to leave a message in the mailbox of the sender (if the sender has a mailbox on this system).
- 5** Return the call directly to the telephone number that left the message.  
This will work for internal and external callers, but Caller ID service is needed to use this feature on an outside call.
- 55** Deliver a fax copy.  
This will allow you to receive attached faxmail document(s). Faxmail documents can be delivered to any fax machine of your choice as long as out calling is authorized. You can also have faxmail messages automatically delivered to the fax machine of your choice.
- 6** Forward the message and saves a copy.  
The subscriber can be selected by dialing their mailbox number (nnn), using the directory service (#) or you may also add comments and leave it as a memo to yourself (##).  
The Send and Copy Service (option 6) allows a user to send copies of a message to multiple recipients easily. A different introduction message may be left for each recipient.
- 7** Rewind the message 5 seconds.
- 77** Change playback volume of the recording. **[Not available on the OS 7030, OS 7100, OS 7200-S or OS IP-UMS]**  
There are two levels of volume during playback. Dialing this code will toggle between the two levels.
- 8** Pause or resume during message playback.
- 9** Fast forward the message 5 seconds.
- 99** Change playback speed of the recording. **[Not available on OS 7030, OS 7100, OS 7200-S or OS IP-UMS]**  
There are two levels of speed during playback. Dialing this code will toggle between the two speeds.



- 0** Play options.  
Pressing this key will play all the menu options available to you from this point.
- 00** Hear the time and date, and sender's information of the message you just heard. Sender information is not available on outside calls.
- #** Move to the next message. This does not Save or Discard the current message - it is retained as new.
- ##** Scan. Plays first 7 seconds of a message then skips to next message. This is similar to the scan button on a radio. It will allow you to find a specific message quickly. To stop scanning press **[1]**.
- \*** Cancel and return to previous menu.

**11** or **33**

## GROUP NEW OR OLD MESSAGES

Messages can be grouped as either Reminders, press **[3]** or Messages from a specific sender, press **[9]**.

Additionally you can press **[#]** and hear a summary of your mailbox contents:

- a) Number of messages
- b) Number of reminders
- c) Number of urgent messages
- d) Number of messages needing a callback
- e) Number of private messages
- f) Number of fax messages

**2**

## RECORD AND SEND A MESSAGE

This option is used to send a message to another subscriber. The steps are simple:

- a) Enter the recipient's mailbox number, or if this is not known enter **[#]** to use the system directory.
- b) Record your message at the tone. After recording the message, you will hear the Send Menu with the following functions:
  - 1** Review
  - 2** Continue Recording

- 3** Discard and Re-Record
- 4** Set Message Attributes (Delivery Options)
- 5** Schedule Future Delivery
- 6** Save and Send then Send a Copy to Someone Else
- #** Save and Send the Recording

## Setting Message Attributes

If after recording a message you select **[4]** you can set up any combination of the following delivery options:

- 1** Urgent Delivery
- 2** Return Receipt Requested
- 3** Request a Call Back
- 4** Private Delivery
- 5** Reply Required
- \*** Exit

## Scheduling Future Delivery

If after recording a message you select **[5]** to schedule future delivery, you will be able to set message attributes and set this message as:

- #** Immediate Delivery
- 1** Next Few Hours
- 2** End of Current Business Day (based on your Availability Schedule)
- 3** Beginning of Next Business Day (based on your Availability Schedule)
- 4** A Coming Day of the Week
- 5** Specific Day / Time
- \*** Exit

# 4

## ACCESS MANAGER

The Access Manager allows the subscriber to set a number of options for when, where and how, and/or if the Samsung Voicemail contacts you when a caller dials your extension number. All of the options are toggled on/off based on their current status when you access them.

**Note:** ALL Access Manager options **MUST** be individually allowed by the System Administrator for each Subscriber. They are:

### 1 Follow Me

Allows the subscriber to enter an alternate location and set how long the new destination (Designated Location) will be active. This number may be an internal or external number. This is useful if you are frequently traveling or changing the number where you can be reached.

When Follow Me is activated, the transfer will be supervised and confirmed. This means that if the call is not answered or if rejected by the Subscriber at the designated location it will be recalled to the Subscriber's mailbox.

### 3 Call Blocking

When this feature is active, callers will not be transferred to your extension, they will hear your 'blocked' greeting (if recorded) and will go directly to your mailbox if they do not select any or are not offered any other options.

### 4 Call Forwarding

Unlike Follow Me where the subscriber wants to take their calls at an alternate location this feature allows the subscriber to pass control of his calls to another Subscriber. The "Forwarded To" Subscriber will now be in control of the caller and the caller will NOT return to originating Subscriber's Mailbox. If the "Forwarded To" Subscriber does not answer the caller it will now follow whatever the "Forwarded To" Subscriber has set up for their call conditions. The Caller will hear "Forwarding to" "{Subscriber Name}" before actually being forwarded.

### 5 Call Screening

If this is turned on, the caller will be asked their name and the Samsung Voicemail will play this name to you before the transfer, giving you an option to accept or reject the call.

### 6 Find Me

Find Me, when enabled, will attempt to locate the subscriber by calling a list of preprogrammed phone numbers. The stored phone numbers are entered in 'Personal Services' [#][2] (if allowed by the Administrator). The stored telephone number list can contain up to 9 preprogrammed telephone numbers. The Find Me feature only use the first five.

### 7 Night Intercept

This feature is dependent on your weekly availability schedule, which is entered in 'Personal Services' [#][3] (if allowed by the Administrator). When Night Intercept is active the Samsung Voicemail will first ring your extension then play your primary, No Answer greeting during the day (when you are available) and will NOT ring your extension but simply play your Night greeting during the night (when you are not available).

**Note:** This does NOT use the Day and Night schedules of the phone system. It is solely controlled by the Subscriber's Availability Schedule.

### 8 Pause / Resume

#### \* Exit from Access Manager

#### 0 Play All Options

#### # Play Access Coverage

This feature is useful for finding out how you current access settings are set. It will also tell you what greetings will play under each of the call conditions you have setup.

# 5

## PERSONAL GREETINGS

The options available in this menu will be determined by your System Administrator, and not all of them may be available to you. In the simplest systems, only a mailbox greeting will be available, additional greetings may be accessible in more complex systems.

Your Personal Greeting will be played every time someone dials your extension and you do not answer.

You may record up to 9 Personal Greetings, and you may assign any one of them to be active. There are several different 'Call Coverage' conditions to which you may assign any of your 9 greetings. The Call Coverage Conditions are: No-Answer, Busy, and Do Not Disturb (or Forwarded All). This will allow different greetings to play depending on the type of call forward that you have set, or the condition of your telephone.

The Call Coverage conditions that you can assign specific greetings to are selected by the following digits:

### **1 Primary/No Answer Greeting**

Used when in your office, away from your desk or during the time period you are scheduled available. If this is the only Personal Greeting you record, it will play for all call coverage conditions.

This option is available only if the Administrator has assigned you the 'Basic Greeting' feature.

Example: "Hi this is John Smith. I'm sorry I am not available to answer your call. If someone else can help you, please enter the extension number now. Or, to leave me a message, press 1."

### **2 Busy Greeting**

Played to a caller when you are already talking to someone on your extension or the telephone at your Designated Location.

This option is available only if the Administrator has assigned you the 'Busy Greeting' feature.

Example: "Hi, this is John Smith. I'm on another line right now. If someone else can help you, please enter the extension number now. Or, to leave a message, press 1."

### **3 Call Blocking Greeting**

Used while Call Blocking is enabled in your Access Manager or if your phone is forwarded ALL or DND.

This option is available only if the Administrator has assigned you the 'Call Blocking' feature.

Example: "Hi, this is John Smith. Sorry I missed your call, but I'm going to be out of the office for the next few hours. If someone else can help you, please enter the extension number now. Or, to leave me a message, press 1."

### **4 Night Greeting**

Used during the time period you are scheduled UNAVAILABLE, usually after business hours during the evening and at night.

This option is available only if the Administrator has assigned you the 'Scheduling' feature.

Example: "Hi, this is John Smith. I've left the office for the evening. If you would like to try someone else, please enter the extension number now. Or, to leave me a message, press 1."

### **5 Call Screening Greeting**

Used while Call Screening is enabled, and you REJECT a caller after listening to the caller's record name.

This option is available only if the Administrator has assigned you the 'Call Screening' feature.

Example: "Hi, this is John Smith. I'm sorry, but I am not available to speak with you at this time. If someone else can help you, please enter the extension number now. Or, to leave me a message, press 1."

### **6 Edit Personal Greetings**

You may also edit/record each one of the greetings (1-9) at any time.

Select a greeting number to edit and follow the instructions to record your greeting. When you are done recording your greeting, you will be able to listen to the greeting you recorded, save the greeting you recorded and return to the previous menu, record the greeting again, or exit without saving the greeting.

Note: If you record only the greeting assigned to the No-Answer Call Coverage Condition, then that greeting will play to callers for all Call Coverage Conditions (No-Answer, Busy, Blocked, Night, and Rejected Caller). In this case, the salutation part of the greeting should be very general.

### **7 Edit Mailbox Greeting**

Used whenever a caller reaches your mailbox or if you have not recorded any of the Call Coverage greetings. The way a caller is transferred to your mailbox greeting directly, is by another subscriber transferring the caller to your mailbox using the VT (VoiceMail Transfer) key.

This option is available only if the Administrator has assigned you the 'Mailbox Greeting Option' feature.

Example: "Hi, this is John Smith. Please leave me a message, I will call you as soon as I can."

Note: This greeting will only play if none of the 5 personal greetings has played to the caller. A common usage for this Greeting is when another Subscriber is talking with a caller and uses the VT key on their phone to transfer the caller directly to your Mailbox.

## MAILBOX ADMINISTRATION

The Mailbox Administration menu is used to turn on and off your pager notification, message alert options and other message control features.

### 1 Message Alert

When this function is activated, the Samsung Voicemail will call any outside or inside telephone number, after each message is left in your voice mailbox.

To hear your message at the remote location when the Samsung Voicemail calls you, after you pick up the telephone and answer you will be instructed that there is a message and to enter your password. Simply enter your password and you will now be logged in.

#### Setting Up Message Alert:

- From the Subscriber Services Menu press **[6]** for Mailbox Administration.
- Press **[1]** for Message Alert.
- There are 4 options available to you:
  - Press **[1]** to toggle message alert on and off.
  - Press **[2]** to set the schedule when you would like to be notified.
  - Press **[3]** to be notified on urgent messages only.
  - Press **[4]** to set the destination phone number.

### 2 Pager Notification

When this function is activated, the Samsung Voicemail will call your beeper service and notify you after each message is left in your voice mailbox.

- From the Subscriber Services Menu press **[6]** for Mailbox Administration.
- Press **[2]** for pager notification.
- There are 4 options available to you:
  - Press **[1]** to toggle pager notification on and off.
  - Press **[2]** to set the schedule when you would like to be paged.
  - Press **[3]** to be notified on urgent messages only.
  - Press **[4]** to set the pager phone number.

### 3 Undelete

When this function is activated, the Samsung Voicemail will allow you to undelete any messages that you have recently deleted (up to the programmed Daily Maintenance Time, which is set to 3 a.m. by Default the following morning).

- From the Subscriber Services Menu press **[6]** for Mailbox Administration.
- Press **[3]** for Deleted Messages.

Deleted voice mail messages are temporarily stored in memory until 3 a.m. the following day. Select this option to recover ("undelete") previously deleted messages, during this period of time.

### 4 Undelivered Retrieval

When this function is activated, the Samsung Voicemail will allow you to recall any messages you have sent that have NOT yet been picked up by the recipient.

- From the Subscriber Services Menu press **[6]** for Mailbox Administration.
- Press **[4]** for Undelivered Messages.

This useful feature will allow you to cancel any messages that have NOT yet been picked up by the recipient.

### 5 Auto Play New Messages

If this option is enabled, after you enter your password correctly any new messages will immediately begin to play. To enable (or if already enabled toggle and disable) this feature:

- From the Subscriber Services Menu press **[6]** for Mailbox Administration.
- Press **[5]** to Set Auto Play of New Messages.

### 6 Auto Play Message Information

If this option is enabled, the date, time and sender's name will be played automatically before each message. If this is disabled, the information must be requested manually by pressing '00'. To enable (or if already enabled toggle and disable) this feature:

- From the Subscriber Services Menu press **[6]** for Mailbox Administration.
- Press **[6]** to Set Auto Play of Message Information.

## MESSAGE BROADCAST

This option will only be available if it has been allowed by the System Administrator.

### Broadcast to All Mailboxes

If you have been designated as a Subscriber Administrator, you may send a message to ALL mailboxes in the system.

- From the Subscriber Services Menu press [6] for Mailbox Administration.
- Press [9] for Broadcast Messages.

This option will only be available if your mailbox has been assigned Subscriber Administration privileges.

## PERSONAL SERVICES

The Personal Administration Menu is used to set your password and record your name. Many of these features must be allowed by the System Administrator.

### 1 Workload Management

Allows you to access to all reminders, both Active and Pending. If authorized you can group your reminders as Commitments, Follow-Ups or Tasks for better organization. The system will flag each reminder as Active or Pending (pending means scheduled for future delivery).

### 2 Stored Numbers

Allows you to enter up to 9 stored phone numbers. The first five of these are used in the 'Find Me' feature, but any of them (1-9) can be easily dialed using only one digit followed by the pound key, to be used by many other features from within your subscriber space. (ie: "Follow Me," "Message Alert," "Pager Alert," and "Direct Call").

### 3 Schedule Availability

Allows you to enter a weekly availability schedule for use with Night Personal Greeting and the Auto Night Intercept feature. Follow the spoken directions

to enter the days of the week and times you are generally available to talk to your callers. All other times you will be considered unavailable.

### 5 Place a Direct Call

Allows you to place a direct call out of the Samsung Voicemail from anywhere. You may either dial the number or dial a single digit 1-5 that corresponds to a stored number ([See Personal Services, 2 - Stored Numbers](#)). This feature must be authorized by the System Administrator and can be limited or opened to internal, local, and long distance calls.

### 7 Personal Administration

This area is used during the initial set up of your Subscriber Settings ([see next section](#)).

## PERSONAL ADMINISTRATION SETTINGS

This menu allows you to make changes to basic setup settings, that are rarely changed. Use these when you initially set up your personal Subscriber settings. You probably will not need to change them after that.

### 1 Setting your Password

- From the Subscriber Services Menu press [#][7][1].
- The current password will be played and you will have the chance to change it.

### 2 Recording your Name

Use this option to record your name. Your recorded name is played in several different situations. It is important to record your name for proper operation of the Samsung Voicemail system.

- From the Subscriber Services Menu press [#][7][2].
- The current name will be played and you will have the chance to change it.

Note: It is possible that if you do not record your name and/or enter your Directory Name (described below), you will not be included in the Dial by Name Directory.

### 3 Entering your Directory Name

Use this option to enter your Directory Name. Your Directory Name is used by callers to find you if they do not know your extension number.

- From the Subscriber Services Menu press [#][7][3].

- The current Directory Name will be played as a string of digits that are equal to your name spelled out on your telephone keypad. Follow the instructions to enter a new name. You will be prompted to enter your last name and then your first name.

This must be done in order for the directory feature to work correctly.

Note: It is possible that if you do not record your name (described above) and/or enter your Directory Name, you will not be included in the Dial by Name Directory.

#### 4 Extended Prompting

Use this option to drastically reduce the number of prompts played in the subscriber interface (mailbox prompts). Change this setting only if you are very familiar with the user operation of the SVMi E-Series.

Note: Remember if you know what digits to press, you can enter them at any time you do not have to wait to be prompted. This feature can be toggled on/off at anytime. Also if it is off you will be prompted within each subscriber menu to press zero for more options. This enables you to still be able to find out what to do if you were to get lost and extended prompting was disabled.

## KEYSET USER FEATURES

The following options are available if you have a display keyset. They require setup by the System Administrator.

### Message Waiting Lights

When new messages are left in your mailbox, the voice mail message light on your keyset will flash. Press this flashing key [**VMMSG**] and follow the prompts to retrieve messages. This key may be pressed at any time to log into your Subscriber Main Menu.

### Answer Machine Emulation

If you have an Answer Machine Emulation key programmed on your keyset, you can use it to monitor calls going to your voice mail, and optionally answer them. The operation of this feature is similar to screening a call on a home answering machine.

Your keyset must be set to forward on no answer to voice mail. After ringing your station the caller will be connected to your voice mail and hear your personal greeting before leaving a message. During this time you will be monitoring the connection between the caller and your voice mail box. At this time you will only be monitoring the call, you can not talk to the other party until you answer. You may pick up the call at any time or ignore it.

To activate this feature press the **AME** button. The associated indicator will be lit steady. Press again to turn off. If this key is pressed while a station is ringing (during forward no answer), the feature will be turned on for the current call only.

While the caller is leaving a message or ringing you may:

- Press [**#**] to immediately put the caller in your voice mailbox and monitor it.
- Press [**\***] to immediately disconnect your station. The caller continues to leave a message normally.
- Pick up the handset and monitor privately.
- Press **ANS / RLS** to answer the call (using the handset or speaker).

### AME Password

If your keyset has **AME Password** (MMC 110) set to **Yes**, you must enter your station password to listen to messages being left. This will prevent unauthorized people from listening to messages being left for you.

If the password option is turned on, while a message is being left, press the flashing **AME** indicator and enter your station password (not your SVMi E-Series password). You will then hear the message being left.

### Call Record

If you have a call record button assigned to your phone, you may press it at any time, to record the conversation in progress. If you have a display keyset, you will also have the soft key options to pause and time the message.

## SHORTCUTS

### Calling

Calling a station that is busy or does not answer you can press [#] to immediately send the call to the called parties mailbox.

### Call Divert to Voicemail

While receiving an incoming (ringing) call, dial [\*] to immediately send the caller to your personal voicemail box. This will override the call forward no answer setting.

### Direct Messaging

[#] + DSS To make it easy to leave messages for others in your office without having to dial their extension number first, keyset users may simply dial [#] plus a mailbox (extension) number and leave a message directly. If you dial a busy extension press [#] to connect directly with the mailbox.

### Self Memo (Reminder)

Pressing [##] will leave a message in your own mailbox. This is useful to remind yourself of things to do now or in the future. Messages can be sent with future delivery so you can have the system call you when items become due.

## INTERACTIVE DISPLAYS

Display keyset users have the added advantage of using the soft keys and displays to play, save, delete, reply, call, forward, rewind, pause, fast forward, change the volume, get message information, or help.

### Viewing Mailbox Contents

If you have new messages, in addition to the Terminal Status Indicator (TSI) you will be able to use the keyset displays and soft keys to communicate with the SVMi E-Series.

## E-MAIL GATEWAY (EMG)

The E-Mail Gateway feature integrates your voice mail box with your email client. No matter what email client software you are using or where you use it, you can send voice mail messages and fax mail messages to your E-Mail inbox.

There are two parts to the E-Mail Gateway; E-Message Delivery and E-Message Notification.

1. **E-MESSAGE DELIVERY:** Voice mail messages (.wav) and/or fax mail messages (.tiff) are "delivered" to your Inbox with the appropriate attached file.
2. **E-MESSAGE NOTIFICATION:** You will receive an e-mail, with NO attachments, notifying you that you have a voice and/or fax mail message in your Voice Mail Box.
  - As a subscriber you can use either E-Message Delivery and/or E-Message Notification.
  - As a subscriber you can have multiple e-mail addresses. (a maximum of 5 valid email addresses).
  - E-Message Notification can be set to one e-mail address while E-Message Delivery is set to different e-mail address.

## Functionality

- With either type of EMG, when Caller ID (CID) is provided, the callers telephone number will appear in the subject field of the email along with the date and time stamp of when the voice message was originally recorded in your Voice Mail Box.
- If the caller is also a subscriber on the system and the E-Mail Gateway is set up with a valid "Reply To" address, the Subscriber's name will also appear in the "From" field. Otherwise, the "From" field will display the name of the Samsung voice mail system (SVMi-8E, SVMi-16E, or SVMi-20E) sending the message.
- Client will use their PC's Multi-Media kit (equipped with either speakers and/or a headset) to listen to messages delivered to their e-mail Inbox.

**IMPORTANT NOTE:** If the PC/Laptop/PDA/Smart Phone/etc... is not equipped with hardware and software capable of playing a '.WAV' file then the E-Mail Gateway will not work for them until they add some method to listen to '.WAV' files delivered to their Inbox.

The same applies to Fax Mail messages, if the device the subscriber is using does not support the viewing of '.TIFF' files, then the E-Mail Gateway for Fax Mail will not work for them until they add some method to view .tiff files delivered to their inbox.

- No Synchronization of messages is performed between the Voice Mail Box and the E-mail Inbox.
  - Messages listened to, forwarded, deleted, and/or saved within an e-mail inbox will NOT effect the status of that same new message in the Voice Mail or the MWI (Message Waiting Indicator) associated with that message on the phone.
  - Also messages listened to in the Voice Mail, from a phone, will not change the Unread/Read status of the same message in an e-mail inbox.

- However, the Voice Mail Administrator can adjust parameters per subscriber or group of subscribers that decide how, when, or if to delete the original voice message after it is sent to the E-Mail Server.

- When full synchronization of messages between Voicemail Box and E-mail Inbox is required, ask your Samsung representative about the OfficeServ IP-UMS. This is an Internet Protocol based fully synchronized Unified Messaging System.

## Benefits

- Store and Archive Voice and Fax Mail Messages in visible folders.
- Voice and Fax Mail Messages can now easily be dragged and dropped into folders the same way e-mail messages are organized and saved.
- Voice and Fax Mail Messages are now essentially the same as any other e-mail message.
- Backups and Message Archives can be made when they are made for all other types of e-mail messages.
- Add text notes and comments to use for reference later.
- Some (if not all) e-mail clients will allow you to edit the body of the e-mail to add comments.
- Some will allow you to edit the subject field to help you find a particular message quickly in a large archive of messages.
- Call Back Numbers and Date & Time Stamp are easily displayed in the Subject field.
- Easily forward Voice messages received, to others even if they are not a Voice Mail Subscriber on your system.
- No EMG System or Client Software to load on your Local PC or Network Servers.

Therefore compatible with most:

- E-Mail providers and E-Mail Clients
- PCs, Laptops, PDA, and/or Smartphones

**NOTE:** If you are not sure you have this functionality on your system and you would like to use it, please contact your on Site system administrator to see if it is available.

## PERSONAL SPEED DIAL NUMBERS

CODE	NAME	TELEPHONE NUMBER
00	_____	_____
01	_____	_____
02	_____	_____
03	_____	_____
04	_____	_____
05	_____	_____
06	_____	_____
07	_____	_____
08	_____	_____
09	_____	_____
10	_____	_____
11	_____	_____
12	_____	_____
13	_____	_____
14	_____	_____
15	_____	_____
16	_____	_____
17	_____	_____
18	_____	_____
19	_____	_____
20	_____	_____
21	_____	_____
22	_____	_____
23	_____	_____
24	_____	_____



# PERSONAL SPEED DIAL NUMBERS

CODE	NAME	TELEPHONE NUMBER
25	_____	_____
26	_____	_____
27	_____	_____
28	_____	_____
29	_____	_____
30	_____	_____
31	_____	_____
32	_____	_____
33	_____	_____
34	_____	_____
35	_____	_____
36	_____	_____
37	_____	_____
38	_____	_____
39	_____	_____
40	_____	_____
41	_____	_____
42	_____	_____
43	_____	_____
44	_____	_____
45	_____	_____
46	_____	_____
47	_____	_____
48	_____	_____
49	_____	_____

## FEATURES AND SPECIFICATIONS

### LINE GROUPS

9 Local/LCR  
 800 \_\_\_\_\_  
 801 \_\_\_\_\_  
 802 \_\_\_\_\_

### STATION GROUPS

501 \_\_\_\_\_  
 502 \_\_\_\_\_  
 503 \_\_\_\_\_  
 504 \_\_\_\_\_

### PAGING ZONES - DIAL 55 PLUS

0 \_\_\_\_\_  
 1 \_\_\_\_\_  
 2 \_\_\_\_\_  
 3 \_\_\_\_\_  
 4 \_\_\_\_\_  
 5 \_\_\_\_\_  
 6 \_\_\_\_\_  
 7 \_\_\_\_\_  
 8 \_\_\_\_\_  
 9 All External Zones  
 \*All External Zones and Internal Zone 0

### PROGRAMMED MESSAGES

01 In A Meeting  
 02 Out On a Call  
 03 Out To Lunch  
 04 Leave A Message  
 05 Page Me  
 06 Out Of Town  
 07 In Tomorrow  
 08 Return Afternoon  
 09 On Vacation  
 10 Gone Home  
 11 \_\_\_\_\_  
 12 \_\_\_\_\_  
 13 \_\_\_\_\_  
 14 \_\_\_\_\_  
 15 \_\_\_\_\_  
 16 \_\_\_\_\_  
 17 \_\_\_\_\_  
 18 \_\_\_\_\_  
 19 \_\_\_\_\_  
 20 \_\_\_\_\_

### FEATURE ACCESS CODES

10 + xxx Pick Up A Parked Call  
 12 + xxx Pick Up A Held Call  
 13 Door Lock Release  
 16 + xxx Speed Dialing  
 17 Save And Redial Number  
 18 New Call (Recall)  
 19 Last Number Redial  
 400 Cancel Do Not Disturb  
 401 Set Do Not Disturb  
 42 + xxx Cancel Message You Left  
 43 Return Message  
 44 Callback  
 45 Busy Station Camp-On  
 46 Conference  
 47 Account Code  
 48 + xx Cancel Programmed MSG  
 49 Send Flash To C.O. or PBX  
 56 Meet Me Answer  
 600 Cancel All Call Forward  
 601 + xxx Set Forward All Calls  
 602 + xxx Set Forward Busy  
 603 + xxx Set Forward No Answer  
 604 + xxx Set Fwd Busy/No Answer  
 605 + xxx Set Forward on DND  
 606 + xxx Set Forward Follow Me  
 65 + xxx Pick Up Ringing Extension  
 66 + xx Pick Up Group  
 67 Universal Answer  
 \* Authorization Code



[www.samsung.com/bcs](http://www.samsung.com/bcs)

# OfficeServ™ SMT-i5210



USER GUIDE



## OfficeServ™ SMT-i5210 Keypad User Guide

*For OfficeServ™ 7000 Series Systems*

# TABLE OF CONTENTS

<b><u>ABOUT THIS BOOK</u></b> .....	1
<b><u>SECTION 1. CAUTION AND PREPARATION</u></b> .....	2
<b><u>CAUTION</u></b> .....	3
<b><u>PREPARATION</u></b> .....	4
Check the Contents of the Box .....	4
Phone Installation .....	4-5
Optional Equipment.....	5-6
<b><u>SECTION 2. PHONE FUNCTIONS</u></b> .....	7
<b><u>SMT-i5210 LAYOUT</u></b> .....	8
Names and Functions .....	8-9
<b><u>KEY FUNCTIONS</u></b> .....	10
Telephone Status Indicator .....	10
Screen Structure .....	10
Text Input Method .....	11
Description of Icons .....	12
Navigating the Menus.....	13
Navigation Button and Select Switch for FWD/DND/ABSENT MSG.....	13
<b><u>SMT-i5210 SETUP</u></b> .....	14
Initializing the SMT-i5210 .....	14
Setup Mode .....	14
Easy Install Wizard .....	15
Selecting the Static IP Option .....	15
Setting Up Hot Desking (Idle Login) .....	15
Configuration Menu Structure.....	16
<b><u>SECTION 3. FREQUENTLY USED</u></b> .....	
<b><u>FEATURE OPERATION</u></b> .....	17
<b><u>EXTENSION LOG IN &amp; OUT</u></b> .....	18
<b><u>PLACING CALLS</u></b> .....	18
<b><u>ANSWERING CALLS</u></b> .....	19
<b><u>PLACING A CALL ON HOLD</u></b> .....	20
<b><u>TRANSFERRING CALLS</u></b> .....	20

Copyright 2010 Samsung Telecommunications America.

All rights reserved. No part of this manual may be reproduced in any form or by any means—graphic, electronic or mechanical, including recording, taping, photocopying or information retrieval systems—without express written permission of the publisher of this material.

Samsung Telecommunications America reserves the right without prior notice to revise information in this guide for any reason. Samsung Telecommunications America also reserves the right without prior notice to make changes in design or components of equipment as engineering and manufacturing may warrant. Samsung Telecommunications America disclaims all liabilities for damages arising from the erroneous interpretation or use of information presented in this guide.

<b>TRANSFERRING WITH CAMP-ON</b> .....	21
<b>CALL WAITING</b> .....	21
<b>CONFERENCE CALLS</b> .....	21
<b>FORWARDING CALLS</b> .....	22
<b>OTHER FEATURES AND FUNCTIONS</b> .....	22-25
<b>SECTION 4. PHONE FEATURES</b> .....	26
<b>BASIC MENUS</b> .....	27
Soft Button Structure .....	27
Menu Soft Button .....	27-36
Func. Soft Button .....	36
AOM Soft Button .....	37
<b>SECTION 5. OFFICESERV 7000 SYSTEM FEATURES</b> .....	38
<b>OUTSIDE CALLS</b> .....	39
Making Calls from AOM .....	39
Universal Answer .....	39
Recall Dial Tone .....	39
Sending a Flash .....	39
Busy Line Queuing with Callback .....	39
Busy Station Callback .....	40
Canceling Callback .....	40
Busy Station Camp-On .....	40
<b>INTERCOM CALLS</b> .....	42
Voice Announce Mode .....	42
Auto Answer Mode .....	42
Calling your System Operator .....	42
<b>CALL PROCESSING</b> .....	43
System Hold .....	43
Exclusive Hold .....	43
Remote Hold .....	43
Hold Recall .....	44
Consultation Hold .....	44
Retrieving Calls Held at Another Station .....	44
Call Transfer .....	45
Transfer with Camp-On .....	45
Transfer to Voice Mail .....	46
Call Waiting .....	46
Call Forward Options .....	46
Station Call Pickup .....	47

Group Call Pickup .....	48
My Group Pickup .....	48
Privacy Release .....	48
<b>DIALING FEATURES</b> .....	49
Speed Dialing .....	49
Programming Personal Speed Dial Numbers .....	49
Directory Dialing .....	50
Last Number Redial .....	51
Save Number with Redial .....	51
Automatic Redial/Retry .....	51
Pulse to Tone Changeover .....	51
<b>PAGING AND MESSAGING</b> .....	52
Making and Internal Page .....	52
Making an External Page .....	52
All Page .....	52
Meet Me Page .....	53
Call Park and Page .....	53
Messages—Set and Cancel .....	54-55
Returning Messages .....	55
Programmed Messages .....	55
<b>CONVENIENCE FEATURES</b> .....	56
Logging In and Out .....	56
Do Not Disturb .....	56
One Time DND .....	56
Mute .....	57
Background Music .....	57
Established Call Pick-Up .....	57
Door Phone Calls .....	57-58
Executive/Secretary Hotline .....	58
Group Listening .....	59
Account Codes .....	59
Locking Your Keypad .....	60
Manual Signalling .....	60
Off-Hook Voice Announce .....	61
OHVA Block .....	61
OHVA Reject .....	61
In Group/Out of Group .....	62
<b>CUSTOMIZING YOUR KEYSSET</b> .....	63
AME Password .....	63
Auto Camp-On .....	63
Select Ring Tone .....	63
Change Your Passcode .....	63

Set Answer Mode (Intercom) .....	64
Set Answer Mode (CO) .....	64
Automatic Hold .....	64
Headset Operation.....	64
Hot Keypad .....	65
Key Confirmation Tone .....	65
Rejoining a Page .....	65
Ring Preference .....	65
Display Speed Dial Name .....	66
Caller ID Review All .....	66
Secure OHVA .....	66
Configure Mobile Extensions (MOBEX) .....	66-67

Mailbox Administration .....	87
Message Broadcast .....	89
Personal Services .....	89
Personal Administration Settings .....	90
Keypad User Features .....	91
Shortcuts .....	93
Interactive Displays .....	93
E-Mail Gateway (EMG) .....	93-95

**PERSONAL SPEED DIAL NUMBERS.....96-97**

**DISPLAY FEATURES .....**68

Directory Information .....	68
Display Number Dialed .....	68
Call Duration Timer .....	68
Auto Timer .....	68
Timer Function .....	69
Viewing Station Message Indications.....	69
Personal Speed Dial Names .....	69
Station Names .....	69
Managing Programmable Key Assignments .....	70
Backspace with LCR.....	70

**CALLER ID.....**71

Selecting Your Caller ID Display .....	71
Viewing the Next Caller ID Call .....	72
Inquire Caller ID Park/Hold Info .....	72

**FEATURE ACCESS CODES .....**73

**SECTION 6. APPLICATIONS .....**74

**SAMSUNG VOICEMAIL .....**75

SVMi E-Series Subscriber Services Menu Diagram .....	76-77
Accessing Your Mailbox .....	78
Getting Started .....	79
Listen to your Messages .....	79
Subscriber Services Menu .....	79
Listening to Old or New Messages .....	80
Group New or Old Messages .....	81
Record and Send a Message .....	81
Access Manager .....	83
Personal Greetings.....	84

## ABOUT THIS BOOK

The new Samsung Multimedia Telephone SMT-i5210 keyset is part of the OfficeServ 7000 Series.

The SMT-i5210 keyset represents a new concept of Internet phone, in that it uses an IP address to Send/Receive voice and data. For voice communications, the SMT-i5210 uses the data network line already in place in most offices and increasing number of homes.

This guide contains 6 sections: Section 1. Caution and Preparation, Section 2. Phone Functions, Section 3. Frequently Used Feature Operation, Section 4. Phone Settings, Section 5. OfficeServ 7000 System Features and Section 6. Applications. Please take the time to study this guide and to become familiar with the operation of your keyset. Keep this guide handy, as you may need to look up instructions for infrequently used features.

This book is written based on factory default settings, for the feature access codes. Sometimes, due to programming requirements, these codes may be changed. If you find that a feature code does not work as described in this book, please contact your installation and service company to determine the correct code.

## CAUTION

# SECTION 1. CAUTION AND PREPARATION

- Read the installation instructions before connecting the system to its power source.
- If there is dirt or moisture on the pin contact surface of a power plug, pull out the plug and wipe it away with a cloth. If dirt or moisture remains on the product even after wiping, contact the service center.
- For the power connection port of the phone, use the supplied power adapter. (The power adapter is supplied separately.) Use of a power adapter that does not meet the specifications may cause the product to become damaged, to overheat, or to explode.
- Do not place the phone in a location with a lot of dust, in a location that is subject to severe changes in temperature, or near a heating device (cigarette heat, heater, etc.)
- Do not use or store flammable spray or materials near the phone.
- Do not place vases, flowerpots, cups, or a container of cosmetics or drugs near the phone.
- Installation of equipment must not route interconnecting cables or external power supply sources outdoors.
- The LAN cable to the network should be connected to the LAN port of a phone, NOT to the PC connection port.
- Use a soft and dry cloth when cleaning the phone. Do not spray water directly onto the product; and do not use chemicals such as wax, benzene, alcohol, thinner, mosquito killer, perfume spray, lubricant, detergent, etc.

# PREPARATION

## CHECK THE CONTENTS OF THE BOX

Check if the product package box includes all the components as follows:

- Phone body including a base
- Handset
- Handset cord
- Patch cable

**NOTE:** Power transformer sold separately. If any of these items are missing or damaged, please contact your dealer.

## PHONE INSTALLATION

### Connecting the Phone Body

- 1 Remove the base of the phone by pressing the **[Push]** mark on the top of the base.

Note: The base can be used to adjust the phone angle in the high or low position.

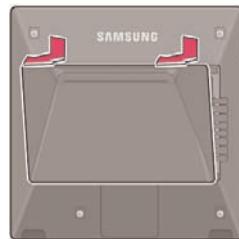

- 2 Connect a handset to the handset port of the phone.

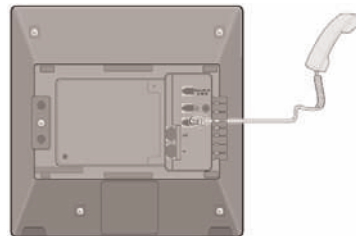

- 3 OPTIONAL: Connect the cable through the middle hole of the base to the PC, as shown in the figure. When connecting to PC, connect one end of the cable to the PC port of the phone, and the other end of the cable to the LAN port of the PC.

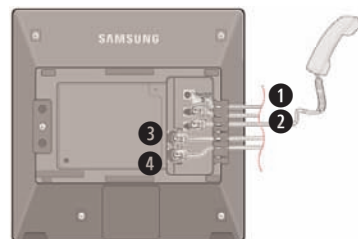

① AC Power ② LAN to Phone System ③ Phone to PC ④ Headset

Connect the LAN cable (connected through the middle hole of the base to a network) to the LAN port of the phone, as shown in the figure.

When power is supplied from the LAN port (PoE), the phone is booted upon LAN connection.

If PoE is not supported, connect the power adapter to the **power port** of the phone by running the cable through the middle hole of the base as shown in the figure below. If the connected power adapter is plugged into an outlet, the phone is booted. (The power adapter is supplied separately.)

- 4 Fix the base to the phone body by fitting the bottom groove and then securing the top side.

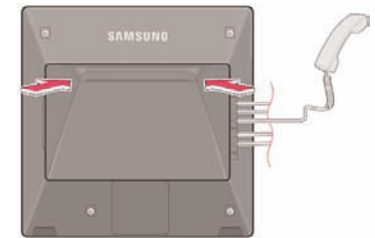

- 5 Secure the cable along the cable guideline as shown in the figure. For the cable of power adaptor, give some slack before securing the cable to the guideline to prevent easy disconnect.

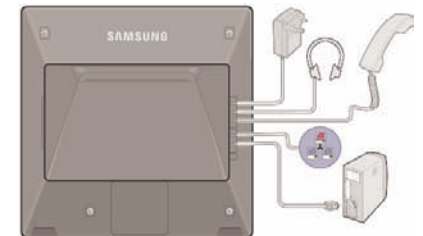

## OPTIONAL EQUIPMENT

### SMT-i5264 [ADD-ON MODULE]

The **SMT-i5264** IP AOM can be registered and programmed to function with any ITP 5100 keysets, SMT-i Series, and TDM phones. This add-on module was cosmetically designed to match the SMT-i5000 Series phones. In some applications multiple IP AOMs can be supported per IP phone. *For installation instructions, see your System Administrator.*





### **SMT-A52GE [GIGABIT ADAPTER]**

The **SMT-A52GE** Gigabit Adapter processes the Gigabit data for a Gigabit LAN connection on the PC connected to the SMT-i5200 Series IP phones. The SMT-A52GE can be installed to function with any of the SMT-i5200 Series IP phones. *For installation instructions, see your System Administrator.*



### **WALL MOUNT BRACKET**

An optional bracket is available for wall mounting the SMT-i5200 Series phones to the wall. *For installation instructions, see your System Administrator.*

### **SMT-A53PW [POWER ADAPTER]**

The power adapter is sold separately.

### **CAUTION**

The input power of the SMT-i5210 needs 5.0vDC and 3000mA. The SMT-i5210 phone needs to be powered by using Samsung's SMT-A53PW power adapter. Failure to use the appropriate power supply will cause permanent damage to the phone and will void Samsung's warranty.

## **SECTION 2. PHONE FUNCTIONS**

# SMT-i5210 LAYOUT

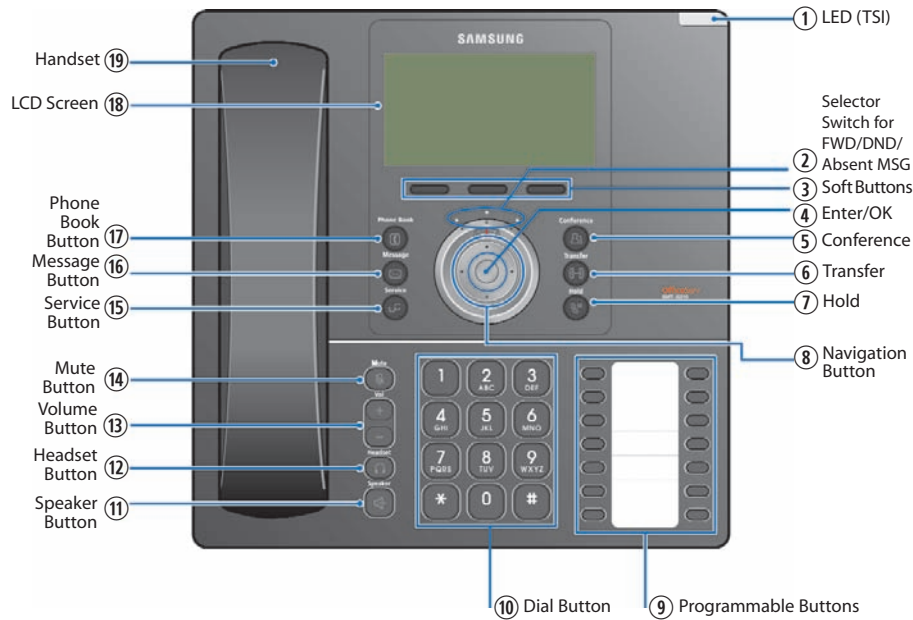

**NOTE:** The words “key” and “button” are interchangeable.

## NAMES AND FUNCTIONS

Button	Function
① LED (TSI)	The blinking pattern differs depending on the phone status (Telephone Status Indicator).
② Selector Switch for FWD/DND	Used to select or deselect the <b>Call Forwarding/DND/Absent Message</b> setting by using the Selector Switch control.
③ Soft Button	Used to select the desired function from the soft menus displayed at the bottom of the LCD screen.
④ Enter/OK	Used to make selection or to save an entry.
⑤ Conference Button	Used for conference calls.
⑥ Transfer Button	Used to enable the call transfer function.
⑦ Hold Button	Used to place a call on hold.
⑧ Navigation Button	Used to move the display cursor up and down, left and right on certain menus.

Button	Function
⑨ Programmable Buttons	14 Buttons used to set up function buttons through interworking with a system.
⑩ Dial Button	Used to dial the phone number.
⑪ Speaker Button	Used to enable/disable the use of a speaker phone.
⑫ Headset Button	Used to activate and deactivate the headset jack.
⑬ Volume Button	Used to control the volume settings.
⑭ Mute Button	Used to silence the transmit voice to the remote party.
⑮ Service Button	For use with the Unified Communicator Server and to set Scheduler (optional).
⑯ Message Button	Used to access all the messaging options: Voicemail Messages, Station Messages, SMS, and E-Mail Messages.
⑰ Phone Book Button	Used to search for a phone number saved in the phone, or to register a new number. Pressing this button shows the main screen of the phone book. Used to move downward on various list screens.
⑱ LCD Screen	A display showing the phone's status (busy, ringing, receiving an internal message, etc.)
⑲ Handset	Used for two-way voice conversation.

# KEY FUNCTIONS

**NETWORK:** The SMT-i5210 uses VoIP communication through an already-installed data network.

**LCD SCREEN:** Various functions are displayed on the LCD screen, so you can use them conveniently by using the **Navigation** button on the phone.

**SHORT MESSAGE SERVICE (SMS):** You can exchange text messages using this function. This function is available on internal IP stations.

## TELEPHONE STATUS INDICATOR

The indicators are turned on or off depending on the status of relevant functions.

Screen	Status	LED Indicator
	When station is busy	Red colored indicator is constant.
	When station is receiving an incoming call	Red indicator (slow flash).
	When there is a message	Red indicator (slow flash).
	During "Do Not Disturb"	Red indicator (fast flash).
	Incoming Trunk Call	Green colored indicator flashes.
	Hold Recalls	Amber colored indicator flashes.

## SCREEN STRUCTURE

The screen consists of three areas.

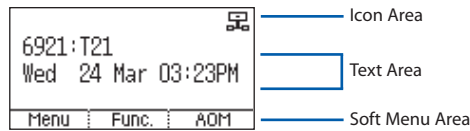

Area	Description
Icon Area	Displays various icons.
Text Area	Displays date, time, extension number, name, message, phone number, etc.
Soft Menu Area	Displays the functions allocated to the 3 soft buttons. Service menus are provided depending on the state of the phone. A user can use the service or feature menus by pressing the <b>Menu</b> or <b>Func.</b> soft button, or the <b>AOM</b> for more soft keys (99).

## TEXT INPUT METHOD

Using the dial and direction buttons on the phone, you can enter and modify the English characters, numeric and special characters.

Whenever you press the dial button [\*] on a text input screen, the input mode is changed in sequence.

### Text Input Example

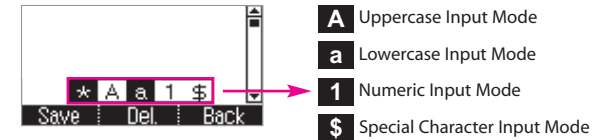

- Use the dial buttons to type English text and numbers; and use the **Navigation Button** to move the cursor left and right and **OK** buttons to complete input. When removing the typed characters, select the **Del** soft button.

**Alpha Characters Input:** Select this mode (uppercase/lowercase) by pressing the [\*] button on keypad, and type text by repeated pressing the dial buttons, characters will auto advance after a time limit.

**Number Input:** Select this mode by pressing the [\*] button on keypad, move the cursor highlighted to 1, then use the keypad to enter digits.

**Special Character Input:** Select this mode by pressing the [\*] button on keypad; select a desired character by using the **Navigation Button**; and press the **OK** button to enter it.

### Keypad Character Entry

Count	1	2	3	4
<b>Dial *</b>	A (Uppercase)	a (Lowercase)	1 (Numbers)	\$ (Special Characters)
<b>Dial #</b>	Not Used			
<b>Dial 0</b>	Not Used			
<b>Dial 1</b>	Not Used			
<b>Dial 2</b>	A	B	C	
<b>Dial 3</b>	D	E	F	
<b>Dial 4</b>	G	H	I	
<b>Dial 5</b>	J	K	L	
<b>Dial 6</b>	M	N	O	
<b>Dial 7</b>	P	Q	R	S
<b>Dial 8</b>	T	U	V	
<b>Dial 9</b>	W	X	Y	Z

## DESCRIPTION OF ICONS

The following icons are displayed on the screen.

Icon	Description
	Shows that 'Call Forward' is enabled.
	Shows that 'Do Not Disturb' is enabled.
	Shows that 'Mute' function is enabled. When the call ends to become a standby status or this function is disabled, this icon disappears.
	Shows that the call is <b>hold</b> state. When call is reconnect or disconnected, this icon disappears.
	Appears when there are unread short <b>messages</b> in the message inbox. Once they are read, it disappears.
	Shows that a LAN cable is <b>connected</b> to the <b>PC port</b> .
	Shows that a <b>LAN cable</b> is connected to the LAN port but that the system is <b>not connected</b> .
	Shows that a <b>LAN cable</b> is <b>connected</b> to the LAN port and that the system is connected normally.
	<b>Outgoing Call</b> icon.
	<b>Incoming</b> Call icon.
	<b>Missed</b> Call icon.
	Appears when the <b>Speaker</b> button is active.
	Appears when the <b>Headset</b> button is active.
	Shows when there is a <b>Cell phone</b> number for the entry in the Phone Book.
	Shows when there is a <b>Home phone</b> number for the entry in the Phone Book.
	Shows when there is a <b>Office phone</b> number for the entry in the Phone Book.
	Shows when there is an internal <b>Extension</b> number for the entry in the Phone Book.

## NAVIGATING THE MENUS

When programming within various menu options, information can be entered via the dial pad keys using [0]-[9] and [\*] dial keys. The button used for editing and their features are summarized below.

BUTTONS	FEATURES
<b>Volume + and -</b>	To move the cursor left and right, up and down.
<b>Hold</b>	To clear/delete an entire field such as station name.
<b>Transfer</b>	To write the changes and exit programming.
<b>Speaker</b>	To write the changes and exit programming.

## NAVIGATION BUTTON and SELECTOR SWITCH FOR FWD/DND/ABSENT MSG

The SMT-i5210 phone has a navigation button and a Selector Switch for FWD/DND/ABSENT MESSAGE to allow users to use its functions easily.

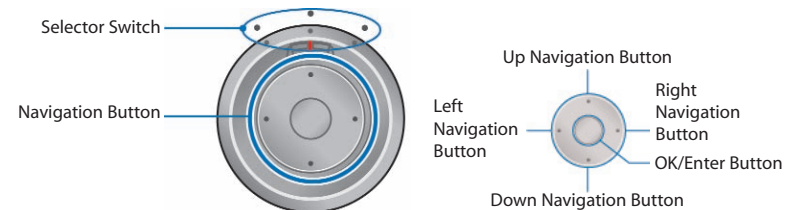

The Selector Switch can be used to manually set and cancel station Call Forwarding and Do Not Disturb. **NOTE:** Do not use the access codes or the function menu to cancel FWD/DND/ABSENT MESSAGE when the selector switch is set in the left or right position because the switch takes precedence over the access codes/function menu.

BUTTON	FUNCTION	
<b>Selector Switch</b>	Left	Users can set the phone to the call forward state.
	Center	The default standby status. (Normal Mode)
	Right	This is set to "Do Not Disturb" and absent message status.
<b>Navigation</b>	Direction Key	Users can edit the contents on the screen or move between menu items.
	OK/Enter	Users can select or save the item where a cursor is placed in a menu mode. Users can check the caller information received from a station line during receiving.

# SMT-i5210 SETUP

## INITIALIZING THE SMT-i5210

Initially the SMT-i5210 IP keyset will need to be setup to operate within the users network. The Setup Menu is also used to make changes to the keyset, in the event that the system information should change. The option chosen will be highlighted.

The station numbers will be automatically set by the OfficeServ 7000 Series systems once the necessary information has been entered into the IP keyset. Enter ID and password of the server, as described below to register the phone.

See your system administrator for specific Network and Server addresses. The addresses necessary to set up the SMT-i5210 are:

- IP Address of Station
- Network Gateway Address
- IP Address of System's main processor
- User ID
- Password

## SETUP MODE

To get to the **Setup Mode** unplug the power cord from the SMT-i5210. Press and hold the \* button while you plug power back into the phone. Release the \* button when you see Samsung in the display. If you have a PoE (Power over Ethernet) connection, the same procedure can be done by unplugging and plugging the Ethernet cable into the phone while pressing and holding the \* button.

When the phone reboot is complete, the **Language Menu** will display. Press the **Yes** soft button to advance to the **Configuration Menu**.

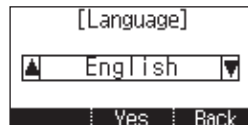

Once the **Configuration Menu** is displayed, you can move to each menu in the Setup by using the navigation button and [1]-[8] dial buttons of the SMT-i5210 IP phone. [To learn how to navigate the menus refer to the previous section.](#)

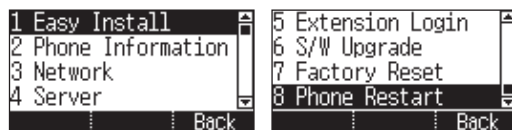

## EASY INSTALL WIZARD

By selecting this option, the System Easy Wizard can guide you through setting up your network parameters. If you want to set up these parameters individually, follow the instructions below.

- From the idle phone press **Menu**, scroll to **Phone**, and press **OK** button. Scroll to **Phone Information** and press **OK** button. From the keypad, press [**\*153#**]. Scroll to **Easy Install** and press **OK** button.

## SELECTING THE STATIC IP OPTION

- When the Static IP option is selected, enter the System Type OSSP (KP), and press **OK**.
- Enter the **Static IP Address** for the phone (eg. 192.168.9.193) then press the **OK** button.
- Enter the **Subnet Mask** (eg. 255.255.255.0); press **OK** button.
- Enter **Gateway Address** (eg. 192.168.9.1), press **OK** button.  
**NOTE:** Press the \* key on the dial pad to enter the "." in the IP address.
- Skip [VLAN-PHONE], [VLAN-PC], [802.1x Setting] by pressing the **OK** button three times.
- Enter the **System IP address** (eg. 192.168.9.200), press **OK** button.
- Enter **System ID XXXX** (eg. 3201), then press **OK** button.
- Enter **Password XXXX** (eg. 1234) then press **OK** button.

Wait a second for the phone to reboot. The phone should register and authenticate itself to the phone system. Test SMT-i5210 for proper operation.

## SETTING UP HOT DESKING [IDLE LOGIN]

Hot Desking allows you to log in and out of your SMT-i5210 IP keyset without rebooting.

- Press the **Menu** soft button, scroll to **Phone** then press **OK** button.
- Scroll to **Phone Information** and press **OK** button.
- Enter the administrator's password (please contact your phone system administrator).
- Scroll to **Extension Login** then press **OK** button.
- Choose the **ON** option and press **OK** button. (Note: **On** to allow, **Off** to deny hot desking).
- Press the **Save** soft button to complete the setup.
- When the phone restarts, enter the **ID** (eg; extension 2809) and **password**.
- Press the **Save** soft button to complete the login.

# CONFIGURATION MENU STRUCTURE

The **Configuration Menu** options are as follows:

## 1. EASY INSTALL

This option will guide you through setting up all required parameters for connecting the SMT keyset to your system.

## 2. PHONE INFORMATION

1. Version Info: Provides boot rom, software, DSP, and hardware version information.
2. Network Info: Displays network mode, IP address of phone, network, and gateway information.
3. MAC Address

## 3. NETWORK

Displays Static IP, Dynamic IP, PPPoE, NAT, 802.1x, VLAN (LAN), and VLAN (PC).

## 4. SERVER

1. Primary System: The main processor's IP address.
2. System 1~3: Up to 4 server IPs can be set.

## 5. EXT. LOGIN

Allows the user to choose the option of permitting the phone either login/logout from idle mode or only register to the server on power up. Once the phone is placed into Extension Login mode, a display will show up to allow you to enter any valid User ID and password. This function is also referred to as hot desking (idle login).

## 6. S/W UPGRADE

1. TFTP Server: The IP address of the TFTP server containing the IP software.
2. Upgrade: Starts the IP software upgrade process.

## 7. FACTORY RESET

This option resets the SMT-i5210 to factory default settings.

## 8. PHONE RESTART

This option reboots the SMT-i5210 phone.

# SECTION 3. FREQUENTLY USED FEATURE OPERATION

This section provides the basic operation of your Samsung Multimedia Telephone **SMT-i5210**.

## EXTENSION LOG IN & OUT [HOT DESKING]

If enabled, your SMT-i5210 telephone may require you to log in before making or receiving calls. In these cases your telephone system administrator will provide you with an extension number, password, and the feature code used to log out.

### TO LOG IN

- Dial your extension number in the ID field (example 3201).
- Press the **OK** button.
- Dial your password in the password field (example 1234).
- Press **Save** soft button.



### TO LOG OUT

- Dial the feature code provided by your administrator (for example 77).

## PLACING CALLS

**IMPORTANT:** Put your phone in **Overlap Mode** by pressing the **Menu** button, select **Settings** and then select **Application Set.**, press **OK**, select **Call**, press **OK**, scroll to **Dial Mode**, change it to **Overlap** by using the Navigation Button. If your phone is not in Overlap mode you must always press the **Call** soft button after dialing the digits to send the call.

**NOTE:** All examples of making phone calls are based on the phone being set for overlap dialing mode.

**OUTSIDE CALLS** - To place a call to an outside party:

- Lift the handset.
- Press an idle outside line button, line group button, or dial a line access code to receive dial tone.
- Dial the telephone number.
- Hang up the handset when the call is completed.

**NOTE:** Frequently called telephone numbers can be added to the PhoneBook.

When making internal and external calls from AOM (programmable buttons) list, press the **AOM** soft button to access the programmable button screens. Then use the **Navigation** button to scroll to and highlight the desired programmable button. Press **OK** to complete the call.

**INTERNAL CALLS** - To place a call to another extension at your location:

- Lift the handset.
- Dial the extension number or group number.
- Wait for the party to answer. If you hear a brief tone burst instead of ringback tone, the station called is set for Voice Announce or Auto Answer. Begin speaking after the tone.
- Hang up the handset when the call is completed.

### NOTES:

1. If you have a **DSS** button assigned to an extension or station group, you may press this button instead of dialing the number.
2. If the Hot Keypad feature has been turned off, you must first lift the handset or press the **Speaker** button before you begin dialing.

**SPEAKERPHONE CALLS** - Your Samsung SMT-i5210 has speakerphone capability. This feature is used for both internal or external calls. To activate this feature:

- Press the **Speaker** button.
- Place an internal or external call.
- Press **Speaker** button to disconnect the call.

**NOTE:** The handset can be used at any time during the conversation. To resume handsfree operation, press the **Speaker** button, and hang up the handset.

**HEADSET CALLS** - If a headset is connected to the phone, you need to press the headset key to direct the call to the headset. The headset key will be lit. To use the headset:

- Press the **Speaker** button.
- Place an internal or external call.
- Press **Speaker** button to disconnect the call.

### NOTES:

1. If you need to switch between the headset and the handset during the call, you need to place the call on hold first.
2. Headset key can be enabled or disabled in the Menu, Settings, Application Setting, Headset.

## ANSWERING CALLS

**OUTSIDE/INTERNAL/VOICE ANNOUNCE CALLS** - To answer these three types of calls:

- Lift the handset or press the **Speaker** button to answer on Speakerphone.
- Hang up the handset when the call is completed.

**NOTE:** The volume can be adjusted at any time by pressing the up and down buttons on your navigation button.

## PLACING A CALL ON HOLD

Calls can be placed on **System Hold** or **Exclusive Hold**. A call placed on System Hold can be picked up from any extension. Calls placed on Exclusive Hold can only be picked up from the extension that placed them on hold.

**SYSTEM HOLD** - To place a call on hold:

- Press the **Hold** button. The **Call** button will flash green at your telephone.
- To take the caller off hold, press that button and the red flashing light will go steady red again.
- Resume conversation.

**EXCLUSIVE HOLD** - To place a call on hold at your telephone so that other users cannot answer it:

- Press the **Hold** button twice. The call button will flash green at your telephone.
- To retrieve the call, press the flashing red line button or press the line button a third time.

**NOTE:** Internal calls are always placed on exclusive hold.

## TRANSFERRING CALLS

You can transfer a call by notifying the party to which the call is being transferred or without notification.

- While on a call, press the **Transfer** button then dial an extension number.
- Confirm you hear a ringback tone.
- Wait for the called party to answer and announce the call (optional).
- Replace the handset.

## TRANSFERRING WITH CAMP-ON

When you transfer a call to another station and receive a busy signal, you can camp the call on to this station. Hang up when you hear the busy signal. The called party is alerted that a call is waiting.

- Call another internal station.
- When receiving a busy tone, press the **Func.** soft button.
- Scroll to **Camp On** and press **OK** button (here ringback tone). Wait for party to answer the call.

**NOTE:** If you receive No More Calls tone, that station has no button available to receive another call. Press **Transfer** to return to the caller.

## CALL WAITING

If an outside call is camped-on to your phone or another station is camped-on to you:

- Your keyset rings and the call that is waiting (camped-on) flashes red.
- Press the flashing button to answer; the other call is put on hold automatically if your station has the Automatic Hold feature set. If not, you must press **Hold** and then the flashing button or finish the first call and hang up; the waiting call will ring.
- Lift the handset or press the **Speaker** button to answer.

**NOTE:** Intercom calls will not go on Automatic Hold.

## CONFERENCE CALLS

To make a conference call while engaged in a conversation:

- Press the **Conference** button and receive conference tone.
- Make another call, either intercom or outside, press the **Conference** button and receive conference tone.
- Make another call or press the **Conference** button to join all parties. You can conference up to five parties (you and four others).
- Repeat the last step until all parties are added.
- Hang up to leave the conference call.

**NOTE:** When attempting to add another party to the conference and you are not able to reach the desired person, hang up. Simply press the **Conference** button again to return to the previous conversation.

**To drop a party from your conference call:**

- Press the **Conference** button and dial the extension or line number that is to be dropped.
- Press the **Conference** button again to reestablish the conference.



## FORWARDING CALLS Icon

You can forward your calls to another station, group of stations, or an external telephone number. Program a destination for the type of forwarding you want by moving the **Selector Switch** to the **left** and set the **forwarding number for All, Busy, No Answer, and Busy/No Answer**.

## OTHER FEATURES AND FUNCTIONS

**VOLUME CONTROL - Vol** button is used to adjust the volume of a handset, speaker and ringing sound.

### Volume Control of a Handset

- Adjusts the handset volume while busy (handset offhook).
- To increase the volume of a handset, press the top side [+] of the **Vol** button.
- To decrease the volume of a handset, press the bottom side [-] of the **Vol** button.

### Volume Control of a Speaker

- Adjusts the speaker volume while busy (handsfree).
- To increase the volume of a speaker, press the top side [+] of the **Vol** button.
- To decrease the volume of a handset, press the bottom side [-] of the **Vol** button while ringing.

### Volume Control of a Ringing Tone

- To increase the volume of a speaker, press the top side [+] of the **Vol** button, while ringing.
- To decrease the volume of a handset, press the bottom side [-] of the **Vol** button, while ringing.

### Volume Control of Key Tone

- To increase the volume of the key tones, press the top side [+] of the **Vol** button.
- To decrease the volume of the key tones, press the bottom side [-] of the **Vol** button.

**NOTE:** By pressing the **Vol** button in idle mode, the user can also adjust the key tone volume.

**LAST NUMBER REDIAL -** To redial the last dialed telephone number, press the **Func.** soft key scroll to **Last Redial** and press **OK**.

**PHONE BOOK BUTTON -** Provides direct access to the user's phonebook of stored contacts.

**MESSAGE BUTTON -** This function allows users to select which desired type of messages is viewed. Users can select and view the following options: **Voicemail Messages, Station Messages, E-Mail** (optional with IP-UMS only), and **Short Message Service** (SMS). Short Message Service is similar to sending text messaging [Function only supported on Samsung IP phones].

**SERVICE BUTTON [Scheduler] -** Used to allow station users access to setting and editing the scheduler (alarm clock) feature. Also used to connect the OfficeServ Communicator when application is available (UC is optional).

**MENU SOFT BUTTON-** This menu displays the following options:

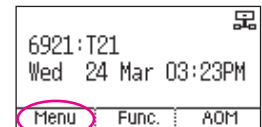

**NOTE:** The **Navigation** button can be used to scroll through these options.

1. **PHONEBOOK:** Maintains frequently dialed names and numbers in a PhoneBook. Search and initiate calls by: Speed Dial, Associated Names, Telephone Numbers, Assigned Groups, or Previous Calls registered to your phone.
2. **CALL LOG:** Provides direct access to a list of most recent calls, outgoing calls, incoming calls, missed calls, and an option to delete/delete all (or clear) calls from the **Call Log**.
3. **MESSAGES:** This function allows users to select which desired type of messages is viewed. Users can select and view the following options: **Voicemail Messages, Station Messages, E-Mail** (optional with IP-UMS only), and **Short Message Service** (SMS). Short Message Service is similar to sending text messaging [Function only supported on Samsung IP phones].
4. **CONFERENCE:** Allows a user to setup a **conference group** to call multiple parties simultaneously to join the conference call.
5. **SERVICE:** Allows a user to set the scheduler (alarm reminder) function.
6. **PHONE:** Allows the user to set many phone options for the phone such as ring tones, background screens, languages, forward, DND, etc.
7. **SETTINGS:** This function allows the user to set the following option: **Application Set., Call Forward, Absent Message, AOM Setting, Network Info., and Clear User Set.**

**FUNC. SOFT BUTTON** - This function allows a user one touch easy access to many of the system features. When pressed, the following options are displayed: **Last Number Redial, Save/Repeat, Speed Dial, Directory, VM Message, Station Message, Page Pickup, Direct Pickup, DND, In/Out Group, Status Message, Hold Pickup, Page, Meet Me Page, OHVA Block, Group Pickup, and My Group Pickup.** The **Navigation** button can be used to scroll up and down the list of features under the **Func.** button.

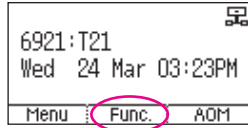

**NOTE:** **EXE/SECR MSG** is displayed only when the phone is programmed for Boss/Secretary feature.

**Example of using the Last Number Redial feature:**

- Press the **Func.** Soft button, scroll to **Last Redial**, then press **OK** button. The last number called from the phone is called.

**NOTE:** For detail operation of the list of features under the Func. soft button, please refer to the System Features section of the user guide.

**AOM SOFT BUTTON** - This function is used to display all 99 programmable feature buttons of the phone. The **Navigation** button can be used to scroll up and down the list of 99 programmable feature buttons under the soft AOM.

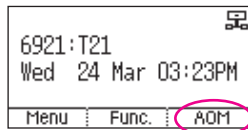

**Example of dialing a Speed Dial Number using the AOM function:**

- Press the **AOM** soft button, scroll to **Speed Dial**, then press **OK** button. The number is called from the phone.

**NOTE:** Some programmed features such as speed dialing and DSS buttons can be used to process calls; other programmed buttons such as Call buttons can only be viewed.

The soft AOM button can also display status indications for station keys, trunks, voice mail messages, etc.

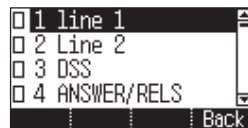

**Example of programming a DSS button on the soft AOM:**

- Press the **Menu** soft button.
- Using the **Navigation** button, scroll to **Settings** and press **OK**, then scroll to and select **AOM Setting**.
- Scroll to the soft **AOM** button to program (for example: 4).
- Press the **Edit** soft button (the display will show AOM index 4).
- Press **Edit** soft button again, scroll to the feature option (for example: DSS).
- Move down and enter the extension number (for example: 2003).

- Move down, use the dial pad to enter name (for example: John Dow). [Refer to Text Input Method.](#)
- Press the **Save** soft button to exit and save the setting.

**OK/ENTER BUTTON** - This function is used to enter, save or complete the selected option in the display.

**SPEAKER BUTTON** - This function is used to go on and off hook in the hands-free speakerphone mode.

## SECTION 4. PHONE FEATURES

# BASIC MENUS

The basic menus screen is displayed if you select the **Menu** from the soft menu at the left bottom of a idle screen. Using the **Navigation** button, move to a desired function, and press the **OK** button to execute the function.

## SOFT BUTTON STRUCTURE

### MENU SOFT BUTTON

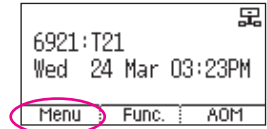

Item	Sub-Item	Description
<b>1. Phonebook</b>	All	Shows the entire list of phone numbers stored in the phone.
	Unassigned	This is a list of number that are not assigned any group.
	Search	Allows a user to search for a registered phone number by name/number.
	New	Saves a phone number or group name; and allows a user to specify a speed dialing number and ringtone.
	Edit [+]	Allows a user to delete all the phone numbers saved in the phone.
<b>2. Call Log</b>	Call	Used to make a callback from the call log.
	Save	This is used to save entries from call log to phonebook.
	[+] Delete	This is used to delete entries from the call log.
	Back	This is used to to move back one menu screen.
	Delete All	Allows a user to delete all the call history saved in the phone.
<b>3. Messages</b>	1. Voice Mail [0]	Allows a user to retrieve voice mail messages from the mailbox.
	2. Station Message [0]	Allows a user to retrieve station messages (internal) from another user.
	3. Email [0]	Allows a user to to view how many e-mail messages have been received via IP-UMS (optional).
	4. Short Message	Allows a user to retrieve and send internal short messages (SMS) like text message to other internal phones. <i>[Not Supported Over Networking]</i>

Item	Sub-Item	Description	
<b>4. Conference</b>		Allows a user to setup (show, add, and edit) a <b>conference group</b> to call multiple parties simultaneously to join the conference call.	
<b>5. Service</b>		Allows a user to set the alarm clock function.	
	1. Scheduler	Allows the user to set a timed reminder alarm to give an audible indication or alarm clock function.	
<b>6. Phone</b>		Allows the user to set many phone options for the phone such as ring tones, background screens, languages, etc.	
	1. UC Dial: Right	Options are <b>DND</b> and <b>Absent Message</b> .	
	2. Screen	Options are <b>Display Time, Time Format, Font,</b> and <b>LCD Power</b> .	
	3. Sound	Options are <b>Volumes, Ring Tone,</b> and <b>Key Tone</b> .	
	4. Language	Multiple languages are available.	
	5. Security	Change <b>Password, Dial</b> and <b>Phone Lock</b> .	
	6. Phone Information		<b>Easy Install:</b> Used to register and authenticate the phone to the server.
			<b>Phone Information:</b> Includes Version Info, Network Info, and MAC Address.
			<b>Network:</b> Options are Static IP, Dynamic IP, PPPoE, VLAN (LAN Port), VLAN (PC Port), 802.1x.
			<b>Server:</b> Used to register the phone to one or more Servers. Options are Primary, System 1, System 2, and System 3.
		<b>Extension Login:</b> Used to log phone on and off (Hot Desking).	
		<b>S/W Upgrade:</b> Upgrade Server, Upgrade: used to upgrade software on phones.	
		<b>Factory Reset:</b> Used to default the phone settings.	
	<b>Phone Restart:</b> Used to reboot the phones.		

Item	Sub-Item	Description
<b>7. Settings</b>		This function is used to allow station users to set <b>application settings</b> , call forwarding, absent messaging, AOM setting, view station network information, view phone firmware or initialize the phone. Other settings include the following:
	<i>Note: All options are not explained in this manual. The options are initiative and menu driven for an easy, user friendly menus to guide you through navigating the Setting Menu Options.</i>	
	1. Application Set.	Options are <b>Call</b> (CID 1, CID 2, Dial Mode), <b>Phone Name, Boss Answer, Short Message, Station On/Off,</b> and <b>Extension Login</b> .
	2. Call Forward	Options are <b>Not Use, All, Busy, No Answer, Busy/No Answer, DND,</b> and <b>Follow Me Status</b> .
	3. Absent Message	Used to leave <b>station messages</b> in display informing other internal parties of your status when your station is called.
	4. AOM Setting	Used to set the name, number, and function to the <b>99 AOM buttons</b> .
	5. Network Info.	Used to view the current <b>network settings</b> .
6. Clear User Set.	<b>Clear</b> your local setting such as <b>phone-book, call log,</b> etc.	

# 1. PHONEBOOK

**NOTE:** Personal phonebook is stored locally in phone memory.



## All

Shows the entire list of phone numbers saved in the phone book.

- Press the **Phonebook** button—**OR**—press the **Menu** soft button, scroll to **Phonebook**, press **OK**, scroll to **All**, and then press **OK**.
- The entire list of phone numbers saved in the phone book is shown on the screen. Using the **Navigation** button, move to a desired number, and select the **Call** soft button to place a call.

## Unassigned Group

The Unassigned option is a list of all the phonebook entries that have not been assigned to a group. Once an entry is assigned to a group, the entry is removed from the unassigned list.

## TO CREATE A PHONEBOOK GROUP

To create a group in the phonebook:

- Press the **Phonebook** button, then press the [+]  
soft button, then press the **New** soft button.
- Using the key pad, input the name of the group, then press the **Save** soft button. [See Text Input Method.](#)
- Press **Edit** soft button or press **Back** soft button to exit.

## TO MOVE UNASSIGNED ENTRY TO PHONEBOOK GROUP

- Press the **Phonebook** button, scroll to **Unassigned** option then press **OK** button.
- Scroll to the entry that is to be moved to an assigned group and press **OK** button.
- Press **Edit** soft button, scroll to and highlight the **Group** option.
- Using the Navigation button, move **Left** or **Right** to the group name (eg; Personal) which you want to move the entry into.
- Once the correct entry is displayed, press the **Save** button. The entry is now assigned to the group.

## Search

Allows a user to search by name/number for a phone saved in the phone book.

- Press the **Phonebook** button—**OR**—press the **Menu** soft button, scroll to **Phonebook**, press **OK**.

- Press the **Search** soft button from the dial pad enter the characters of the name (case sensitive) or number to search and press the **OK** button, the matching phone number is displayed. Move to a desired name/number using the **Navigation** button, and select the **Call** soft button to place a call.

## Add New Entry to Phonebook [+]

This is the function used to register a phone number.

- Press the **Phonebook** button—**OR**—press the **Menu** soft button, scroll to **Phonebook**, press **OK**.
- Press the [+]  
soft button, and then **New**.
- Enter a **name** by using the dial pad, scroll down and enter a **mobile number, home number, office number, internal extension number, fax number, and e-mail address**.
- Assign a **Group** (if needed).
- Select a **Ring Tone**.
- Add **Memo** information (up to 50 characters).
- Press the **Save** soft button to save the new entry to the Phonebook.

## DELETE/DELETE ALL

This is the function used to delete all the phone numbers saved in the phonebook.

- Press the **Phonebook** button—**OR**—press the **Menu** soft button, scroll to **Phonebook**, press **OK**.
- Scroll to **All** and press **OK** button. Scroll to entry to delete.
- Press [+]  
soft button. Press **Del.** to delete the selected entry in the chosen group.
- Press the **Yes** to **Delete All** entries in the chosen group.

# 2. CALL LOG

 **Outgoing**  **Incoming**  **Missed Icons**

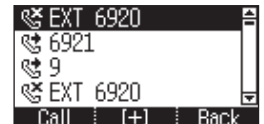

This function lists all the recent numbers for outgoing, incoming and missed calls.

- Press the **Menu** soft button, scroll to **Call Log**, press **OK**. A phone number list of recent outgoing, incoming and missed calls is displayed.
- Scroll to an entry and press the **Call** soft button to dial the number.

## VIEWING DETAIL CALL LOG RECORD

To view the details of each of the call log entry, highlight the entry and press the **OK** button to display the full Caller ID record which includes the name, date and time.

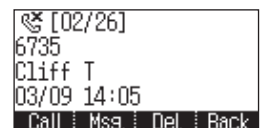

## DELETE / DELETE ALL

This is the function used to delete an entry or all entries in the Call Log.

- Press the **Menu** soft button, scroll to **Call Log**, press **OK**.
- Scroll to entry to delete.
- Press **[+]** soft button. Press **Del.** to delete the selected entry or **Del All**.
- Press the **Yes** to **Delete** entry.

## TO ADD A CALL LOG ENTRY TO PHONE BOOK

- Press the **Menu** soft button, scroll to **Call Log**, press **OK**. Scroll to desired **Call Log Entry** and press the **Edit** soft button. Make changes to the name and number if necessary. When finished, press the **Save** soft button. The Call Log number is added as a new entry to the phonebook list.

## 3. MESSAGES

### 1. Voice Mail

This function allows users to retrieve voice mail message from the mailbox.

- Press the **Message** button—OR—press **Menu** soft button, scroll to **Messages**, press **OK**, scroll to **Voice Mail [ ]**, and then press **OK** to access the voicemail box and retrieve messages.

### 2. Station Message

This function allows users to retrieve station messages (internal) from another user.

- Press the **Message** button—OR—press the **Menu** soft button, scroll to **Messages**, press **OK**, scroll to **Station MSG [ ]**, and then press **OK**.
- To return a call to the station that left the message: press the **Func.** soft button, scroll to **Reply**, then press **OK**.
- To delete the station message: press the **Func.** soft button, scroll to **Clear**, then press **OK**.
- To view the next station message: press the **Func.** soft button, scroll to **Next**, then press **OK**.

### 3. E-Mail

This function allows users to view the amount of e-mails for a station user's account. This function is only available when the IP-UMS application is enabled. Please refer to the IP-UMS manuals for detailed operation.



1	Voice Mail	[1]
2	Station Message	[0]
3	Email	[0]
4	Short Message	[0]
	End	
		Back

## 4. Short Message (SMS)

This function is used to send and create internal short messages or text messaging.

### INBOX

- Press the **Message** button—OR—press the **Menu** soft button, scroll to **Short Message**, press **OK**.
- Scroll to **Inbox**, then press **OK** to view a short text message in you Inbox.
- Press the **[+]** soft button, press **Del.** soft button, and the **Yes** soft button to delete the selected short text message or press the **Back** soft button to exit Short Message.

### NEW MESSAGE (SEND)

This function is used to create and send a new short text message.

- Press the **Message** button—OR—press the **Menu** soft button, scroll to **Short Message**, press **OK**.
- Press **New Msg** soft button. Write or create a new short message and press the **Next** soft button. [See Text Input Method on how to enter characters in text messages.](#)
- Enter the internal extension(s) to send the short message. Scroll to other entries and enter the station number to send to more users. (Each short message can be sent to 1 through 10 users).
- Press the **Send** soft button to deliver the short message to other user's inbox.

### NOTES:

1. When the message is sent successfully, the message "Sent" is displayed. When the message fails to send the "Failed to send" is displayed.
2. SMS messages can only be sent to internally ITP, SMT-W, or SMT-i phones. TDM and single line phones cannot send or receive SMS messages. SMS messaging is not supported over networking.

### OUTBOX

This function is used to create and send a new short text message.

- Press the **Message** button—OR—press the **Menu** soft button, scroll to **Message**, press **OK**.
- Scroll to **Outbox**, then press **OK** to view short text message sent from your phone.
- Press the **[+]** soft button, then **Del/Del All** soft button to delete the short text message(s) or press the **Back** soft button to exit SMS.

## 4. CONFERENCE [Group]

This function allows a user to setup a conference group to call multiple parties simultaneously to join the conference call.



### CREATING CONFERENCE GROUP

- Press the **Menu** soft button, scroll to **Conference**, and press **OK**.
- Press **New** soft button, enter phone number (up to 4 numbers) of the parties included in the Conference Group.
- Press the **Call** soft button to initiate the Conference Group.

### TO CREATE AN UNSUPERVISED CONFERENCE

- During the conference, the host can press the **Host** soft button.
- The host is dropped and the other parties remain in conference.

### TO DISCONNECT A PARTY FROM CONFERENCE GROUP

- Highlight the party to be disconnected from the conference group.
- Press the **Disc.** soft button. The party is disconnected.
- Press the **Call** soft button to call back and add the party back to the conference group.

### SAVING A CONFERENCE GROUP

- After completing the group conference, press the **Save** soft button.
- Enter the **Name of the Group**, and press **Save** soft button.

### TO EDIT A CONFERENCE GROUP

- Press the **Menu** soft button, scroll to **Conference** button, and press **OK**.
- Scroll to the **Name of the Group** to be edited and press **Edit** soft button.
- Edit the group name. When complete, press the **Save** soft button to save changes.

### TO EDIT CONFERENCE GROUP PHONE NUMBER LIST

- Press the **Menu** soft button, scroll to **Conference** button, and press **OK**.
- Scroll to the **Name of the Group** to be edited and press **Edit** soft button.
- Press the **Edit** soft button. Edit the phone number list—**OR**— Press **Search** soft button to search for phone number to add to group from the phonebook. Highlight the entry and press the **OK** button to add the number to the Conference Group list.
- When complete with the editing, press the **Save** soft button to save changes.

## 5. SERVICE

Allows a user to set the alarm clock function.



- Press the **Service** button—**OR**—press the **Menu** soft button, scroll to **Scheduler**, then press **OK**.
- Press the **New** soft button.
- Enter the name of the scheduler using the dial pad and navigation buttons.
- Press the **Next** soft button. Enter the Date, Time, Alarm Type, and Ring Tone. Press **Save** soft button when finished.

### TO DELETE A SCHEDULE

- Press **Menu** soft button. Scroll to **Service** button, and press the **OK** button.
- Select **Scheduler** and press the **OK** button.
- To delete a current schedule, press the **[+]** soft button.
- Select and highlight the entry to be deleted and press **Delete** soft button—**OR**—press the **Delete All** soft button to clear all schedules.
- Select **Yes** to confirm or **No** to deny the deletion of a schedule(s).
- Press **Back** and **End** soft buttons to exit the scheduler.

## 6. PHONE

Allows the user to set many phone options for phone such as ring tones, background screens, languages, etc.

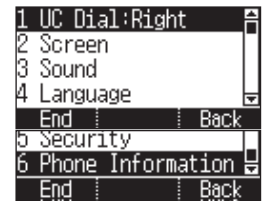

### 1. UC Dial: Right

This option is used to select which function will be enabled when the selector switch is moved to the right position.

- Press the **Menu** soft button. Scroll to **Phone** and press **OK**.
- Scroll to **UC Dial: Right** and press **OK**.
- Select **DND** or **Absent Message** and press **Save** soft button.

### 2. Screen

- Press the **Menu** soft button. Scroll to **Phone** and press **OK**. Select **Screen** and press **OK**. Set the following **Time Format**, **Font**, and **LCD Power Saving** of the SMT-i5210 phone, select the option and adjust the screen settings.
- Press the **Save** soft button to save the screen settings.

### 3. Sound

- Press the **Menu** soft button. Scroll to **Phone** and press **OK**. Select **Sound** and press **OK**. Set the following **Volumes**, **Ring Tone**, and **Key Tone** of the SMT-i5210 phone, select the option and adjust the sound settings.
- Press the **Save** soft button to save the sound settings.

#### 4. Language

- Press the **Menu** soft button. Scroll to **Phone** and press **OK**. Select **Language** and press **OK**. Select English (Default English).
- Press the **Save** soft button.

#### 5. Security

- Press the **Menu** soft button. Scroll to **Phone** and press **OK**. Scroll to **Security** and press **OK**.
- Enter the station password [default 1234].
- Press **OK** to Change Password and press **Back** soft button.
- Scroll to **Dial** to **Unlock**, **Lock Out** (Outgoing), or **Lock All**.
- Scroll to **Phone** to **Unlock** or **Lock** the Menu.
- Press the **Save** soft button.

#### 6. Phone Information

Allows a user to set up the following options: **Easy Install Wizard** (registering the phone), **Phone Info** (Version, Network, MAC Address), **Network** (Static, Dynamic, etc.), **Server** (Phone can register to 1 to 4 servers), **Extension Login** (logging in and out IP phones), **Software Upgrade** (Upgrading the phone or server software), **Factory Reset** (defaulting the phone), and **Phone Restart** (rebooting the phone).

### 7. SETTINGS

This function is used to allow station users to set **Application Settings**, **Call Forward**, **Absent Message**, **AOM Setting**, **Network Information**, and to **Clear User Settings** such as Call Log and Phonebook.



### FUNC. SOFT BUTTON

This function allows a user one touch easy access to many of the system features. When pressed, the following options are displayed: **Last Number Redial**, **Save/Repeat**, **Speed Dial**, **Directory**, **VM Message**, **Station Message**, **Page Pickup**, **Directory Pickup**, **DND**, **In/Out Group**, **Status Message**, **Hold Pickup**, **Page**, **Meet Me Page**, **OHVA Block**, **Group Pickup**, and **My Group Pickup**. The Navigation button can be used to scroll up and down the list of features under the **Func.** button.

**NOTE:** [For detailed operation of the list of features under the Func. soft button, please refer to the System Features section of this user guide.](#)

### AOM SOFT BUTTON

This function is used to display all 99 programmable feature buttons of the phone. The Navigation button can be used to scroll up and down the list of 99 programmable feature buttons under the AOM module. The feature buttons can be programmed by a technician.

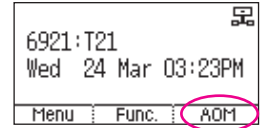



## SECTION 5. OFFICESERV™ 7000 SYSTEM FEATURES

### OUTSIDE CALLS

#### MAKING CALLS FROM AOM

**Note:** When making calls, internal or outside calls, in order to access the programmable button screens, press the AOM soft button. Then you can utilize the **Navigation** button to scroll the list.

- When the desired number is highlighted, press the **OK** button.
- The number will be automatically dialed.

#### UNIVERSAL ANSWER

Outside lines may be programmed to ring a general alerting device. To answer calls ringing this device, dial **67**—**OR**—press the **UA** button. This device can operate in any one of the six different ring plans.

**NOTE:** If the Hot Keypad feature has been turned off, you must first lift the handset or press the **Speaker** button before dialing.

#### RECALL DIAL TONE

- Press the **New** button to disconnect your existing call, wait for dial tone and then make a new call on the same line.

**NOTE:** If this button does not appear on your keyset, the **Flash** button may be programmed to recall dial tone.

#### SENDING A FLASH

While on an outside call, press the **Flash** button to send a flash to the telephone company. This is required for some custom calling features or CENTREX use.

**NOTE:** Flash is not available on an ISDN circuit.

#### BUSY LINE QUEUING WITH CALLBACK

If you receive a busy signal when you are selecting an outside line, this means that the line or group of lines is busy.

- Press the **Callback** button, if programmed, or dial **44**, you will hear confirmation tone.
- Hang up or press **Speaker** button.
- When the line becomes free, the system will call you back.
- Lift the handset or press the **Speaker** button to answer, wait for dial tone and dial the telephone number or speed dial number again.

#### NOTES:

1. A callback will be canceled if not answered within 30 seconds. If you have set a callback, the cursor associated with the **Callback** button will be solid black.
2. If the Hot Keypad feature has been turned off, you must first lift the handset or press the **Speaker** button before dialing.

## BUSY STATION CALLBACK

When you call another station and receive a busy signal:

- Press the **Callback** button, if programmed, or dial **44**.
- When the busy station becomes free, your keyset will ring.
- Lift the handset or press the **Speaker** button to call the now idle station.

#### NOTES:

1. A callback will be canceled if not answered within 30 seconds. If you have set a callback, the cursor associated with the **Callback** button, will be solid black.
2. If the Hot Keypad feature has been turned off, you must first lift the handset or press the **Speaker** button before dialing.

## CANCELING CALLBACK

A callback will be canceled if not answered within 30 seconds. If you have set a callback, the cursor associated with the **Callback** button, will be solid black.

To cancel a callback:

- Press the **Callback** button, if programmed, or dial **44**. The display will show the callback details, press the **Func.** soft button and then **Clear**.
- This will cancel the last set callback and display the next set callback, also with the option to **Clear**. This process is repeated until all callbacks are cleared from memory.

NOTE: If the Hot Keypad feature is turned off, you must first lift the handset or press the **Speaker** button before dialing.

## BUSY STATION CAMP-ON

When you call another station and receive a busy signal but you do not want to wait for a callback:

#### MANUAL CAMP-ON

- Press the **Camp** button or dial **45**.
- The called station will receive off-hook ring tone repeated every few seconds and the cursor associated with the first available **Call** button will flash black to indicate your call is waiting.
- Wait for the called party to answer.

- The called station must release its first call or place it on hold before answering your camp-on.

#### NOTES:

1. If you receive No More Calls tone, that station has no available button to accept your call. Hang up or leave a message.
2. If the Hot Keypad feature has been turned off, you must first lift the handset or press the **Speaker** button before dialing.

#### AUTO CAMP-ON

When you want to automatically camp on to a busy station without pressing the camp on button every time you call a busy station, you can set your phone for auto camp-on.

- With the handset on-hook, press **Transfer** and then dial **110**.
- Dial **081** to turn **On** auto camp-on, or dial **080** to turn it **Off**.
- Press **Transfer** to store your selection.

# INTERCOM CALLS

## VOICE ANNOUNCE MODE

When another station calls you, your keyset will sound a brief attention tone and you will hear the caller's announcement.

- Press the **Speaker** button to turn on the microphone and speak handsfree—**OR**—lift the handset to reply.
- To finish the call, replace the handset or press the **Speaker** button.

NOTE: In order for C.O. calls to be answered handsfree, AUTO ANS CO must be set to ON.

## AUTO ANSWER MODE

When another station calls you, your keyset will sound a brief attention tone and then automatically answer the call.

- Your microphone and speaker are turned on and you can speak handsfree. For privacy, use the handset.
- To finish the call, replace the handset.

NOTE: In order for C.O. calls to be answered handsfree, AUTO ANS CO must be set to ON.

## CALLING YOUR SYSTEM OPERATOR

- Dial **0** to call your system operator or group of operators.
- If you want to call a specific operator, dial that person's extension number.

NOTE: If the Hot keypad feature has been turned off, you must first lift the handset or press the **Speaker** button or dial **0** before you begin dialing.

# CALL PROCESSING

## SYSTEM HOLD

When you are connected to any call, press **Hold**. The call will flash at the keyset. If this call appears on a line button at other keysets, it will flash at those keysets also.

- To take the caller off hold, press that button and the flashing LED will go steady again. Resume the conversation—**OR**—press the **Hold** button. The flashing LED will go steady again and you will be connected to the call again. Resume the conversation.

NOTE: While on a call, pressing a line button, route button or flashing **Call** button will automatically put your first call on hold and connect you to the new call. [See Automatic Hold under Customizing Your Keyset.](#)

## EXCLUSIVE HOLD

To place an outside call on hold at your phone so that other users cannot get it:

- Press the **Hold** button twice. The call will flash on your keyset and this line will show a steady indication on other keysets.
- To retrieve the call, press the flashing line button or press the **Hold** button a third time.

NOTE: Intercom calls will always be placed on exclusive hold.

## REMOTE HOLD

When you wish to place a call on hold at another station.

- Press **Transfer** and dial the station number (or press the appropriate **DSS** button)
- Press the **Hold** button. This will place the call on system hold on an available **Call** button or Line button at the remote station and return you to dial tone.

NOTES:

1. If the destination station does not have any free **Call** buttons or line buttons you will hear No More Calls tone and must return to the other party by pressing the **Transfer** button.
2. Intercom calls cannot be put on remote hold.

## HOLD RECALL

If you leave a call on hold longer than the hold timer, it will recall your station. The button that the call appears on will have a slow flashing indicator.

- When your phone rings, lift the handset or press the **Speaker** button to answer the recall.
- If you do not answer this recall within a pre-programmed period of time, it will go to the system operator.

NOTE: The Led will flash amber during hold recall.

## CONSULTATION HOLD

When you are talking on an outside line and it is necessary to consult with another extension:

- Press the **Transfer** button; you will receive transfer dial tone. Your call is placed on transfer hold.
- Dial the extension number.
- Consult with the internal party.
- Press **Transfer** to return to the outside party or hang up to transfer the call.

NOTE: Repeatedly pressing the **Transfer** button will toggle between the outside party and internal extension. If necessary you may disconnect either one of the parties by pressing the **Func.** soft button, then press the **Cancel** soft button.

## RETRIEVING CALLS HELD AT ANOTHER STATION [HOLD PICKUP]

When a line is on hold and it appears on your keyset, press the **Line** button with the flashing indicator.

When a line is on hold and it does not appear on your keyset, dial **12** plus the line number or the extension number of the station that placed the call on hold.

NOTE: If the Hot Keypad feature has been turned off, you must first lift the handset or press the **Speaker** button before you begin dialing.

## CALL TRANSFER

Transfer is used to send any calls to another extension in one of two ways. You can do a screened transfer by informing the other extension who is calling or you can do a blind transfer without notification.

- While on a call, press the **Transfer** button and dial an extension number or group number. Your call is automatically put on transfer hold—**OR**—press a **DSS** button or station group button. Your call is automatically put on transfer hold.
- Hang up when you hear ringing (this is an unscreened or blind transfer)—**OR**—wait for the called party to answer and advise him/her of the call and hang up. If the transfer is refused, you will be reconnected to the outside line when the called station hangs up or you can press **Transfer** to return to the outside party.
- If you wish to send the call to another extension without waiting for the first station to hang up, simply press another **DSS** button—**OR**—press the **CALL** button or C.O. line button to return to the outside party and begin the transfer process again.
- When you are transferring a call to a keyset set for Voice Announce or Auto Answer, the transferred call will always ring.

NOTES:

1. After the inside party answers, you may alternate back and forth between the parties by pressing the **Transfer** button.
2. If you receive No More Calls tone, that station has no button available to receive another call. Press **Transfer** to return to the other party.
3. You cannot transfer an Intercom call by pressing a **DSS** button. You must press the **Transfer** button and dial the destination extension number.

## TRANSFER WITH CAMP-ON

When you are transferring a call to another station and you receive a busy signal, you may camp the call on to this station. Simply hang up when you hear the busy signal. The called party will be alerted that a call is waiting for them.

NOTE: If you receive No More Calls tone, that station has no button available to receive another call. Press **Transfer** to return to the outside caller.

## TRANSFER TO VOICE MAIL

This feature is used to send a call directly to a voice mailbox. Your keyset must have a correctly programmed **VT** button to accomplish this. To transfer a call directly to a voice mailbox:

- While on a call, press the **VT** button and dial the mailbox number.
- Hang up when dialing is completed.

## CALL WAITING

If an outside call has been camped-on to your phone or another station has camped-on to you:

- You will hear a tone in the earpiece and the call that is waiting for you (camped-on) will flash. In addition the bottom line of the display will indicate the number of the station or trunk party camped-on.
- Press the flashing button to answer; your other call will go on hold automatically if your station has the Automatic Hold feature set. If not, you must press **Hold** and then the flashing button—**OR**—finish the first call and hang up; the waiting call will ring.
- Lift the handset or press the **Speaker** button to answer.

NOTE: Intercom calls will not go on Automatic Hold. When using the speakerphone the camp-on tone will come through the speaker.

## CALL FORWARD OPTIONS

A display keyset may review or change call forward options and destinations. Call forward access can be done via the keypad or by accessing the keyset display features. To review or change call forward options:

- Press the **Menu** button, scroll to **Settings**, press the **OK** button.
- Scroll to **Call Forward** and press the **OK** button.
- Scroll to the desired Forwarding option, enter the destination extension, and press the Save soft button.  
—**OR**—
- Press **Transfer 102**.
- Dial **0-5** to select the forward type (e.g., 1)—**OR**—  
Press **Volume Up** [+] or **Volume Down** [-] to select the forward type  
Press the right soft key to move the cursor.
- Dial the destination number (e.g., **202**)—**OR**—  
Press **Volume Up** [+] or **Volume Down** [-] to select the destination and press the **Right** soft key to move the cursor.
- Dial **1** to set—**OR**—press **Volume Up** [+] or **Volume Down** [-] to select **Yes** or **No** and press **Transfer** to store and exit.  
—**OR**—

### To Forward ALL Calls to Another Station

- Dial **601** plus the extension or group number.
- Receive a confirmation tone and hang up.

### To Forward Calls to Another Station when you are on the Phone (BUSY):

- Dial **602** plus the extension or group number.
- Receive a confirmation tone and hang up.

### To Forward Calls to Another Station when you DO NOT ANSWER:

- Dial **603** plus the extension or group number.
- Receive a confirmation tone and hang up.

### When you have both Forward ON BUSY and Forward NO ANSWER Destination Programmed:

- You can activate them simultaneously.
- Dial **604**. Receive a confirmation tone and hang up.

### To Forward Calls when DND is Activated:

- Dial **605** plus the extension or group number.
- Receive a confirmation tone and hang up.

### To Forward Calls to the Station Where You Currently Are (FORWARD FOLLOW ME):

- Dial **606** plus the extension or group number.
- Receive a confirmation tone and hang up.

To clear all call forward conditions set at your station lift the handset and dial **600**.

## STATION CALL PICKUP

To pick up (answer) a call ringing at another station, lift the handset and dial **65** plus the extension number of the ringing phone. If you have a DP key assigned with a station number, you only need to press this **DP** (Direct Pickup) key with the flashing light to answer this ringing station. NOTE: If the Hot Keypad feature has been turned off, you must first lift the handset or press the **Speaker** button before you begin dialing.

## GROUP CALL PICKUP

To pick up (answer) a call ringing in any pickup group, lift the handset and dial **66** plus the desired group number (**01-10** on the **OfficeServ 7030**, **01-20** on the **OfficeServ 7200-S**, **01-99**, and **01-99** on the **OfficeServ 7000 Series**) or press the flashing **Group Pickup** button if available.

### NOTES:

1. A group pickup button can have an extender for a specific pickup group.
2. If the Hot Keypad feature has been turned off, you must first lift the handset or press the **Speaker** button before dialing the access code.

## MY GROUP PICKUP

If desired, a new access code can be assigned to pickup ringing calls in the same pickup group as you are in. Like "66" above except you do not need to dial the desired group number. See your installation company for the assigned access code. MY GROUP PICKUP: \_\_\_\_\_.

## PRIVACY RELEASE

This feature will allow another station to join in our conversation by releasing privacy on the C.O. from your phone.

**To Release Privacy:** While you are talking on a C.O. line and you wish to have other internal parties (or up to three) join the conversation.

- Press the **PRB** button (the **PRB** indicator will be steady). Inform the other party that he/she may now join the conversation.

After the other party (or parties) has joined the conversation and you wish to return privacy to the line so that no one else can join the conversation, press the **PRB** button a second time, the **PRB** button LED will be off.

**To Join a Non-Private Conversation:** When someone has informed you that you can join a conversation:

- Press the **C.O. line** button that he/she has indicated—**OR**—
- Dial the **C.O. line number** that he/she has indicated.

## DIALING FEATURES

All "DIALING FEATURES" instructions are written to support Overlap Dialing mode. This is the technical name for dialing from a telephone as it has been for many years. In recent years the cell phone industry has changed the cell phones to use Enblock Dialing. With this dialing mode all the digits are dialed and then sent to the carrier after pressing the **CALL** button. Please check your telephone setup to confirm what dialing mode is used.

## SPEED DIALING

You can dial a preprogrammed telephone number stored in the system-wide speed dial list of numbers 500–999 or from your personal list of numbers 00–49.

Your system may be set for 950 system wide numbers. If so the system speed dial access codes are 050~999 and the station speed dial codes are 000~049.

- From the idle screen with the handset on-hook, press the **AOM** soft button, scroll to the **Speed Dial** button, press the **OK** button or dial **16**.
- Dial the desired speed dial number.
- The telephone number is automatically dialed for you.

NOTE: If the Hot Keypad feature has been turned off, you must first lift the handset or press the **Speaker** button before you begin dialing.

## PROGRAMMING PERSONAL SPEED DIAL NUMBERS

You can program frequently dialed telephone numbers in a personal speed dial list. A station may be assigned up to fifty numbers, **00–49**. See your system administrator to determine the amount assigned to your station. The phone itself maintains 1000 station speed dial numbers.

- While on-hook, press **Transfer** and then dial **105**.
- Dial a speed dial number (**00–49**).
- Dial a line or line group access code.
- Dial the telephone number to be stored (24 digits maximum). It can include #, \*, FLASH and PAUSE.
- Press **Transfer** to store the number.

NOTE: If the Hot Keypad feature has been turned off, you must first lift the handset or press the **Speaker** key before you begin dialing.

For the purposes of programming speed dial numbers, the programmable buttons are known as **A**, **B**, **C**, **D**, **E**, and **F**.

- The **A** button is not used.
- The **B** button inserts a flash.
- The **C** button inserts a pause.
- The **D** button is used for pulse to tone conversion. If your system uses rotary (or pulse) dialing C.O. lines, pressing **D** while entering a speed dial number causes all subsequent digits to be sent as DTMF tones.
- The **E** button is used to hide digits. Display keyset users may want to hide some speed dial numbers so that they will not show in the display. When you are entering a telephone number, press **D**. All subsequent digits will be hidden. Press **E** again to begin displaying digits.
- The **F** button is used to enter a speed dial name or number. [See Personal Speed Dial Names under Display Features.](#)
- Use the **Hold** button to clear a speed dial number.



## DIRECTORY DIALING

- Press the **Func.** soft button, scroll to **Directory**, press **OK**.
  - Press **Func.** soft button, scroll to the desired **directory**, press **OK**.
- STATION DIRECTORY** - Accesses Station name directory.  
**PERSONAL DIRECTORY** - Accesses your personal speed dial name list.  
**SYSTEM DIRECTORY** - Accesses System speed dial name list.
- Enter the first letter of the desired party.
  - Press the +/- buttons to scroll to the desired entry.
  - Press the **Func.** soft button.
  - Select the appropriate operation, press **OK**.
- DIAL** - Dials the displayed number.  
**EXIT** - Exit programming and return to idle screen.  
**PREVIOUS** - Moves you to the previous entry.  
**NEXT** - Moves you to the next entry.
- Press **Back** to return to idle screen.

## LAST NUMBER REDIAL

To redial the last outgoing telephone number you dialed, press the **Func.** soft button, scroll to **Last Redial**, or dial **19**.

NOTES:

1. If the Hot Keypad feature has been turned off, you must first lift the handset or press the **Speaker** button before you begin dialing.
2. Redial does not apply to intercom calls.

## SAVE NUMBER WITH REDIAL

To save the number you just dialed for later use, press the **Save/Repeat** button before hanging up.

To redial this saved number at any time, press the **Func.** soft button, scroll to **Save/Repeat**, press **OK** button or dial **17**. The same line will be selected for you.

NOTES:

1. If the Hot Keypad feature has been turned off, you must first lift the handset or press the **Speaker** button before you begin dialing.
2. The saved telephone number is stored in memory until you save another number.
3. Redial does not apply to intercom calls.

## AUTOMATIC REDIAL/RETRY

When you are making an outside call and you receive a busy signal, the system can automatically redial the number for you. It will automatically redial at a pre-programmed interval for up to 15 attempts.

- When you hear a busy signal, press the **Retry** button.
- The system will reserve the line and automatically redial the same number for you. You will hear the call being made through the keyset speaker. The microphone is muted.
- When the called party answers, lift the handset or press the flashing **Speaker** to begin speaking.

NOTES:

1. If you make another call, auto-redial is canceled.
2. To cancel an auto-retry, lift and replace the handset.

## PULSE TO TONE CHANGEOVER

When making an outside call on a dial pulse line, press #. All digits dialed after the # will be sent as tones.

# PAGING AND MESSAGING

## MAKING AN INTERNAL PAGE

To make an announcement through the keyset speakers in the idle condition:

- Lift the handset.
- Press the **Func.** soft button, scroll to **Page** button, press **OK** or dial **55**.
- Dial the desired zone number **0, 1, 2, 3** or **4**.
- After the attention tone, make your announcement.

### NOTES:

1. If you have a dedicated page zone button, it is not necessary to press **Page** and dial a zone number.
2. If allowed by your system administrator you may be able to initiate a page from a speakerphone by pressing the **Page** key or dialing **55** without lifting the handset.

## MAKING AN EXTERNAL PAGE

To make an announcement through the external paging speakers:

- Lift the handset.
- Press the **Func.** soft button, scroll to **Page** button, press **OK** or dial **55**.
- Dial the desired zone number **5, 6, 7** or **8**—**OR**—dial **9** to page all external zones.
- After the attention tone, make your announcement.

### NOTES:

1. If you have a dedicated page zone button, it is not necessary to press **Page** and dial a zone number.
2. If allowed by your system administrator you may be able to initiate a page from a speakerphone by pressing the **Page** key or dialing **55** without lifting the handset.

## ALL PAGE

To page all designated keysets in internal zone 0 and all external zones at the same time:

- Lift the handset.
- Press the **Func.** soft button, scroll to **Page** button, press **OK** or dial **55**.
- Dial **\*** or press the **All Page** button.
- After the attention tone, make your announcement.

### NOTES:

1. The LED on the **Page** button will only light when an All Page is in progress.
2. If allowed by your system administrator you may be able to initiate a page from a speakerphone by pressing the **Page** key or dialing **55** without lifting the handset.

## MEET ME PAGE

- Lift the handset.
- Press the Meet Me Page (**MMPG**) button or dial **54**.
- Dial the desired zone number (0~9).
- After the attention tone, instruct the paged person to dial **56**.
- Press **Func.** soft button, then **Answer Wait**, then press **OK**.
- Remain off-hook until the person dials **56** from any phone.
- The paged person will be automatically connected with you.

## CALL PARK AND PAGE

When you have an outside call for someone who is not at his/her desk, you can park the call prior to paging. The OfficeServ 100, OfficeServ 500, and OfficeServ 7000 Series systems offer two different methods:

### MANUAL PARK ORBITS

- While in conversation, press the **Park** button.
- Entered a desired orbit number (**0-9**), if the orbit number is busy dial another orbit number. Display users can press **\*** to automatically place the call in any available orbit number and see the number in the display.
- Remember the selected orbit number.
- Replace the handset when finished.
- Lift the handset and make a page announcement as previously described (example: "John Smith park two").

### To retrieve a parked call from orbit:

- Press the **Park** button and dial the announced orbit number (**0-9**).
- You will be connected to the parked call.

### NOTES:

1. You must have a **Park** button or park access code to retrieve and place calls in park orbits.
2. If the parked call is not retrieved within a pre-programmed period of time, it will recall your keyset and have a slow flashing amber light. You cannot park and page intercom calls.
3. If the Hot Keypad feature has been turned off, you must first lift the handset or press the **Speaker** button before you begin dialing.



## AUTOMATIC PARK WITH PAGE BUTTON

- While in conversation, press the **Page** button. The call is automatically parked at your station.
- Receive page tone and dial a desired page zone number.
- Make announcement indicating your extension number or the line number. Hang up.

### To retrieve an automatically parked call:

- Dial **10** plus the number that was announced. If you have a **PAGPK** button, press it and dial the number that was announced. If you have a **PARK** button, press it and dial the announced orbit number.
- You will be connected to the parked call.

### NOTES:

1. If the call is not retrieved within a pre-programmed period of time, it will recall your keyset and have a slow flashing amber light. You cannot park and page intercom calls.
2. If the Hot Keypad feature has been turned off, you must first lift the handset or press the **Speaker** button before you begin dialing.

## SETTING A MESSAGE INDICATION

When you are calling another station and no one answers or you receive a busy signal, you can leave a message indication:

- Press the **Func.** soft button, scroll to **Message**, press **OK—OR—dial 43** and receive confirmation tone. Hang up.
- The message button on the Main Programmable Button screen and the TSI will flash red at the called station.

### NOTES:

1. A station can have up to five message indications.
2. If the Hot Keypad feature has been turned off, you must first lift the handset or press the **Speaker** button before you begin dialing.

## CANCELING MESSAGES

To cancel a message indication that you left at another station, dial **42** plus the extension number of the station at which you left a message.

- To cancel all message indications left at your keyset, dial **42** plus your extension. Your **Message** button indicator will stop flashing and the TSI will go out.

NOTE: If the Hot Keypad feature has been turned off, you must first lift the handset or press the **Speaker** button before you begin dialing.

### —OR—

- Press **Message** button, scroll to **Station Messages**, press **OK**.
- Press **Func.** soft button, scroll to **Clear**, press **OK**.

## RETURNING MESSAGES

- Press **Menu**, scroll to **Message**, press **OK**, scroll to **Station Message**, press **OK**, press **Func.** soft button, press **Reply**, and then press **OK**, or dial **43**. The first station that left a message will be called automatically. If that station does not answer, the called station **Message** button indicator will continue to flash and the TSI will stay on.
- Repeat until all messages have been returned in the order received.
- Your **Message** button indicator will stop flashing and the TSI will turn off when all messages have been returned.

### NOTES:

1. Display keyset users can view message indications and return them in any order. [See Viewing Message Indications under Display Features.](#)
2. If the Hot Keypad feature has been turned off, you must first lift the handset or press the **Speaker** button before you begin dialing.
3. If a message has been left at your keyset by a keyset in Auto Answer, you must manually cancel the message after it has been returned.

## PROGRAMMED MESSAGES

When you will be away from your phone for any length of time, you can leave a programmed station message. Display stations calling you will see this message and be informed of your status or follow your instructions.

- Dial **48** plus any of the message codes (**01–20**) listed on the back of this user guide.
- To cancel any of these messages you might have selected, dial **48** plus **00**.
- Press **Transfer** to exit and store your selection.

NOTE: If the Hot Keypad feature has been turned off, you must first lift the handset or press the **Speaker** button.

You can have multiple programmed message buttons (**PMSG**) and each one can have a different message code:

- Press any programmed message (**PMSG**) button. The message is set and the PGM MSG button indicator will be lit steady. Press the button again to turn off the programmed message and the indicator will go blank.
- Pressing another programmed message (**PMSG**) button will turn the previous one off and set a different programmed message.

# CONVENIENCE FEATURES

## LOGGING IN AND OUT

If enabled, your SMT-i5210 telephone may require you to log in before making or receiving calls. In these cases your telephone system administrator will provide you with an extension number, password, and the feature code used to log out.

### To log in:

- At **Extension Login Screen** enter your ID which is your extension number.
- Scroll down to the password field and enter your station password
- Press on **Save** soft button or **OK** button.

### To log out:

- Dial the feature code provided by your administrator (for example 77).

## DO NOT DISTURB

Use this feature when you want to block calls to your keyset.

- While on-hook, press the **Func.** soft button, scroll to **DND**, press **OK**, press **1** to turn it **On**, or dial **401**. The **DND** button indicator will be lit steady to remind you of this mode.
- To cancel **DND**, press the **Func.** soft button, scroll to **DND**, press **OK**, press **0** to turn it **Off**, or dial **400**. The **DND** button indicator goes blank. You can make calls while in the DND mode.

### NOTES:

1. If the Hot Keypad feature has been turned off, you must first lift the handset or press the **Speaker** button.
2. If you place your keyset in **DND** mode and you do not have a **DND** button, your **TSI** button will fast flash red to indicate DND status.
3. The **Selector Switch** can also be used to set DND.

## ONE TIME DND

If you are on a call and you do not wish to be interrupted while on that call, you can press the **DND** button and place your station in Do Not Disturb. When you hang up at the end of the call, DND will be automatically canceled and your keyset will be able to receive new calls. This feature requires a **DND** button.

## MUTE

You can mute the handset transmitter or the microphone during any conversation:

- Press the **Mute** button. The **Mute** button indicator will be lit steady.
- To resume speaking, press the **Mute** button again. The **Mute** button indicator goes blank.

## BACKGROUND MUSIC

When a music source is supplied, you may listen to music through the speaker in your keyset:

- While on-hook, press the **Hold** button to hear music.
- Press the **Hold** button again to turn music off.

You can set the level of background music by using the **Volume** buttons while listening to the music. This does not affect the speakerphone level.

## ESTABLISHED CALL PICKUP

To pick up an established call in progress at a single line extension connected to a computer modem on your PC.

- Press the **EP** button for that station on your keyset and the call is automatically moved to your keyset.
- The single line extension on your modem will be disconnected.

NOTE: You must have an assigned (**EP** button) button on your regular keyset, for the single line station.

## ANSWERING THE DOOR PHONE

When you are programmed to receive calls from a door phone:

- You will receive three short rings repeated.
- Lift the handset. You are connected to the door phone.
- If an electric door lock release is installed, dial **13** to unlock the door.

## CALLING THE DOOR PHONE/ ROOM MONITOR

You may call the door phone and listen to what may be happening outside or in another room.

- Dial the extension number of the door phone.
- You will be connected to the door phone and you can listen or have a conversation.
- If an electric door lock release is installed, dial **13** to unlock the door.

NOTE: If the Hot Keypad feature has been turned off, you must first lift the handset or press the **Speaker** button.

## EXECUTIVE/SECRETARY [HOT LINE]

If programmed, an executive boss and a secretary can have a hot line between them. When the executive station is in the DND mode, all of its calls will ring the secretary station. If the secretary does not answer, the caller will go to the secretary's voice mail box if setup.

When an Executive/Secretary hotline is programmed to this keyset, the keyset offers an additional screen option. This screen has options for setting the status of the keyset user. This status update is viewable to EasySet users only.

- Either person can press the **Boss** button to make a voice call to the other station.
- Using the hot line will override DND at the other station. This button will have a flashing indication when the other station is in use.

### To transfer a call to a Boss in DND:

- Press the **Boss** button.
- Wait for the **Boss** to answer, then announce the call and hang up to complete the transfer—**OR**—hang up to complete a blind transfer.

### Executive/Secretary (Messaging):

When the Boss or Secretary is needing to inform the other party of their current status, they can send a message to their display.

- Press the **Func.** soft button. Scroll to **EXE/SECR MSG** and press **OK**.
- Select and highlight one of the **Return On** messages and press the **Edit** soft button.
- Press and hold the **Delete** soft button to erase the default message.
- Using the dial pad, type in the new message ([refer to Text Input Method](#)).
- When finished press the **Save** then the **Send** soft button to display the message on the other (Boss/Secretary) phone.

## GROUP LISTENING

When you are engaged on a call and you are using the handset, you may want other people to hear the distant party's voice over the speaker:

- Press the **Listen** button to turn on the speaker. The microphone is not in use, so the distant party does not hear other parties present in your office.
- Press **Listen** again to turn the speaker off and resume private conversation.
- Repeat if necessary.  
—**OR**—
- During a conversation, press **Func.** scroll to **Group Listen** and press **OK**.

NOTE: Depending on speaker volume and the acoustics of your office, it may be advisable to turn the group listening feature off before hanging up. This will eliminate a momentary squeal.

## ACCOUNT CODES

When enabled, your system allows calls to be charged to different accounts. You can enter account codes either by dialing the full code, by entering an account code "**bin number**", or by pressing your **ACC (Account)** key if one is assigned. Bin numbers are a 3 digit short code that will automatically insert the appropriate account code. Account codes may be a maximum of 12 digits (# may be used); if the account code is to be less than 12 characters you may end the code by pressing **\*** or the right soft key. The type of code used is determined by your telephone system administrator. Codes can be entered before or during a call as follows:

### To enter an account code before placing the call:

- Press your **ACC (Account)** key or dial **47**.
- Dial the account code or bin number.
- You will receive a confirmation tone and display.
- When prompted dial a trunk or trunk group (i.e. 9) and the telephone number to call.

### To enter an account code by interrupting the conversation:

- While on an outside call press the **ACC (Account)** key or press **Transfer** followed by **47**.
- Dial the account number or bin number (if you are entering an account code you will need to press your **ACC (Account)** key or right soft key to finalize the entry)

NOTE: If you make an error simply repeat the procedure with the correct code. Only the most recent account code dialed will be recorded.

## LOCKING YOUR KEYSSET

You can lock your keyset to control misuse of your phone while you are away. You can unlock it when you return.

- Press **Menu** button, scroll to **Phone**, press **OK**.
- Scroll to **Security** option. Press **OK**.
- Enter the **Password** [Default Password is "1234"]. Press **OK**.
- There are three options available:

**CHANGE PASSWORD:** This can be used to change the station password.

**DIAL:** Allows the station user the option to select **Lock All**, **Lock Outgoing**, or **Unlocked**.

1. **UNLOCKED** - No restrictions. User may complete internal and outside calls.
2. **LOCK OUTGOING** - Restricted to incoming calls only. No outside calls can be made. When 911 is programmed, 911 emergency dialing is allowed.
3. **LOCK ALL** - No calls, incoming or outgoing allowed to or from the set.

**PHONE MODE:** Allows the user to lock or unlock the menu from being changed at the station.

- Use the navigation soft button to scroll **Left/Right** to choose the desired mode.
- Press the **OK** button.
- Press the **Back** soft button to return to **Menu**, and press **Back** soft button again to return to idle screen.

## MANUAL SIGNALLING

Use this feature when you want to send a brief 500ms ring burst to another station, regardless of the status of your phone (on-hook, off-hook, handsfree, DND, or ringing).

**To send a signal to another station:**

- Press the Manual Signalling (**MS**) button.
- You may press the **MS** button repeatedly to send multiple signals to the designated station.

NOTE: Your phone must have a Manual Signalling (MS) button with a station number extender assigned to it. Manual Signalling will override DND.

## OFF-HOOK VOICE ANNOUNCE

Keysets may receive a voice announcement while on another call. The calling station must have an **OHVA** button. When you are in DND, you cannot receive OHVA calls. The OHVA feature will work with intercom and transferred calls.

When you receive an OHVA and secure OHVA is ON, you will hear the announcement in the handset receiver, if you are using the handset. If secure OHVA is OFF then you will hear the announcement on the speaker, if you are talking on the handset. If you are using the speakerphone the announcement will always be heard through the speaker.

**To make an off-hook voice announcement:**

- Dial the extension number or press the **DSS** button.
- When you receive a busy signal, press the **OHVA** button.
- After the attention tone, begin speaking.
- Finish the call by replacing the handset.
- Press the flashing **Call** button on your keyset. This will place the original party on hold and allow you to talk to the announcing party.
- To return to your first party, press the button corresponding to your original call. This will disconnect the OHVA call.

NOTES:

1. When you are voice announcing to a station close to you, use the handset to avoid an echo effect.
2. You cannot off-hook voice announce to single line telephones.

## OHVA BLOCK

Your keyset can be programmed with an OHVA Block (**Block**) button. Pressing this button will prevent anyone from making an OHVA to you until you press the button again and cancel the blocking.

## OHVA REJECT

Your keyset can be programmed with an OHVA Reject (**Reject**) button. Pressing this button while receiving an OHVA call will disconnect the voice announcing party and return you to your original call.

## IN GROUP/OUT OF GROUP

If your keyset is assigned to a station ring group, you can remove your keyset from the group and then put it back in. While you are out of the group, you can receive calls to your extension number but not calls to the group number. If you have an **IO GRP (IN/OUT GRP)** button with the group number assigned.

- Press the **IO GRP (IN/OUT GRP)** button. The button indicator will be lit steady when your keyset is in the group.
- Press the **IO GRP (IN/OUT GRP)** button again to exit the group and the indicator will go blank. Repeat as necessary.

If you do not have an **IO GRP (IN/OUT GRP)** button:

- Dial the **IO GRP (IN/OUT GRP)** access code number \_\_\_\_\_, then the group number, then **0** to exit the group or **1** to enter the group.

NOTE: If the Hot Keypad feature has been turned off, you must first lift the handset or press **Speaker** button.

The **IO GRP (IN/OUT GRP)** button can include an extender to indicate the specific group that this button will affect. This means that if you are in multiple groups, you can decide for which groups you will receive calls.

## CUSTOMIZING YOUR KEYSSET

### AME PASSWORD

This feature allows customers using the AME feature to enable password protection. This will prevent unauthorized users from listening to your messages being left. The passcode is the same as your station passcode. This feature only applies if there is a Samsung Voicemail card installed in the system and your keyset has a programmed AME button.

- With the handset on-hook, press **Transfer** and then dial **110**.
- Dial **101** to turn on AME PASSCODE or **100** to turn it off.
- Press **Transfer** to store your selection.

### AUTO CAMP-ON

This option allows intercom calls to be automatically camped on, if possible, when a busy station is called.

- With the handset on-hook, press **Transfer** and then dial **110**.
- Press **081** to turn Camp-On on or **080** to turn it off.
- Press **Transfer** to store your selection.

### SELECT RING TONE

Each SMT-i5210 user can select from a variety of ring tones.

**From the LCD:**

- Press **Menu** button, scroll to **Phone**, press **OK**.
- Scroll to **Sound** option and press **OK**.
- Select **Ring Tone** and press **OK—OR—**you may dial **1** and immediately enter the option.
- Use **Navigation** button to scroll through the available ring tones and press **OK** or **Save** soft button to store your selection.
- Press **End** soft button to return to idle screen.

### CHANGE YOUR PASSCODE

From the factory, your station passcode is 1234. You can change your station passcode whenever you desire.

- While on-hook, press **Transfer** and then dial **101**.
- Dial your old passcode.
- Dial a new passcode (must be four characters). You can use **0-9**.

- Redial the new passcode. If successful, you will hear two beeps. Four beeps indicate an incorrect code to confirm, reenter the code again.
- Press **Transfer** to store the new passcode.

## SET ANSWER MODE (INTERCOM)

You can receive internal calls in one of three modes ([see Answering Intercom Calls under Intercom Calls](#) for descriptions).

- While on-hook, press **Transfer** and then dial **103**.
- Dial **0** for Ringing, **1** for Auto Answer or **2** for Voice Announce.
- Press **Transfer** to store your selection.

NOTE: When your keyset is programmed for Voice Announce and you have Forward No Answer (FNA) turned on, you must answer screened transfers by pressing the **OK** button before your FNA timer expires or the call will forward.

## SET ANSWER MODE (CO)

Your incoming CO calls can be set to follow the intercom answer mode.

- While on-hook, press **Transfer** and then dial **110**.
- Dial **15** to access **AUTO ANS CO**.
- Press the **Volume Up** [+] or **Volume Down** [-] to change status (**ON/OFF**).
- Press **TRANSFER** to store your selection.

## AUTOMATIC HOLD

While on an outside call, pressing a line button, route button or a flashing **CALL** button will automatically put your call on hold and connect you to the next call. This feature can be turned on or off at your keyset.

- With the handset on-hook, press **Transfer** and then dial **110**.
- Dial **001** to turn Automatic Hold on or **000** to turn it off.
- Press **Transfer** to store your selection.

## HEADSET OPERATION

Keyset users can switch between headset mode and handset mode. When using headset mode, press the **Speaker** button to answer and **Speaker** button to release calls.

- With the handset on-hook, press **Transfer** and then dial **110**.
- Dial **021** to use the headset or **020** to use the handset.
- Press **Transfer** to store your selection.

Your keyset is equipped with a **Headset** button. Pressing this button while the indicator is off will cause the keyset to enter headset mode and the button indica-

tor to be lit solid to indicate this. Pressing the button while the button indicator is lit solid will cause the keyset to return to handset mode and the button indicator will go off.

NOTE: If you need to switch between headset mode and handset mode (or speaker phone) during the conversation, you will need to put the call on hold first.

## HOT KEYPAD

On your phone system your keyset's keypad can be made "live" or "hot" so that it is not necessary to lift the handset or press the **Speaker** button before you begin dialing. Calls can be made and features activated by simply dialing the C.O. line number, trunk group access code, intercom number or feature access code.

- With the handset on-hook, press **Transfer** and then dial **110**.
- Dial **031** to turn the Hot Keypad on or **030** to turn it off.
- Press **Transfer** to store your selection.

## KEY CONFIRMATION TONE

You can hear a short beep (confirmation tone) each time you press a button on the dial pad. This tone can be turned on or off.

- While on-hook, press **Transfer** and then dial **110**.
- Dial **040** to turn tones off or **041** to turn tones on.
- Press **Transfer** to store your selection.
- Additional ring tones can be selected from the **Menu, Phone, Sound, Keytone** option.

## REJOINING A PAGE

This feature allows you to hear the remaining portion of an ongoing internal page after you return your keyset to idle. To enable this feature:

- With the handset on-hook, press **Transfer** and then dial **110**.
- Dial **051** to turn this feature on or **050** to turn it off.
- Press **Transfer** to store your selection.

## RING PREFERENCE

This feature automatically answers ringing calls when you lift the handset or press the **Speaker** button. This method will always answer calls in the order they arrived at your keyset. When you turn ring preference off, you must press the flashing button to answer a call, allowing you to answer calls in the order you choose.

- With the handset on-hook, press **Transfer** and then dial **110**.
- Dial **061** to turn ring preference on or **060** to turn it off.
- Press **Transfer** to store your selection.

## DISPLAY SPEED DIAL NAME

This option allows you to view the name associated with a speed dial number as it is dialed.

- With you handset on-hook, press **Transfer** and then dial **110**.
- Press **111** to turn **DISP SPDNAME** on or **110** to turn it off.
- Press **Transfer** to store your selection.

## CALLER ID REVIEW ALL

This feature allows display keyset users to review Caller ID information for calls sent to their stations. This list can be from ten to fifty calls in a first in, first out basis. The list includes calls that you answered and calls that rang your station but that you did not answer. When reviewing this list, you can press one button to dial the person back. The system must be using LCR to dial the stored number.

- With you handset on-hook, press **Transfer** and then dial **110**.
- Press **121** to turn **CID Review All** on or **120** to turn it off.
- Press **Transfer** to store your selection.

## SECURE OHVA

This option allows you to receive OHVA (Over Head Voice Announce) calls via the speaker while you are on the handset.

- With your handset on hook, press **Transfer** and then dial **110**.
- Press **131** to turn **SECURE OHVA ON** or **130** to turn it **OFF**.
- Press **Transfer** to save your selection.

## CONFIGURE MOBILE EXTENSIONS [MOBEX]

This feature allows you to configure options for any Mobile Extension (MOBEX) ports that are assigned to you by your telephone system administrator. You can turn a port on or off; set the telephone number for the port; or set the caller ID you will be calling in from. The caller ID field has no effect unless you have been authorized as an Executive MOBEX user. Check with your telephone system administrator for further details on your specific system configuration.

### To set the phone number a MOBEX port can reach you on:

- Press **Transfer** and then dial **126**.
- Dial your station pass code.
- Dial the number of the port you wish to configure (1-5) (you may also use the **Volume Up** [+] or **Volume Down** [-] keys to select a port and press the **Right** soft key to confirm).
- Press **Right** soft button to move to telephone number.

- Dial the number of a C.O. line or trunk group to use when making calls to this MOBEX port.
- Dial the phone number you can be reached at by users calling this MOBEX port.
- Press **Transfer** to store your selection and exit programming.

### To set the caller ID of the location you will be calling in from:

- Press **Transfer** and then dial **126**.
- Dial your station pass code.
- Dial the number of the port you wish to configure (1-5) (you may also use the **Volume Up** [+] or **Volume Down** [-] keys to select a port and press the **Right** soft key to confirm).
- Press **Right** soft button twice.
- Dial the contact number.
- Press **Transfer** to store your selection and exit programming.

### To turn a MOBEX port ON or OFF:

- Press **Transfer** and then dial **126**.
- Dial your station pass code.
- Dial the number of the port you wish to configure (1-5) (you may also use the **Volume Up** [+] or **Volume Down** [-] keys to select a port and press the **Right** soft key to confirm).
- Dial **2** to select the activation status option.
- Dial **0** to turn the port on, dial **1** to turn the port off.
- Press **Transfer** to store your selection and exit programming.

# DISPLAY FEATURES

## DIRECTORY INFORMATION

An 11 character directory name can be assigned to each extension number. Display keyset users can view the name of the called or calling station before answering.

Each outside line can have an 11 character directory name. Incoming calls can be easily identified and answered with different greetings.

Outside and internal calls ringing to a station group will display [CALL FOR xxx] where xxx is the station group number. This allows you to answer calls directed to you differently than calls directed to your group.

## DISPLAY NUMBER DIALED

Display keysets begin showing digits as they are dialed. They will stay in the display until the call duration timer comes on automatically or the **Timer** button is pressed. If the call duration timer is not used, the number dialed will be displayed until the call is released, transferred or put on hold.

## CALL DURATION TIMER

The system can be set to automatically time outside calls. A few seconds after you dial a telephone number, the timer appears in the display. It appears immediately for incoming calls. The call timer continues for the duration of the call. Call duration times are displayed in minutes and seconds. If a call lasts longer than 60 minutes, the timer restarts.

You can press the **Timer** button to manually begin timing a call. Press it again to stop timing. If you press it while the automatic timer is on, the call duration time is restarted.

## AUTO TIMER

Display keyset users may have the timer automatically start when they answer incoming calls or after a short delay on an outgoing call.

- With the handset on-hook, press **Transfer** and then dial **119**.
- Dial **41** to turn the auto timer on or **40** to turn it off.
- Press **Transfer** to store your selection.

## TIMER FUNCTION

Display keyset users may use this feature as a simple stopwatch.

- When the keyset is idle, press the **Timer** button to start timing.
- Press the **Timer** button again to stop timing.
- Read the elapsed time in the display.
- Lift the handset and replace it. The display will return to date and time.

## VIEWING STATION MESSAGE INDICATIONS

You can view all of your message indications before you return them:

- With the handset on-hook, press the **Message** button with the flashing indicator.
- The first station that left a message indication will be displayed.
- Press the **Volume Up** [+] or **Volume Down** [-] buttons to scroll through the stations that left message indications. Use the soft keys to reply, clear or advance to the next message.
- Press the **End** button to return your keyset to the idle condition.

## PERSONAL SPEED DIAL NAMES

Each personal speed dial number can have an 11 character name assigned to it. This name is used to select the speed dial bin when you are dialing by directory.

- Press **Transfer** and then dial **106**.
- Dial the speed dial bin number **00–49**.
- Using the dial pad, enter the station name ([See Station Names](#)).
- Press the **Transfer** button to store the speed dial name.
- Repeat for each speed dial bin if necessary.

NOTE: Use the Navigation button to move the cursor left or right, and use the **Volume Up** [+] or **Volume Down** [-] buttons to increment the speed dial bins.

[See Programming Personal Speed Dial Numbers Section.](#)

## STATION NAMES

- With the handset on-hook, press **Transfer** and then dial **104**.
- Enter the **Station Name**. Use the **Volume Up** [+] or **Volume Down** [-] buttons to move cursor.
- Press **TRANSFER** to store the name.  
—OR—
- Press **Menu** button, select **Settings**, press **OK**.
- Select **Application Set.**, press **OK**.
- Select **Phone Name**, press **OK**.



- Enter **Station Name**. Use the **Volume Up** [+] or **Volume Down** [-] buttons to move cursor.
- Press **Save** soft button and then **End** soft button to store the name.

## MANAGING PROGRAMMABLE KEY ASSIGNMENTS

You can manage your key assignments for easy one touch operation of frequently used features.

- While on-hook, press **Transfer** and then dial **107**.
- Use the **Volume Up** [+] or **Volume Down** [-] buttons to scroll through all of your programmable buttons.
- Press **Transfer** to exit programming.

To program the programmable keys, press **Menu, Settings, AOM Setting**.

For example:

**If you want to press a key that will direct calls to Joel at extension 3201.** Select an empty key and set the following:

- Feature: DSS
- Ext. Number: 3201
- Display Name: Joel

**If you want to press a key that will direct calls to Sue's external phone number at 972-444-3456.** Select an empty key and set the following:

- Feature: Speed
- Ext. Number: 01
- Display Name: Sue
- Use Transfer 105 to set speed dial number: [xxxx] SPEED DIAL  
01: 9-9724443456

Please consult your installation company to requested a complete list of descriptions for any keys you may have programmed on your keyset.

NOTE: Confirm that the cursor is placed correctly before you enter the extender.

## BACKSPACE WITH LCR

If you misdial while using LCR, you can delete digits shown in the display by pressing the **Backspace** soft key as many times as necessary or by pressing **Clear** to delete all.

# CALLER ID

## SELECTING YOUR CALLER ID DISPLAY

Simultaneous display of Caller ID name and number on incoming CO calls on both lines of display keysets is supported on all OfficeServ systems. On Transferred CO calls, you can decide if you want to see the Caller ID name or Caller ID number in the display. Regardless of which data is selected, you can press the NND button to view the other pieces of Caller ID information. To select the type of Caller ID information you wish to view:

- With the handset on-hook, press **Transfer** and then dial **119**.
- To set the first line of a ringing call display dial **0**.
- To set the second line of a ringing call display dial **1**. Set the data to display from the following:
  - To show nothing dial **0**.
  - To show Caller ID Number dial **1**.
  - To show Caller ID Name dial **2**.
  - To show the DID Number the call came in on dial **3**.
  - To show the Name of the DID the call came in on dial **4**.
  - To show the Name of the Group the call came in for dial **5**.
  - To show the DID Number and then Name of the DID dial **6**.
  - To show the Name of the DID and then the DID Number dial **7**.
- To set the top line of the display shown after answering a call dial **2**. Set the data to display from the following:
  - To show Caller ID Number dial **0**.
  - To show Caller ID Name dial **1**.
  - To show the DID Number the call came in on dial **2**.
  - To show the Name of the DID the call came in on dial **3**.
  - To show Caller ID Number and then the DID Number dial **4**.
  - To show Caller ID Name and then the DID Number dial **5**.
  - To show the DID Number and then the name of the DID dial **6**.
  - To show the Name of the DID and then the DID Number dial **7**.
  - To show the C.O. line information dial **8**.
- To set the format if the C.O. line information when the above is set to show C.O. line information dial **3**.
  - To show the C.O. line number and the dialed or Caller ID Number dial **0**.
  - To show only the dialed or Caller ID Number dial **1**.
- Press **Transfer** to exit and store your selection.

## VIEWING THE NEXT CALLER ID CALL

In the event that you have a call waiting or a camped-on call at your keyset, you can press the **Next** button to display the Caller ID information associated with the call in queue at your keyset. Either the CID name or CID number will show in the display depending on you Name/Number selection.

To view Caller ID information for calls that have been camped-on to your keyset, press the **Next** button.

## INQUIRE CALLER ID PARK/HOLD INFO

If you are informed that an incoming call is on hold or has been parked for you, you may view the Caller ID information before you retrieve the call. This may influence how you choose to handle the call.

### From an idle keyset:

- Press the **Inquire** button—**OR**—press **CID** button, then **Func.** soft button, and the **Inquire** soft key.
- Dial the trunk number.
- You may now answer the call by pressing the **ANS** button—**OR**—you may use **Func.** soft button and **NND** to view more information about this call—**OR**—you can return to the idle condition by pressing **Ignore**.

### If you are on a call:

- Press the **Func.** soft button and then **Inquire** button. Your existing call will go on hold—**OR**—press the **CID** button and **Func.** soft button then **Inquire** soft button to place the first call on hold.
- Dial the trunk number.
- You may now answer the call by pressing the **Func.** soft button then the **ANS** button—**OR**—you may use **NND** to view more information about this call—**OR**—you can return to the idle condition by pressing the **Func.** soft button and then **Ignore**.

### NOTES:

1. If you are on an intercom call or you have Automatic Hold turned off, you must finish the existing call or place it on hold before inquiring.
2. If you inquire about an outgoing call, you will receive a [call no longer available] display.

## FEATURE ACCESS CODES

### Paging Zones - Dial 55 plus

0	_____
1	_____
2	_____
3	_____
4	_____
5	_____
6	_____
7	_____
8	_____
9	All External Zones
*	All Page

### Feature Access Codes

0	Operator	56	Meet Me Answer
10 + xxx	Pick Up A Parked Call	600	Cancel All Call Forward
12 + xxx	Pick Up a Held Call	601 + xxx	Set Forward All Calls
13	Door Lock Release	602 + xxx	Set Forward Busy
16 + xxx	Speed Dialing	603 + xxx	Set Forward No Answer
17	Save And Redial Number	604 + xxx	Set Forward Busy/No Answer
18	New Call (Recall)	605 + xxx	Set Forward on DND
19	Last Number Redial	606 + xxx	Set Forward Follow Me
400	Cancel Do Not Disturb	65 + xxx	Pick Up Ringing Extension
401	Do Not Disturb	66 + xx	Pick Up Group
42 + xxx	Cancel Sent Message	67	Universal Answer
43	Return Message	*	Authorization Code
44	Callback		
45	Busy Station Camp-On		
46	Conference		
47	Account Code		
48 + xx	Cancel Programmed MSG		
49	Send Flash to C.O. or PBX		
53 + xxx + 1	In Group		
53 + xxx + 0	Out of Group		

## SECTION 6. APPLICATIONS

### Samsung Voicemail

This section describes how to setup and use the various features available to a Subscriber. A Subscriber is a person that has been authorized access to the various features and services available in the Samsung Voicemail. Please review this section carefully before you use your Authorized Features and Services, known as Subscriber Services.

Voice Mail is one of the Subscriber Services available. Your voice mail box has the capability of storing private messages, and offers a number of options for sending or redirecting messages as well as provides several ways to notify you of new messages.

Another very common Subscriber Service is Access Manager. This allows you control over when and where you receive your calls as well as what to speak to your callers in the event you are unable to speak to them directly. The 'events' are referred to as "Call Conditions". No-Answer, Busy, and Blocked are the most commonly used Call Conditions.

This guide can be used by Subscribers from within the office or from telephones outside the office. The basic operation is the same, but the access method will be different. [See the Subscriber Services Menu Diagram for more details.](#)

Note that some features and prompts detailed here may not be available to all Subscribers. See your System Administrator if you have questions about feature availability.

# Subscriber Services Menu

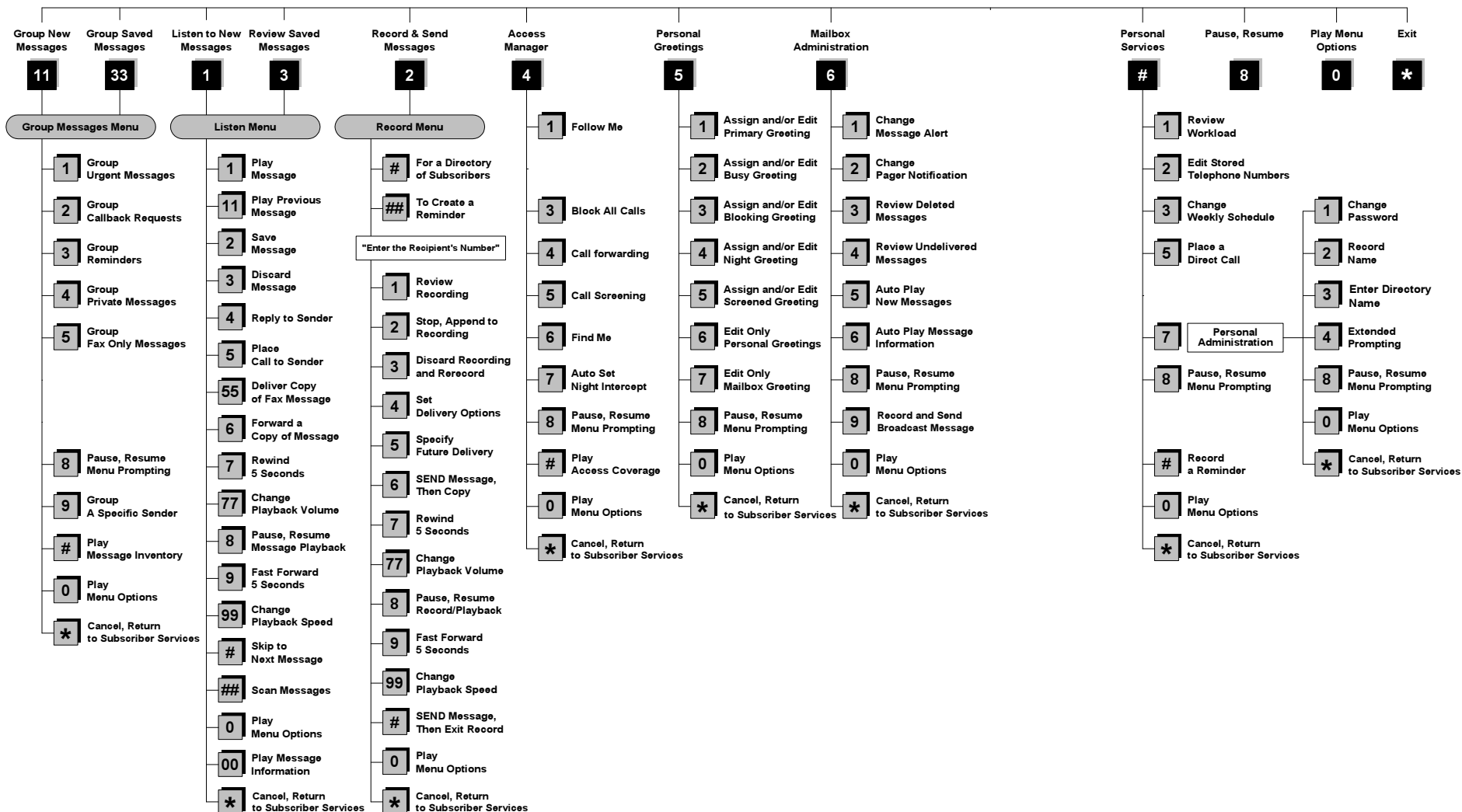

NOTE: All options shown MAY NOT be authorized. If an option is not available please speak to your system administrator.  
 \*Change Playback Speed and Volume not available on the OfficeServ 7030, OfficeServ 7100, OfficeServ 7200-S or OfficeServ IP-UMS.

## ACCESSING YOUR MAILBOX

*[Also known as Subscriber Services Menu]*

### Inside Callers *[Subscriber logging in from their Desk]*

- Dial the voicemail access number or press the key assigned to ring voicemail **[VMMMSG]**.
- Enter your personal password when prompted (the default password is 0000).

### Outside Callers *[Subscribers calling from Cell Phones or outside of the office environment]*

- Dial the phone number that will be answered by the voicemail. The main greeting will answer.
- At the main greeting dial **[#]** plus your Subscriber (or mailbox) number (Subscriber and Mailbox numbers will usually match your extension number).
- Enter your personal password when prompted (the default password is 0000).

### Access your Subscriber Services (or Mailbox) from a Station other than your Own (or checking a mailbox associated with a different station)

- Press the **[VMMMSG]** key or dial the voicemail **group number**. You will be prompted to enter a password.
- Press **[\*]**. This will take you to the Main Auto Attendant Menu.
- Press **[#]** plus the Subscriber number of your choice. You will be prompted to enter your password.

At this point the inside and outside callers follow the same instructions. You will hear a message stating the number of messages left in your mailbox. You will then hear the Subscriber Services Menu with the following options:

- 1 Listen to New Messages - [See Listening to your Message.](#)**
- 2 Record and Send Message - [See Sending Messages.](#)**
- 3 Review Saved Messages - [See Listening to your Message.](#)**
- 4 Access Manager - [See Access Manager.](#)**
- 5 Personal Greetings - [See Personal Greetings.](#)**
- 6 Mailbox Administration - [See Mailbox Administration.](#)**
- # Personal Services - [See Personal Services.](#)**
- \* Return to Main Menu.**

**Voicemail and the Function Soft button:** When accessing and retrieving voicemails from the mailbox, the service options such as **(1) Listening to Messages**, **(2) Record and Send Messages**, and **(3) Review Saved Messages** are available and can be accessed through the dial pad or through the **Function** soft key. When pressing the function soft button the options will be displayed. Scroll to and press the **OK** button to select an option from the **Function Menu**.

## GETTING STARTED

Using your new Samsung Voicemail Subscriber Services is as simple as following a few simple spoken instructions. First time users should read this section as a tutorial. You should start with the following steps:

- Access your Subscriber Services Menu - You already know how to do this.

### From the Subscriber Services Menu:

- Record a Primary/No-Answer Personal Greeting. Dial **[5][1]**.
- Record a Mailbox Greeting. Dial **[5][7]**.
- Change your access code (Password). Dial **#[7][1]**.
- Record your name. Dial **#[7][2]**.
- Enter your directory name. Dial **#[7][3]**.

After you have completed the steps above your Subscriber Services are set up and ready to use.

## LISTEN TO YOUR MESSAGES

If there are new messages in your mailbox your **[VMMMSG]** key will be lit. Call the Samsung Voicemail by pressing this key, and when prompted enter your password. You will then be at the Subscriber Services Menu. Select **[1]** to listen to new messages or **[3]** to listen to saved messages.

Note: After you enter your password, if "Autoplay of New Messages" is enabled and you have new messages the Samsung Voicemail will begin to play them automatically. A subscriber can control this feature. From the Subscriber Services Menu **[6][5]** toggles "Autoplay of New Messages" ON/OFF.

## SUBSCRIBER SERVICES MENU

The following is a list of all the options available in the Subscriber Main Menu.

- 1** LISTENING TO NEW MESSAGES
- 11** GROUP NEW MESSAGES
- 2** RECORD AND SEND A MESSAGE
- 3** LISTENING TO OLD MESSAGES
- 33** GROUP OLD MESSAGES
- 4** ACCESS MANAGER
- 5** PERSONAL GREETINGS
- 6** MAILBOX ADMINISTRATION
- 8** PAUSE / RESUME
- 0** PLAY MENU OPTIONS
- \*** EXIT TO AUTO ATTENDANT
- #** PERSONAL SERVICES

# 1 or 3

## LISTENING TO OLD OR NEW MESSAGES

- 1 Play / replay the message you just heard.
- 11 Play the previous message.
- 2 Save the message you just heard and listen to the next message.
- 3 Delete the message you just heard and listen to the next message.
- 4 Reply to the message.  
This will allow you to leave a message in the mailbox of the sender (if the sender has a mailbox on this system).
- 5 Return the call directly to the telephone number that left the message.  
This will work for internal and external callers, but Caller ID service is needed to use this feature on an outside call.
- 55 Deliver a fax copy.  
This will allow you to receive attached faxmail document(s). Faxmail documents can be delivered to any fax machine of your choice as long as out calling is authorized. You can also have faxmail messages automatically delivered to the fax machine of your choice.
- 6 Forward the message and saves a copy.  
The subscriber can be selected by dialing their mailbox number (nnn), using the directory service (#) or you may also add comments and leave it as a memo to yourself (##).  
The Send and Copy Service (option 6) allows a user to send copies of a message to multiple recipients easily. A different introduction message may be left for each recipient.
- 7 Rewind the message 5 seconds.
- 77 Change playback volume of the recording. **[Not available on the OS 7030, OS 7100, OS 7200-S or OS IP-UMS]**  
There are two levels of volume during playback. Dialing this code will toggle between the two levels.
- 8 Pause or resume during message playback.
- 9 Fast forward the message 5 seconds.
- 99 Change playback speed of the recording. **[Not available on OS 7030, OS 7100, OS 7200-S or OS IP-UMS]**  
There are two levels of speed during playback. Dialing this code will toggle between the two speeds.

- 0 Play options.  
Pressing this key will play all the menu options available to you from this point.
- 00 Hear the time and date, and sender's information of the message you just heard. Sender information is not available on outside calls.
- # Move to the next message. This does not Save or Discard the current message - it is retained as new.
- ## Scan. Plays first 7 seconds of a message then skips to next message. This is similar to the scan button on a radio. It will allow you to find a specific message quickly. To stop scanning press [1].
- \* Cancel and return to previous menu.

# 11 or 33

## GROUP NEW OR OLD MESSAGES

Messages can be grouped as either Reminders, press [3] or Messages from a specific sender, press [9].

Additionally you can press [#] and hear a summary of your mailbox contents:

- a) Number of messages
- b) Number of reminders
- c) Number of urgent messages
- d) Number of messages needing a callback
- e) Number of private messages
- f) Number of fax messages

# 2

## RECORD AND SEND A MESSAGE

This option is used to send a message to another subscriber. The steps are simple:

- a) Enter the recipient's mailbox number, or if this is not known enter [#] to use the system directory.
- b) Record your message at the tone. After recording the message, you will hear the Send Menu with the following functions:
  - 1 Review
  - 2 Continue Recording

- 3 Discard and Re-Record
- 4 Set Message Attributes (Delivery Options)
- 5 Schedule Future Delivery
- 6 Save and Send then Send a Copy to Someone Else
- # Save and Send the Recording

## Setting Message Attributes

If after recording a message you select **[4]** you can set up any combination of the following delivery options:

- 1 Urgent Delivery
- 2 Return Receipt Requested
- 3 Request a Call Back
- 4 Private Delivery
- 5 Reply Required
- \* Exit

## Scheduling Future Delivery

If after recording a message you select **[5]** to schedule future delivery, you will be able to set message attributes and set this message as:

- # Immediate Delivery
- 1 Next Few Hours
- 2 End of Current Business Day (based on your Availability Schedule)
- 3 Beginning of Next Business Day (based on your Availability Schedule)
- 4 A Coming Day of the Week
- 5 Specific Day / Time
- \* Exit

# 4

## ACCESS MANAGER

The Access Manager allows the subscriber to set a number of options for when, where and how, and/or if the Samsung Voicemail contacts you when a caller dials your extension number. All of the options are toggled on/off based on their current status when you access them.

**Note: ALL** Access Manager options **MUST** be individually allowed by the System Administrator for each Subscriber. They are:

### 1 Follow Me

Allows the subscriber to enter an alternate location and set how long the new destination (Designated Location) will be active. This number may be an internal or external number. This is useful if you are frequently traveling or changing the number where you can be reached.

When Follow Me is activated, the transfer will be supervised and confirmed. This means that if the call is not answered or if rejected by the Subscriber at the designated location it will be recalled to the Subscriber's mailbox.

### 3 Call Blocking

When this feature is active, callers will not be transferred to your extension, they will hear your 'blocked' greeting (if recorded) and will go directly to your mailbox if they do not select any or are not offered any other options.

### 4 Call Forwarding

Unlike Follow Me where the subscriber wants to take their calls at an alternate location this feature allows the subscriber to pass control of his calls to another Subscriber. The "Forwarded To" Subscriber will now be in control of the caller and the caller will NOT return to originating Subscriber's Mailbox. If the "Forwarded To" Subscriber does not answer the caller it will now follow whatever the "Forwarded To" Subscriber has set up for their call conditions. The Caller will hear "Forwarding to" "{Subscriber Name}" before actually being forwarded.

### 5 Call Screening

If this is turned on, the caller will be asked their name and the Samsung Voicemail will play this name to you before the transfer, giving you an option to accept or reject the call.

## 6 Find Me

Find Me, when enabled, will attempt to locate the subscriber by calling a list of preprogrammed phone numbers. The stored phone numbers are entered in 'Personal Services' [#][2] (if allowed by the Administrator). The stored telephone number list can contain up to 9 preprogrammed telephone numbers. The Find Me feature only use the first five.

## 7 Night Intercept

This feature is dependent on your weekly availability schedule, which is entered in 'Personal Services' [#][3] (if allowed by the Administrator). When Night Intercept is active the Samsung Voicemail will first ring your extension then play your primary, No Answer greeting during the day (when you are available) and will NOT ring your extension but simply play your Night greeting during the night (when you are not available).

**Note:** This does NOT use the Day and Night schedules of the phone system. It is solely controlled by the Subscriber's Availability Schedule.

## 8 Pause / Resume

### \* Exit from Access Manager

### 0 Play All Options

### # Play Access Coverage

This feature is useful for finding out how you current access settings are set. It will also tell you what greetings will play under each of the call conditions you have setup.

# 5

## PERSONAL GREETINGS

The options available in this menu will be determined by your System Administrator, and not all of them may be available to you. In the simplest systems, only a mailbox greeting will be available, additional greetings may be accessible in more complex systems.

Your Personal Greeting will be played every time someone dials your extension and you do not answer.

You may record up to 9 Personal Greetings, and you may assign any one of them to be active. There are several different 'Call Coverage' conditions to which you may assign any of your 9 greetings. The Call Coverage Conditions are: No-Answer, Busy, and Do Not Disturb (or Forwarded All). This will allow different greetings to play depending on the type of call forward that you have set, or the condition of your telephone.

The Call Coverage conditions that you can assign specific greetings to are selected by the following digits:

### 1 Primary/No Answer Greeting

Used when in your office, away from your desk or during the time period you are scheduled available. If this is the only Personal Greeting you record, it will play for all call coverage conditions.

This option is available only if the Administrator has assigned you the 'Basic Greeting' feature.

Example: "Hi this is John Smith. I'm sorry I am not available to answer your call. If someone else can help you, please enter the extension number now. Or, to leave me a message, press 1."

### 2 Busy Greeting

Played to a caller when you are already talking to someone on your extension or the telephone at your Designated Location.

This option is available only if the Administrator has assigned you the 'Busy Greeting' feature.

Example: "Hi, this is John Smith. I'm on another line right now. If someone else can help you, please enter the extension number now. Or, to leave a message, press 1."

### 3 Call Blocking Greeting

Used while Call Blocking is enabled in your Access Manager or if your phone is forwarded ALL or DND.

This option is available only if the Administrator has assigned you the 'Call Blocking' feature.

Example: "Hi, this is John Smith. Sorry I missed your call, but I'm going to be out of the office for the next few hours. If someone else can help you, please enter the extension number now. Or, to leave me a message, press 1."

### 4 Night Greeting

Used during the time period you are scheduled UNAVAILABLE, usually after business hours during the evening and at night.

This option is available only if the Administrator has assigned you the 'Scheduling' feature.

Example: "Hi, this is John Smith. I've left the office for the evening. If you would like to try someone else, please enter the extension number now. Or, to leave me a message, press 1."



## 5 Call Screening Greeting

Used while Call Screening is enabled, and you REJECT a caller after listening to the caller's record name.

This option is available only if the Administrator has assigned you the 'Call Screening' feature.

Example: "Hi, this is John Smith. I'm sorry, but I am not available to speak with you at this time. If someone else can help you, please enter the extension number now. Or, to leave me a message, press 1."

## 6 Edit Personal Greetings

You may also edit/record each one of the greetings (1-9) at any time.

Select a greeting number to edit and follow the instructions to record your greeting. When you are done recording your greeting, you will be able to listen to the greeting you recorded, save the greeting you recorded and return to the previous menu, record the greeting again, or exit without saving the greeting.

Note: If you record only the greeting assigned to the No-Answer Call Coverage Condition, then that greeting will play to callers for all Call Coverage Conditions (No-Answer, Busy, Blocked, Night, and Rejected Caller). In this case, the salutation part of the greeting should be very general.

## 7 Edit Mailbox Greeting

Used whenever a caller reaches your mailbox or if you have not recorded any of the Call Coverage greetings. The way a caller is transferred to your mailbox greeting directly, is by another subscriber transferring the caller to your mailbox using the VT (VoiceMail Transfer) key.

This option is available only if the Administrator has assigned you the 'Mailbox Greeting Option' feature.

Example: "Hi, this is John Smith. Please leave me a message, I will call you as soon as I can."

Note: This greeting will only play if none of the 5 personal greetings has played to the caller. A common usage for this Greeting is when another Subscriber is talking with a caller and uses the VT key on their phone to transfer the caller directly to your Mailbox.

# 6

## MAILBOX ADMINISTRATION

The Mailbox Administration menu is used to turn on and off your pager notification, message alert options and other message control features.

### 1 Message Alert

When this function is activated, the Samsung Voicemail will call any outside or inside telephone number, after each message is left in your voice mailbox.

To hear your message at the remote location when the Samsung Voicemail calls you, after you pick up the telephone and answer you will be instructed that there is a message and to enter your password. Simply enter your password and you will now be logged in.

#### Setting Up Message Alert:

- From the Subscriber Services Menu press **[6]** for Mailbox Administration.
- Press **[1]** for Message Alert.
- There are 4 options available to you:
  - Press **[1]** to toggle message alert on and off.
  - Press **[2]** to set the schedule when you would like to be notified.
  - Press **[3]** to be notified on urgent messages only.
  - Press **[4]** to set the destination phone number.

### 2 Pager Notification

When this function is activated, the Samsung Voicemail will call your beeper service and notify you after each message is left in your voice mailbox.

- From the Subscriber Services Menu press **[6]** for Mailbox Administration.
- Press **[2]** for pager notification.
- There are 4 options available to you:
  - Press **[1]** to toggle pager notification on and off.
  - Press **[2]** to set the schedule when you would like to be paged.
  - Press **[3]** to be notified on urgent messages only.
  - Press **[4]** to set the pager phone number.

### 3 Undelete

When this function is activated, the Samsung Voicemail will allow you to undelete any messages that you have recently deleted (up to the programmed Daily Maintenance Time, which is set to 3 a.m. by Default the following morning).

- From the Subscriber Services Menu press **[6]** for Mailbox Administration.
- Press **[3]** for Deleted Messages.

Deleted voice mail messages are temporarily stored in memory until 3 a.m. the following day. Select this option to recover ("undelete") previously deleted messages, during this period of time.

### 4 Undelivered Retrieval

When this function is activated, the Samsung Voicemail will allow you to recall any messages you have sent that have NOT yet been picked up by the recipient.

- From the Subscriber Services Menu press **[6]** for Mailbox Administration.
- Press **[4]** for Undelivered Messages.

This useful feature will allow you to cancel any messages that have NOT yet been picked up by the recipient.

### 5 Auto Play New Messages

If this option is enabled, after you enter your password correctly any new messages will immediately begin to play. To enable (or if already enabled toggle and disable) this feature:

- From the Subscriber Services Menu press **[6]** for Mailbox Administration.
- Press **[5]** to Set Auto Play of New Messages.

### 6 Auto Play Message Information

If this option is enabled, the date, time and sender's name will be played automatically before each message. If this is disabled, the information must be requested manually by pressing '00'. To enable (or if already enabled toggle and disable) this feature:

- From the Subscriber Services Menu press **[6]** for Mailbox Administration.
- Press **[6]** to Set Auto Play of Message Information.

## 9

## MESSAGE BROADCAST

This option will only be available if it has been allowed by the System Administrator.

### Broadcast to All Mailboxes

If you have been designated as a Subscriber Administrator, you may send a message to ALL mailboxes in the system.

- From the Subscriber Services Menu press **[6]** for Mailbox Administration.
- Press **[9]** for Broadcast Messages.

This option will only be available if your mailbox has been assigned Subscriber Administration privileges.

## #

## PERSONAL SERVICES

The Personal Administration Menu is used to set your password and record your name. Many of these features must be allowed by the System Administrator.

### 1 Workload Management

Allows you to access to all reminders, both Active and Pending. If authorized you can group your reminders as Commitments, Follow-Ups or Tasks for better organization. The system will flag each reminder as Active or Pending (pending means scheduled for future delivery).

### 2 Stored Numbers

Allows you to enter up to 9 stored phone numbers. The first five of these are used in the 'Find Me' feature, but any of them (1-9) can be easily dialed using only one digit followed by the pound key, to be used by many other features from within your subscriber space. (ie: "Follow Me," "Message Alert," "Pager Alert," and "Direct Call").

### 3 Schedule Availability

Allows you to enter a weekly availability schedule for use with Night Personal Greeting and the Auto Night Intercept feature. Follow the spoken directions

to enter the days of the week and times you are generally available to talk to your callers. All other times you will be considered unavailable.

## 5 Place a Direct Call

Allows you to place a direct call out of the Samsung Voicemail from anywhere. You may either dial the number or dial a single digit 1-5 that corresponds to a stored number ([See Personal Services, 2 - Stored Numbers](#)). This feature must be authorized by the System Administrator and can be limited or opened to internal, local, and long distance calls.

## 7 Personal Administration

This area is used during the initial set up of your Subscriber Settings ([see next section](#)).

# PERSONAL ADMINISTRATION SETTINGS

This menu allows you to make changes to basic setup settings, that are rarely changed. Use these when you initially set up your personal Subscriber settings. You probably will not need to change them after that.

### 1 Setting your Password

- From the Subscriber Services Menu press **[#][7][1]**.
- The current password will be played and you will have the chance to change it.

### 2 Recording your Name

Use this option to record your name. Your recorded name is played in several different situations. It is important to record your name for proper operation of the Samsung Voicemail system.

- From the Subscriber Services Menu press **[#][7][2]**.
- The current name will be played and you will have the chance to change it.

Note: It is possible that if you do not record your name and/or enter your Directory Name (described below), you will not be included in the Dial by Name Directory.

### 3 Entering your Directory Name

Use this option to enter your Directory Name. Your Directory Name is used by callers to find you if they do not know your extension number.

- From the Subscriber Services Menu press **[#][7][3]**.

- The current Directory Name will be played as a string of digits that are equal to your name spelled out on your telephone keypad. Follow the instructions to enter a new name. You will be prompted to enter your last name and then your first name.

This must be done in order for the directory feature to work correctly.

Note: It is possible that if you do not record your name (described above) and/or enter your Directory Name, you will not be included in the Dial by Name Directory.

## 4 Extended Prompting

Use this option to drastically reduce the number of prompts played in the subscriber interface (mailbox prompts). Change this setting only if you are very familiar with the user operation of the SVMi E-Series.

Note: Remember if you know what digits to press, you can enter them at any time you do not have to wait to be prompted. This feature can be toggled on/off at anytime. Also if it is off you will be prompted within each subscriber menu to press zero for more options. This enables you to still be able to find out what to do if you were to get lost and extended prompting was disabled.

# KEYSET USER FEATURES

The following options are available if you have a display keyset. They require setup by the System Administrator.

## Message Waiting Lights

When new messages are left in your mailbox, the voice mail message light on your keyset will flash. Press this flashing key **[VMMMSG]** and follow the prompts to retrieve messages. This key may be pressed at any time to log into your Subscriber Main Menu.

## Answer Machine Emulation

If you have an Answer Machine Emulation key programmed on your keyset, you can use it to monitor calls going to your voice mail, and optionally answer them. The operation of this feature is similar to screening a call on a home answering machine.

Your keyset must be set to forward on no answer to voice mail. After ringing your station the caller will be connected to your voice mail and hear your personal greeting before leaving a message. During this time you will be monitoring the connection between the caller and your voice mail box. At this time you will only be monitoring the call, you can not talk to the other party until you answer. You may pick up the call at any time or ignore it.

To activate this feature press the **AME** button. The associated indicator will be lit steady. Press again to turn off. If this key is pressed while a station is ringing (during forward no answer), the feature will be turned on for the current call only.

While the caller is leaving a message or ringing you may:

- Press **[#]** to immediately put the caller in your voice mailbox and monitor it.
- Press **[\*]** to immediately disconnect your station. The caller continues to leave a message normally.
- Pick up the handset and monitor privately.
- Press **ANS / RLS** to answer the call (using the handset or speaker).

## AME Password

If your keyset has **AME Password** (MMC 110) set to **Yes**, you must enter your station password to listen to messages being left. This will prevent unauthorized people from listening to messages being left for you.

If the password option is turned on, while a message is being left, press the flashing **AME** indicator and enter your station password (not your SVMi E-Series password). You will then hear the message being left.

## Call Record

If you have a call record button assigned to your phone, you may press it at any time, to record the conversation in progress. If you have a display keyset, you will also have the soft key options to pause and time the message.

## SHORTCUTS

### Calling

Calling a station that is busy or does not answer you can press **[#]** to immediately send the call to the called parties mailbox.

### Call Divert to Voicemail

While receiving an incoming (ringing) call, dial **[\*]** to immediately send the caller to your personal voicemail box. This will override the call forward no answer setting.

### Direct Messaging

**[#] + DSS** To make it easy to leave messages for others in your office without having to dial their extension number first, keyset users may simply dial **[#]** plus a mailbox (extension) number and leave a message directly. If you dial a busy extension press **[#]** to connect directly with the mailbox.

### Self Memo (Reminder)

Pressing **[##]** will leave a message in your own mailbox. This is useful to remind yourself of things to do now or in the future. Messages can be sent with future delivery so you can have the system call you when items become due.

## INTERACTIVE DISPLAYS

Display keyset users have the added advantage of using the soft keys and displays to play, save, delete, reply, call, forward, rewind, pause, fast forward, change the volume, get message information, or help.

### Viewing Mailbox Contents

If you have new messages, in addition to the Telephone Status Indicator (TSI) you will be able to use the keyset displays and soft keys to communicate with the SVMi E-Series.

## E-MAIL GATEWAY (EMG)

The E-Mail Gateway feature integrates your voice mail box with your email client. No matter what email client software you are using or where you use it, you can send voice mail messages and fax mail messages to your E-Mail inbox.

There are two parts to the E-Mail Gateway; E-Message Delivery and E-Message Notification.

1. **E-MESSAGE DELIVERY:** Voice mail messages (.wav) and/or fax mail messages (.tiff) are "delivered" to your Inbox with the appropriate attached file.
2. **E-MESSAGE NOTIFICATION:** You will receive an e-mail, with NO attachments, notifying you that you have a voice and/or fax mail message in your Voice Mail Box.
  - As a subscriber you can use either E-Message Delivery and/or E-Message Notification.
  - As a subscriber you can have multiple e-mail addresses. (a maximum of 5 valid email addresses).
  - E-Message Notification can be set to one e-mail address while E-Message Delivery is set to different e-mail address.

## Functionality

- With either type of EMG, when Caller ID (CID) is provided, the callers telephone number will appear in the subject field of the email along with the date and time stamp of when the voice message was originally recorded in your Voice Mail Box.
- If the caller is also a subscriber on the system and the E-Mail Gateway is set up with a valid "Reply To" address, the Subscriber's name will also appear in the "From" field. Otherwise, the "From" field will display the name of the Samsung voice mail system (SVMi-8E, SVMi-16E, or SVMi-20E) sending the message.
- Client will use their PC's Multi-Media kit (equipped with either speakers and/or a headset) to listen to messages delivered to their e-mail Inbox.

**IMPORTANT NOTE:** If the PC/Laptop/PDA/Smart Phone/etc... is not equipped with hardware and software capable of playing a '.WAV' file then the E-Mail Gateway will not work for them until they add some method to listen to '.WAV' files delivered to their Inbox.

The same applies to Fax Mail messages, if the device the subscriber is using does not support the viewing of '.TIFF' files, then the E-Mail Gateway for Fax Mail will not work for them until they add some method to view .tiff files delivered to their inbox.

- No Synchronization of messages is performed between the Voice Mail Box and the E-mail Inbox.
  - Messages listened to, forwarded, deleted, and/or saved within an e-mail inbox will NOT effect the status of that same new message in the Voice Mail or the MWI (Message Waiting Indicator) associated with that message on the phone.
  - Also messages listened to in the Voice Mail, from a phone, will not change the Unread/Read status of the same message in an e-mail inbox.

- However, the Voice Mail Administrator can adjust parameters per subscriber or group of subscribers that decide how, when, or if to delete the original voice message after it is sent to the E-Mail Server.
- When full synchronization of messages between Voicemail Box and E-mail Inbox is required, ask your Samsung representative about the OfficeServ IP-UMS. This is an Internet Protocol based fully synchronized Unified Messaging System.

## Benefits

- Store and Archive Voice and Fax Mail Messages in visible folders.
- Voice and Fax Mail Messages can now easily be dragged and dropped into folders the same way e-mail messages are organized and saved.
- Voice and Fax Mail Messages are now essentially the same as any other e-mail message.
- Backups and Message Archives can be made when they are made for all other types of e-mail messages.
- Add text notes and comments to use for reference later.
- Some (if not all) e-mail clients will allow you to edit the body of the e-mail to add comments.
- Some will allow you to edit the subject field to help you find a particular message quickly in a large archive of messages.
- Call Back Numbers and Date & Time Stamp are easily displayed in the Subject field.
- Easily forward Voice messages received, to others even if they are not a Voice Mail Subscriber on your system.
- No EMG System or Client Software to load on your Local PC or Network Servers.

Therefore compatible with most:

- E-Mail providers and E-Mail Clients
- PCs, Laptops, PDA, and/or Smartphones

**NOTE:** If you are not sure you have this functionality on your system and you would like to use it, please contact your on Site system administrator to see if it is available.

## PERSONAL SPEED DIAL NUMBERS

CODE	NAME	TELEPHONE NUMBER
00	_____	_____
01	_____	_____
02	_____	_____
03	_____	_____
04	_____	_____
05	_____	_____
06	_____	_____
07	_____	_____
08	_____	_____
09	_____	_____
10	_____	_____
11	_____	_____
12	_____	_____
13	_____	_____
14	_____	_____
15	_____	_____
16	_____	_____
17	_____	_____
18	_____	_____
19	_____	_____
20	_____	_____
21	_____	_____
22	_____	_____
23	_____	_____
24	_____	_____

## PERSONAL SPEED DIAL NUMBERS

CODE	NAME	TELEPHONE NUMBER
25	_____	_____
26	_____	_____
27	_____	_____
28	_____	_____
29	_____	_____
30	_____	_____
31	_____	_____
32	_____	_____
33	_____	_____
34	_____	_____
35	_____	_____
36	_____	_____
37	_____	_____
38	_____	_____
39	_____	_____
40	_____	_____
41	_____	_____
42	_____	_____
43	_____	_____
44	_____	_____
45	_____	_____
46	_____	_____
47	_____	_____
48	_____	_____
49	_____	_____

## FEATURES AND SPECIFICATIONS

### LINE GROUPS

9 Local/LCR  
 800 \_\_\_\_\_  
 801 \_\_\_\_\_  
 802 \_\_\_\_\_

### STATION GROUPS

501 \_\_\_\_\_  
 502 \_\_\_\_\_  
 503 \_\_\_\_\_  
 504 \_\_\_\_\_

### PAGING ZONES - DIAL 55 PLUS

0 \_\_\_\_\_  
 1 \_\_\_\_\_  
 2 \_\_\_\_\_  
 3 \_\_\_\_\_  
 4 \_\_\_\_\_  
 5 \_\_\_\_\_  
 6 \_\_\_\_\_  
 7 \_\_\_\_\_  
 8 \_\_\_\_\_  
 9 All External Zones  
 \*All External Zones and Internal Zone 0

### PROGRAMMED MESSAGES

01 In A Meeting  
 02 Out On a Call  
 03 Out To Lunch  
 04 Leave A Message  
 05 Page Me  
 06 Out Of Town  
 07 In Tomorrow  
 08 Return Afternoon  
 09 On Vacation  
 10 Gone Home  
 11 \_\_\_\_\_  
 12 \_\_\_\_\_  
 13 \_\_\_\_\_  
 14 \_\_\_\_\_  
 15 \_\_\_\_\_  
 16 \_\_\_\_\_  
 17 \_\_\_\_\_  
 18 \_\_\_\_\_  
 19 \_\_\_\_\_  
 20 \_\_\_\_\_

### FEATURE ACCESS CODES

10 + xxx	Pick Up A Parked Call
12 + xxx	Pick Up A Held Call
13	Door Lock Release
16 + xxx	Speed Dialing
17	Save And Redial Number
18	New Call (Recall)
19	Last Number Redial
400	Cancel Do Not Disturb
401	Set Do Not Disturb
42 + xxx	Cancel Message You Left
43	Return Message
44	Callback
45	Busy Station Camp-On
46	Conference
47	Account Code
48 + xx	Cancel Programmed MSG
49	Send Flash To C.O. or PBX
56	Meet Me Answer
600	Cancel All Call Forward
601 + xxx	Set Forward All Calls
602 + xxx	Set Forward Busy
603 + xxx	Set Forward No Answer
604 + xxx	Set Fwd Busy/No Answer
605 + xxx	Set Forward on DND
606 + xxx	Set Forward Follow Me
65 + xxx	Pick Up Ringing Extension
66 + xx	Pick Up Group
67	Universal Answer
*	Authorization Code



# OfficeServ™

## SMT-i3105



USER GUIDE



# OfficeServ™ SMT-i3105

## Keyset User Guide

*For OfficeServ™ 7000 Series Systems*



# TABLE OF CONTENTS

<b>ABOUT THIS BOOK</b> .....	1
<b>SECTION 1. CAUTION AND PREPARATION</b> .....	2
<b>CAUTION</b> .....	3
<b>PREPARATION</b> .....	4
Check the Contents of the Box .....	4
Phone Installation .....	4-5
<b>SECTION 2. PHONE FUNCTIONS</b> .....	6
<b>SMT-i3105 LAYOUT</b> .....	7
Names and Functions .....	7
<b>KEY FUNCTIONS</b> .....	9
Telephone Status Indicator .....	9
Screen Structure .....	9
Text Input Method .....	10
Description of Icons .....	11
Navigating the Display .....	11
<b>SMT-i3105 SETUP</b> .....	12
Initializing the SMT-i3105 .....	12
Setup Mode .....	12
Easy Install Wizard .....	13
Selecting the Static IP Option .....	13
Setting Up Hot Desking (Idle Login) .....	13
Configuration Menu Structure.....	14
<b>SECTION 3. FREQUENTLY USED</b>	
<b>FEATURE OPERATION</b> .....	15
<b>LOGGING IN &amp; OUT</b> .....	16
<b>PLACING CALLS</b> .....	16
<b>ANSWERING CALLS</b> .....	17
<b>PLACING A CALL ON HOLD</b> .....	18
<b>TRANSFERRING CALLS</b> .....	18
<b>TRANSFERRING WITH CAMP-ON</b> .....	18
<b>CALL WAITING</b> .....	19

Copyright 2010 Samsung Telecommunications America.

All rights reserved. No part of this manual may be reproduced in any form or by any means—graphic, electronic or mechanical, including recording, taping, photocopying or information retrieval systems—without express written permission of the publisher of this material.

Samsung Telecommunications America reserves the right without prior notice to revise information in this guide for any reason. Samsung Telecommunications America also reserves the right without prior notice to make changes in design or components of equipment as engineering and manufacturing may warrant. Samsung Telecommunications America disclaims all liabilities for damages arising from the erroneous interpretation or use of information presented in this guide.

<b>CONFERENCE CALLS</b>	19
<b>FORWARDING CALLS</b>	19
<b>OTHER FEATURES AND FUNCTIONS</b>	20-23
<b>SECTION 4. PHONE FEATURES</b>	24
<b>BASIC MENUS</b>	25
Soft Button Structure	26
Menu Soft Button	26-32
Func. Soft Button	32
AOM Soft Button	32
<b>SECTION 5. OFFICESERV 7000 SYSTEM FEATURES</b>	33
<b>OUTSIDE CALLS</b>	34
Making Calls from AOM	34
Universal Answer	34
Recall Dial Tone	34
Sending a Flash	34
Busy Line Queuing with Callback	34
Busy Station Callback	35
Canceling Callback	35
Busy Station Camp-On	35-36
<b>INTERCOM CALLS</b>	37
Voice Announce Mode	37
Auto Answer Mode	37
Calling your System Operator	37
<b>CALL PROCESSING</b>	38
System Hold	38
Exclusive Hold	38
Remote Hold	38
Hold Recall	39
Consultation Hold	39
Retrieving Calls Held at Another Station	39
Call Transfer	40
Transfer with Camp-On	40
Transfer to Voice Mail	41
Call Waiting	41
Call Forward Options	41
Station Call Pickup	42
Group Call Pickup	43
My Group Pickup	43
Privacy Release	43

<b>DIALING FEATURES</b>	44
Speed Dialing	44
Programming Personal Speed Dial Numbers	44
Directory Dialing	45
Last Number Redial	46
Save Number with Redial	46
Automatic Redial/Retry	46
Pulse to Tone Changeover	46
<b>PAGING AND MESSAGING</b>	47
Making and Internal Page	47
Making an External Page	47
All Page	47
Meet Me Page	48
Call Park and Page	48
Messages—Set and Cancel	49-50
Returning Messages	50
Programmed Messages	50
<b>CONVENIENCE FEATURES</b>	51
Logging In and Out	51
Do Not Disturb	51
One Time DND	51
Mute	52
Background Music	52
Established Call Pick-Up	52
Door Phone Calls	52-53
Group Listening	53
Account Codes	53
Manual Signalling	54
Off-Hook Voice Announce	54
OHVA Block	55
OHVA Reject	55
In Group/Out of Group	55
<b>CUSTOMIZING YOUR KEYSSET</b>	56
AME Password	56
Auto Camp-On	56
Select Ring Tone	56
Change Your Passcode	56
Set Answer Mode (Intercom)	57
Set Answer Mode (CO)	57
Automatic Hold	57
Hot Keypad	57
Key Confirmation Tone	58
Rejoining a Page	58

Ring Preference .....	58
Display Speed Dial Name .....	58
Caller ID Review All .....	59
Secure OHVA .....	59
Configure Mobile Extensions (MOBEX) .....	59
<b>DISPLAY FEATURES .....</b>	<b>61</b>
Directory Information .....	61
Display Number Dialed .....	61
Call Duration Timer .....	61
Auto Timer .....	61
Timer Function .....	62
Viewing Station Message Indications .....	62
Personal Speed Dial Names .....	62
Station Names .....	62
Managing Programmable Key Assignments .....	63
Backspace with LCR .....	63
<b>CALLER ID .....</b>	<b>64</b>
Selecting Your Caller ID Display .....	64
Viewing the Next Caller ID Call .....	65
Inquire Caller ID Park/Hold Info .....	65
<b>FEATURE ACCESS CODES .....</b>	<b>66</b>
<b>SECTION 6. APPLICATIONS .....</b>	<b>67</b>
<b>SAMSUNG VOICEMAIL .....</b>	<b>68</b>
Accessing Your Mailbox .....	69
SVMi E-Series Subscriber Services Menu Diagram .....	70–71
Getting Started .....	72
Listen to your Messages .....	72
Subscriber Services Menu .....	72
Listening to Old or New Messages .....	73
Group New or Old Messages .....	74
Record and Send a Message .....	74
Access Manager .....	76
Personal Greetings .....	77
Mailbox Administration .....	80
Message Broadcast .....	82
Personal Services .....	82
Personal Administration Settings .....	83
Keypad User Features .....	84
Shortcuts .....	86
Interactive Displays .....	86
E-Mail Gateway (EMG) .....	86–88
<b>PERSONAL SPEED DIAL NUMBERS .....</b>	<b>89–90</b>

## ABOUT THIS BOOK

The new Samsung Multimedia Telephone SMT-i3105 keyset is part of the OfficeServ 7000 Series.

The SMT-i3105 keyset represents a new concept of Internet phone, in that it uses an IP address to Send/Receive voice and data. For voice communications, the SMT-i3105 uses the data network line already in place in most offices and increasing number of homes.

This guide contains 6 sections: Section 1. Caution and Preparation, Section 2. Phone Functions, Section 3. Frequently Used Feature Operation, Section 4. Phone Features, Section 5. OfficeServ 7000 System Features and Section 6. Applications. Please take the time to study this guide and to become familiar with the operation of your keyset. Keep this guide handy, as you may need to look up instructions for infrequently used features.

This book is written based on factory default settings, for the feature access codes. Sometimes, due to programming requirements, these codes may be changed. If you find that a feature code does not work as described in this book, please contact your installation and service company to determine the correct code.

## CAUTION

# SECTION 1. CAUTION AND PREPARATION

- Read the installation instructions before connecting the system to its power source.
- If there is dirt or moisture on the pin contact surface of a power plug, pull out the plug and wipe it away with a cloth. If dirt or moisture remains on the product even after wiping, contact the service center.
- For the power connection port of the phone, use the supplied power adapter. (The power adapter is supplied separately.) Use of a power adapter that does not meet the specifications may cause the product to become damaged, to overheat, or to explode.
- Do not place the phone in a location with a lot of dust, in a location that is subject to severe changes in temperature, or near a heating device (cigarette heat, heater, etc.)
- Do not use or store flammable spray or materials near the phone.
- Do not place vases, flowerpots, cups, or a container of cosmetics or drugs near the phone.
- Installation of equipment must not route interconnecting cables or external power supply sources outdoors.
- The LAN cable to the network should be connected to the LAN port of a phone, NOT to the PC connection port.
- Use a soft and dry cloth when cleaning the phone. Do not spray water directly onto the product; and do not use chemicals such as wax, benzene, alcohol, thinner, mosquito killer, perfume spray, lubricant, detergent, etc.

# PREPARATION

## CHECK THE CONTENTS OF THE BOX

Check if the product package box includes all the components as follows:

- Phone body including a base
- Handset and Handset Cord
- Patch cable

**NOTE:** Power transformer sold separately. If any of these items are missing or damaged, please contact your dealer.

## PHONE INSTALLATION

### Connecting the Phone Body

- 1 Remove the base of the phone by pressing the **[Push]** mark on the top of the base.

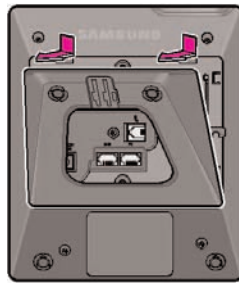

- 2 Connect a handset to the handset port of the phone.

Connect RJ45 cable through middle hole of stand to LAN and the other end of cable to the phone system (data network). If PoE data switch is used, it will power up the phone.

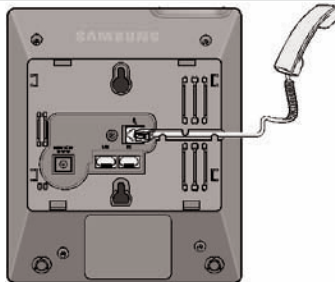

- 3 **OPTIONAL:** Connect the cable through the middle hole of the base to the PC, as shown in the figure. When connecting to PC, connect one end of the cable to the PC port of the phone, and the other end of the cable to the LAN port of the PC.

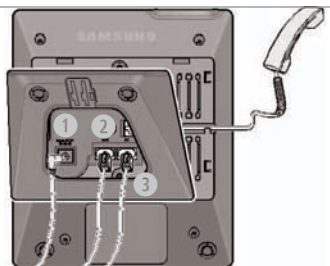

① AC Power ② LAN to Phone System ③ Phone to PC-10/100 Base T Switch

Connect the LAN cable (connected through the middle hole of the base to a network) to the LAN port of the phone, as shown in the figure.

When power is supplied from the LAN port (PoE) (802.3af), the phone is powered via LAN connection.

If PoE is not supported, connect the power adapter to the **power (-DV 5V) port** of the phone by running the cable through the middle hole of the base as shown in the figure below. If the connected power adapter is plugged into an outlet (120AC), the phone is booted. (The power adapter is supplied separately.)

- 4 Fix the base to the phone body by fitting the bottom groove and then securing the top side.

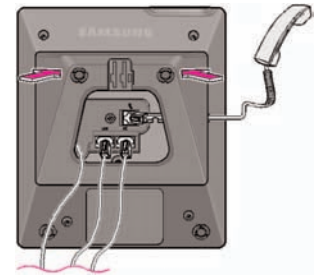

- 5 Secure the cable along the cable guideline as shown in the figure. For the cable of power adaptor, give some slack before securing the cable to the guideline to prevent easy disconnect.

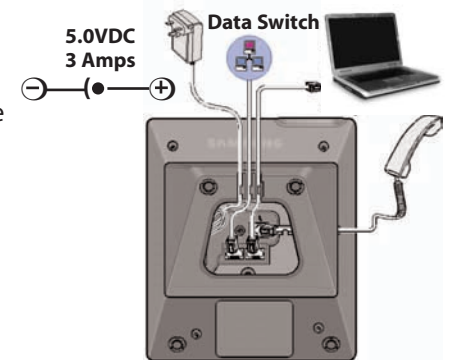

## CAUTION

The input power of the SMT-i3105 needs 5.0vDC and 3000mA. The SMT-i3105 phone needs to be powered by using Samsung's SMT-A53PA power adapter. Failure to use the appropriate power supply will cause permanent damage to the phone and will void Samsung's warranty.

# SMT-i3105 LAYOUT

## SECTION 2. PHONE FUNCTIONS

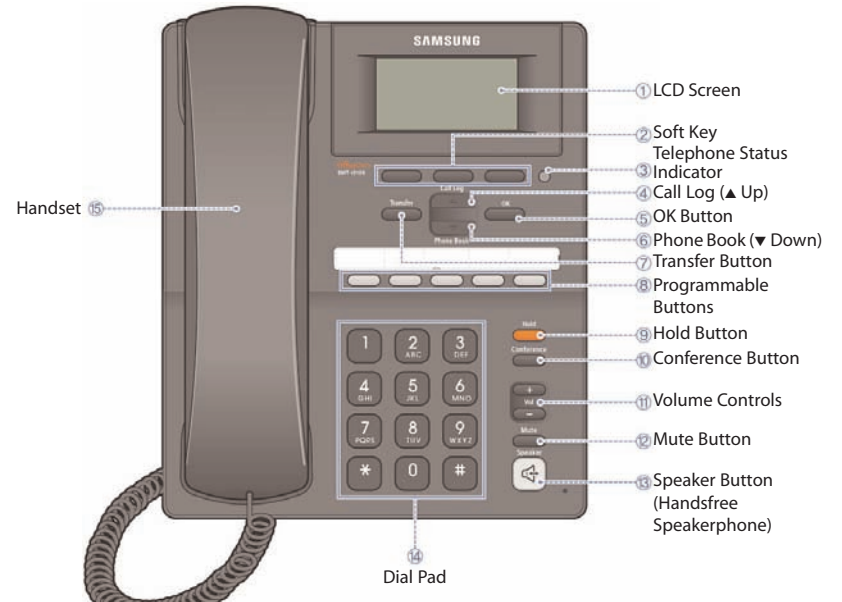

**NOTE:** The words “key” and “button” are interchangeable.

## NAMES AND FUNCTIONS

Button	Function
① LCD Screen	A display showing the phone's status (busy, ringing, receiving an internal message, etc.), time and date, extension number, name.
② Soft Button	Used to select the desired function from the soft menus displayed at the bottom of the LCD screen, such as <b>Back</b> , <b>End</b> , and <b>Save</b> .
③ Telephone Status Indicator	The blinking pattern differs depending on the phone status. Red status for Station Message, Voicemail, and DND, and green status for Incoming CO Call.
④ Call Log Button (▲ Up)	Used to view the entire call history. Used to move upward on various list screens.
⑤ OK Button	Used to make a selection or to save an entry.
⑥ Phone Book Button (▼ Down)	Used to search for a phone number saved in the phone, or to register a new number. Pressing this button shows the main screen of the phone book. Used to move downward on various list screens.

Button	Function
⑦ Transfer Button	Used to enable the call transfer function.
⑧ Programmable Button	Used to set up one touch feature button on the phone.
⑨ Hold Button	Used to place a call on hold.
⑩ Conference Button	Used for conference calls.
⑪ Volume Button [+] [-]	Used to control the volume settings.
⑫ Mute Button	Used to silence the transmit voice to the remote party.
⑬ Hold Button	Used to place a call on hold.
⑭ Speaker Button	Used to enable/disable the use of a speaker phone.
⑮ Dial Pad	Used to dial the phone number.
⑯ Handset	Used for two-way voice conversation.

## KEY FUNCTIONS

**NETWORK:** The SMT-i3105 uses VoIP communication through an already-installed public or private data network.

**LCD SCREEN:** Various functions are displayed on the LCD screen, so you can use them conveniently by using the scroll buttons **Call Log** (▲ Up) or **Phone Book** (▼ Down) on the phone.

**SHORT MESSAGE SERVICE (SMS):** You can exchange text messages internally only using this function. This function is available only on internal IP stations.

## TELEPHONE STATUS INDICATOR

The indicators are turned on or off depending on the status of relevant functions.

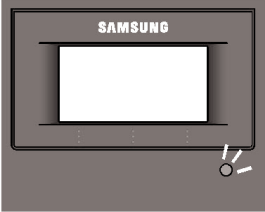
Screen	Status	LED Indicator
	When station is busy	Red colored indicator is constant.
	When station is receiving an incoming call	Green colored indicator flashes.
	When there is a message	Red indicator (slow flash).
	During "Do Not Disturb"	Red indicator (fast flash).
	Hold Recall	Amber colored indicator flashes.

## SCREEN STRUCTURE

The screen consists of three areas.



Area	Description
Icon Area	Displays various icons ( <a href="#">see icon descriptions on page 11</a> ).
Text Area	Displays date, time, extension number, name, message, phone number, etc.
Soft Menu Area	Displays the functions allocated to the 3 soft buttons. Service menus are provided depending on the state of the phone. A user can use the service or feature menus by pressing the <b>Menu</b> or <b>Func.</b> soft button, or the <b>AOM</b> for more soft keys (99).

## TEXT INPUT METHOD

Using the dial and direction buttons on the phone, you can enter and modify the English characters, numeric and special characters.

Whenever you press the dial button [\*] on a text input screen, the input mode is advanced in sequence (on keypad).

### Text Input Example

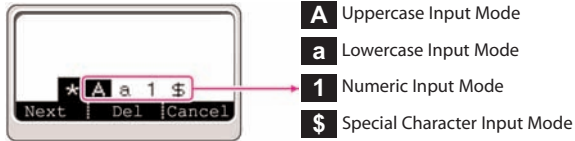

- Use the dial buttons to type English text and numbers; and use the **Direction Arrows** <- : -> in the soft menu screen to move the cursor left and right and **OK** buttons to complete input. When removing the typed characters, select the **Del** soft button or hold down to delete the entire entry.

**Alpha Characters Input:** Select this mode (uppercase/lowercase) by pressing the [\*] button on keypad, and type text by repeated pressing the dial buttons, characters will auto advance after a time limit.

**Number Input:** Select this mode by pressing the [\*] button on keypad, move the cursor highlighted to **1**, then use the keypad to enter digits.

**Special Character Input:** Select this mode by pressing the [\*] button on keypad (advance to \$); select a desired character by using the **Direction Arrows** <- : -> soft button; and press the **OK** button to enter it.

### Keypad Character Entry

Count	1	2	3	4
Dial *	A (Uppercase)	a (Lowercase)	1 (Numbers)	\$ (Special Characters)
Dial #	Not Used			
Dial 0	Not Used			
Dial 1	Not Used			
Dial 2	A	B	C	
Dial 3	D	E	F	
Dial 4	G	H	I	
Dial 5	J	K	L	
Dial 6	M	N	O	
Dial 7	P	Q	R	S
Dial 8	T	U	V	
Dial 9	W	X	Y	Z

## DESCRIPTION OF ICONS

The following icons are displayed on the screen.

Icon	Description
	Shows that 'Call Forward' is enabled.
	Shows that 'Do Not Disturb' is enabled.
	Shows that 'Mute' function is enabled. When the call ends to become a standby status or this function is disabled, this icon disappears.
	Shows that the call is <b>hold</b> state. When call is reconnect or disconnected, this icon disappears.
	Appears when there are unread <b>Short messages</b> in the message inbox. Once they are read, it disappears.
	Shows that a LAN cable is <b>connected</b> to the <b>PC port</b> .
	Shows that a <b>LAN cable</b> is to the LAN port but that the system is <b>not connected</b> .
	Shows that a <b>LAN cable</b> is <b>connected</b> to the LAN port and that the system is connected normally.
	<b>Outgoing</b> call icon.
	<b>Incoming</b> call icon.
	<b>Missed</b> call icon.

## NAVIGATING THE DISPLAY

When programming within various menu options, information can be entered via the dial pad keys using [0]-[9] and [\*] dial keys. The button used for editing and their features are summarized below.

BUTTONS	FEATURES
<b>Left and Right Soft Buttons</b> 	To move the cursor (underlined area) or to erase/write what is entered.
<b>Hold</b>	To clear/delete an entire field such as station name.
<b>Transfer</b>	To write the changes and exit programming.
<b>Volume Button Up (+) Down(-)</b>	To adjust settings (tones), sounds, contrast, etc.
<b>OK</b>	To enter or save a selection.
<b>Call Log (▲ Up)</b>	To move cursor up.
<b>Phone Book (▼ Down)</b>	To move cursor down.



# SMT-i3105 SETUP

## INITIALIZING THE SMT-i3105

Initially the SMT-i3105 IP keyset will need to be setup to operate within the users network. The Setup Menu is also used to make changes to the keyset, in the event that the system information should change. The option chosen will be highlighted.

The station numbers will be automatically created by the OfficeServ 7000 Series systems once the necessary information has been entered into the IP keyset.

Enter ID and password of the server, as described below to register the phone. See your system administrator for specific Network and Server addresses. The addresses necessary to set up the SMT-i3105 are:

- IP Address of Station
- Subnet Mask
- Network Gateway Address
- IP Address of System's main processor
- User ID
- Password

## SETUP MODE

To get to the **SETUP MODE** unplug the power cord from the SMT-i3105. Press and hold the \* button while you plug power back into the phone. Release the \* button when you see Samsung in the display. If you have a PoE (Power over Ethernet) connection, the same procedure can be done by unplugging and plugging the Ethernet cable into the phone while pressing and holding the \* button.

When the phone reboot is complete, the **Language Menu** will display. Press the **OK** soft button to advance to the **Configuration Menu**.

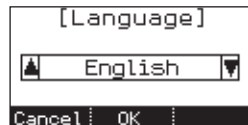

Once the **Configuration Menu** is displayed, you can move to each menu in the Setup by using the **Call Log** (▲ Up) or **Phone Book** (▼ Down) buttons and **[1]-[8]** dial buttons of the SMT-i3105 IP phone. [To learn how to navigate the menus refer to the previous section.](#)

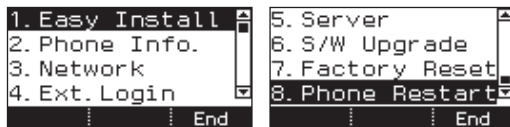

## EASY INSTALL WIZARD

By selecting this option, the System Easy Wizard can guide you through setting up your network parameters. If you want to set up these parameters individually, follow the instructions below.

- From the idle phone press **Menu**, scroll to **Settings**, and press **OK** button. Scroll to **Phone Info** and press **OK** button. From the keypad, enter the administrator's password (please contact your phone system administrator). Press the **OK** button. Scroll to **Easy Install** and press **OK** button.

## SELECTING THE STATIC IP OPTION

- When the Static IP option is selected, the user enters the **Static IP Address** for the phone (eg. 192.168.9.193) then press the **OK** button or the **Next** soft button.
- Enter the **Subnet Mask** (eg. 255.255.255.0); press **OK** button or the **Next** soft button.
- Enter **Gateway Address** (eg. 192.168.9.1), press **OK** button.  
**NOTE:** Press the \* key on the dial pad to enter the "." in the IP address.
- Enter the **System IP address** (eg. 192.168.9.200), press **OK** button.
- Enter **System ID XXXX** (eg. 3201), then press **OK** button.
- Enter **Password XXXX** (eg. 1234) then press **OK** button.

Wait a second for the phone to reboot. The phone should register and authenticate itself to the phone system. Test SMT-i3105 for proper operation.

## SETTING UP HOT DESKING [IDLE LOGIN]

Hot Desking allows you to log in and out of your SMT-i3105 IP keyset without rebooting. [See Setup Mode on how to access the Configuration Menu.](#)

- Press the **Menu** soft button, scroll to **Settings** then press **OK** button.
- Scroll to **Phone Info** and press **OK** button.
- Enter the administrator's password (please contact your phone system administrator).
- Scroll to **Ext. Login** then press **OK** button.
- Choose the **ON** option and press **OK** button. (Note: **ON** to allow, **OFF** to deny hot desking).
- Press the **End** soft button to complete the setup.
- When the phone restarts, enter the **ID** (eg; extension 2809) and **password**.
- Press the **Save** soft button to complete the login.

# CONFIGURATION MENU STRUCTURE

The **Configuration Menu** options are as follows:

## 1. EASY INSTALL

This option will guide you through setting up all required parameters for connecting the SMT keyset to your system.

## 2. PHONE INFO

1. Version Info: Provides boot rom, software, DSP, and hardware version information and date.
2. Network Info: Displays network mode, IP address of phone, network (DNS1, DNS2), Gateway Information, Subnet Mask, MAC Address, LAN (HUB), LAN (PC), PC Client, and Registered State.
3. MAC Address

## 3. NETWORK

Displays Static IP, Dynamic IP, PPPoE, NAT, 802.1x, VLAN (LAN), and VLAN (PC). Set to **Use** or **Not Use**.

## 4. EXT. LOGIN

Allows the user to choose the option of permitting the phone either login/logout from idle mode or only register to the server on power up. Once the phone is placed into Extension Login mode, a display will show up to allow you to enter any valid User ID and password. This function is also referred to as hot desking (idle login). Set to **Use** or **Not Use**. Default password is 1234.

## 5. SERVER

1. Primary System: The main processor's IP address.
2. System 1~3: Up to 4 server IPs can be set.

## 6. S/W UPGRADE

1. TFTP Server: The IP address of the TFTP server containing the IP software.
2. Upgrade: Starts the IP software upgrade process.

## 7. FACTORY RESET

This option resets the SMT-i3105 to factory default settings.

## 8. PHONE RESTART

This option reboots the SMT-i3105 phone.

# SECTION 3. FREQUENTLY USED FEATURE OPERATION

This section provides the basic operation of your Samsung Multimedia Telephone **SMT-i3105**.

## LOGGING IN & OUT [If Hot Desking is Enabled]

If enabled, your SMT-i3105 telephone may require you to log in before making or receiving calls. In these cases your telephone system administrator will provide you with an extension number, password, and the feature code used to log out.

### TO LOG IN

- Dial your extension number in the ID field (example 3201).
- Press the **OK** button.
- Dial your password in the password field (default 1234).
- Press **Save** soft button.

### TO LOG OUT

- Dial the feature code provided by your administrator (log out code 77).

## PLACING CALLS

**IMPORTANT:** Put your phone in **Overlap Mode** by pressing the **Menu** button, select **Settings** and then select **Dial Mode**, change it to **Overlap**. If your phone is not in OVERLAP mode you must always press the **Call** soft button after dialing the digits to send the call.

**NOTE:** All examples of making phone calls are based on the phone being set for overlap dialing mode.

**OUTSIDE CALLS** - To place a call to an outside party:

- Lift the handset or press the **Speaker** button.
- Press an idle outside line button, line group button, or dial a line access code to receive dial tone.
- Dial the telephone number.
- Hang up the handset when the call is completed.

**NOTE:** Frequently called telephone numbers can be added to the PhoneBook.

When making internal and external calls from AOM list, press the **AOM** soft button to access the programmable button screens. Then use the **Call Log** (▲ Up) or **Phone Book** (▼ Down) button to scroll to and highlight the desired programmable button. Press **OK** to access trunk or trunk group, dial phone number.

**INTERNAL CALLS** - To place a call to another extension at your location:

- Lift the handset.
- Dial the extension number or group number.
- Wait for the party to answer. If you hear a brief tone burst instead of ringback tone, the station called is set for Voice Announce or Auto Answer. Begin speaking after the tone.
- Hang up the handset when the call is completed.

### NOTES:

1. If you have a **DSS** button assigned to an extension or station group, you may press this button instead of dialing the number.
2. If the Hot Keypad feature has been turned off, you must first lift the handset or press the **Speaker** button before you begin dialing.

**SPEAKERPHONE CALLS** - Your Samsung SMT-i3105 has speakerphone capability. This feature is used for both internal or external calls. To activate this feature:

- Press the **Speaker** button.
- Place an internal or external call.
- Press **Speaker** button to disconnect the call.

**NOTE:** The handset can be used at any time during the conversation. To resume handsfree operation, press the **Speaker** button, and hang up the handset.

## ANSWERING CALLS

**OUTSIDE/INTERNAL/VOICE ANNOUNCE CALLS** - To answer these three types of calls:

- Lift the handset or press the **Speaker** button to answer on **Speaker Phone**.
- Hang up the handset when the call is completed.

**NOTE:** The volume can be adjusted at any time by pressing the [+] and [-] **Volume** button arrow keys on your navigation button.

## PLACING A CALL ON HOLD

Calls can be placed on **System Hold** or **Exclusive Hold**. A call placed on System Hold can be picked up from any extension. Calls placed on Exclusive Hold can only be picked up from the extension that placed them on hold.

**SYSTEM HOLD** - To place a call on hold:

- Press the **Hold** button. The **Call** button will flash red at your telephone.
- To take the caller off hold, press that button and the red flashing light will go steady red again.
- Resume conversation.

**EXCLUSIVE HOLD** - To place a call on hold at your telephone so that other users cannot answer it:

- Press the **Hold** button **twice**. The call button will flash green at your telephone.
- To retrieve the call, press the flashing red line button or press the line button a third time.

**NOTE:** Internal calls are always placed on exclusive hold.

## TRANSFERRING CALLS

You can transfer a call by notifying the party to which the call is being transferred or without notification.

- While on a call, press the **Transfer** button then dial an extension number.
- Confirm you hear a ringback tone.
- Wait for the called party to answer and announce the call (optional).
- Replace the handset.

## TRANSFERRING WITH CAMP-ON

When you transfer a call to another station and receive a busy signal, you can camp the call on to this station. Hang up when you hear the busy signal. The called party is alerted that a call is waiting.

- Call another internal station.
- When receiving a busy tone, press the **Func.** soft button.
- Scroll to **Camp On** and press **OK** button (here ringback tone). Wait for party to answer the call.

**NOTE:** If you receive No More Calls tone, that station has no button available to receive another call. Press **Transfer** to return to the caller.

## CALL WAITING

If an outside call is camped-on to your phone or another station is camped-on to you:

- Your keyset rings and the call that is waiting (camped-on) flashes red.
- Press the flashing button to answer; the other call is put on hold automatically if your station has the Automatic Hold feature set. If not, you must press **Hold** and then the flashing button or finish the first call and hang up; the waiting call will ring.
- Lift the handset or press the **Speaker** button to answer.

**NOTE:** Intercom calls will not go on Automatic Hold.

## CONFERENCE CALLS

To make a conference call while engaged in a conversation:

- Press the **Conference** button and receive conference tone.
- Make another call, either intercom or outside, press the **Conference** button and receive conference tone.
- Make another call or press the **Conference** button to join all parties. You can conference up to five parties (you and four others).
- Repeat the last step until all parties are added. **Conf** a second time to put all calls bridged together.
- Hang up to leave the conference call.

**NOTE:** When attempting to add another party to the conference and you are not able to reach the desired person, hang up. Simply press the **Conference** button again to return to the previous conversation.

**To drop a party from your conference call:**

- Press the **Conference** button and dial the extension or line number that is to be dropped.
- Press the **Conference** button again to reestablish the conference.

## FORWARDING CALLS Icon

You can forward your calls to another station, group of stations, or an external telephone number. Program a destination for the type of forwarding you want by pressing **Menu**, then **Call Forward**, to set the forwarding number to **All**, **Busy**, **No Answer**, and **Busy/No Answer**.

## OTHER FEATURES AND FUNCTIONS

**VOLUME CONTROL - Vol** button is used to adjust the volume of a handset, speaker and ringing sound.

### Volume Control of a Handset

- Adjusts the handset volume while busy (handset offhook).
- To increase the volume of a handset, press the top side [+] of the **Vol** button.
- To decrease the volume of a handset, press the bottom side [-] of the **Vol** button.

### Volume Control of a Speaker

- Adjusts the speaker volume while busy in speaker mode.
- To increase the volume of a speaker, press the top side [+] of the **Vol** button.
- To decrease the volume of a handset, press the bottom side [-] of the **Vol** button.

### Volume Control of a Ringing Tone

- During an incoming call, to increase the volume of a speaker, press the top side [+] of the **Vol** button while ringing.
- To decrease the volume of a handset, press the bottom side [-] of the **Vol** button while ringing.

### Volume Control of Key Tone

- To increase the volume of the key tones, press the top side [+] of the **Vol** button.
- To decrease the volume of the key tones, press the bottom side [-] of the **Vol** button.

**NOTE:** By pressing the **Vol** button in idle mode, the user can also adjust the key tone volume.

**CALL LOG BUTTON** - Provides direct access to a list of the most recent calls, outgoing calls, incoming calls, missed calls, and an option to delete all (or clear) all calls from the call log. The **Call Log** button is also used to scroll (▲ Up) the soft menus display.

**PHONE BOOK BUTTON** - Provides direct access to the user's phonebook of stored contacts. The **Phone Book** button is also used to scroll (▼ Down) the soft menus display.

**OK BUTTON** - This function is used to enter, save or complete the selected option in the display.

**SPEAKER BUTTON** - This function is used to go on and off hook in the hands-free speakerphone mode.

**MENU SOFT KEY** - This menu displays the following options:

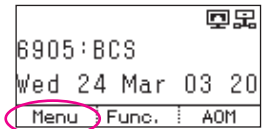

**NOTE:** The **Call Log** (▲ Up) and **Phone Book** (▼ Down) buttons can be used to navigate through these options.

1. **PHONEBOOK:** Maintains frequently dialed names and numbers in a PhoneBook. Search and initiate calls by: Speed Dial, Associated Names, or Telephone Numbers.
2. **CALL LOG:** Provides direct access to a list of most recent calls, outgoing calls, incoming calls, missed calls, and an option to delete all (or clear) all calls from the **Call Log**.
3. **MESSAGE:** This function allows users to select which desired type of messages is viewed. Users can select and view the following options: **Voicemail Messages, Station Messages, E-Mail** (optional with IP-UMS only), and **Short Message Service (SMS)**. Short Message Service is similar to sending text messaging [Function only supported to other internal station users with ITP or SMT-i phones].
4. **SOUND:** Sets Volume levels of various telephone functions. Scroll to select desired option setting. When setting Ring Type and Ringer Volume, each key tone level is heard while scrolling through them.
5. **SECURITY:** The function allows the user to lock or unlock an individual station from dialing out, and to change the station password. There are three options: **Unlock** (Station user is able to make any calls without restrictions), **Locked Out** (The station cannot make calls outside the system. The station can, however, make and receive internal calls and incoming CO calls, and outbound 911 emergency calls), and **Lock All Calls** (The station cannot make or receive any calls. Incoming, outgoing, internal calls and emergency calls are all blocked on a locked all station).
6. **CALL FORWARD:** Sends phone calls to a different station. Program a destination for the preferred forwarding options: **Disable, All, Busy, No Answer, Busy/No Answer, Do Not Disturb, and Follow Me Status**.
7. **SETTINGS:** This function allows the user to set the following option: **Dial Mode** (Overlap or Enbloc), **Language** (default English), **Network Information** (IP address, gateway, Server, etc), **Phone Information** (software version), **AOM Set**, and **Clear User Set**.

**FUNC. SOFT BUTTON** - This function allows a user one touch easy access to many of the system features. When pressed, the following options are displayed: **Last Number Redial, Save/Repeat, Speed Dial, Directory, VM Message, Station Message, Page Pickup, Direct Pickup, DND, In/Out Group, Status Message, Hold Pickup, Page, Meet Me Page, OHVA Block, Group Pickup, and My Group Pickup.** The **Call Log** (▲ Up) and **Phone Book** (▼ Down) buttons can be used to scroll up and down the list of features under the Func. button.

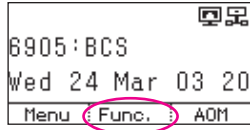

**Example of using the Last Number Redial feature:**

- Press the **Func.** Soft button, scroll to **Last Redial**, then press **OK** button. The last number called from the phone is called.

**NOTE:** [For detail operation of the list of features under the Func. soft button, please refer to the System Features section of the user guide.](#)

**AOM SOFT BUTTON** - This function is used to display all 99 programmable feature buttons of the phone. The **Call Log** (▲ Up) or **Phone Book** (▼ Down) buttons can be used to scroll up and down the list of 99 programmable feature buttons under the AOM module.

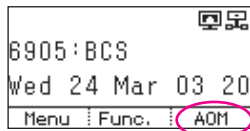

**Example of dialing a speed dial number using the AOM function:**

- Press the **AOM** soft button, scroll to **Speed Dial**, then press **OK** button. Enter the bin number (00~999).

**NOTE:** Some programmed features such as speed dialing and DSS buttons can be used to process calls; other programmed buttons such as Call buttons can only be viewed.

The soft AOM button can also display status indications for station keys, trunks, voice mail messages, etc.

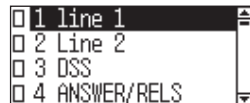

**Example of programming a DSS button on the soft AOM:**

- Press the **Menu** soft button.
- Using the **Call Log** (▲ Up) or **Phone Book** (▼ Down) buttons, scroll to **Settings** and press **OK**, then scroll to and select **AOM Setting**.
- Scroll to the soft **AOM** button to program (for example: 04).
- Press the **Edit** soft button (the display will show AOM index 4).
- Using the **Left and Right** soft buttons, scroll to the feature option (for example: DSS).

- Move down and enter the extension number (for example: 2003).
- Move down, use the dial pad to enter name (for example: John Dow). [Refer to Text Input Method.](#)
- Press the **Save** soft button to exit and save the setting.

## SECTION 4. PHONE FEATURES

## BASIC MENUS

The basic menu screen is displayed if you select the **Menu** from the soft menu at the left bottom of a idle screen. Using the **Call Log** (▲ Up) or **Phone Book** (▼ Down) buttons, move to a desired function, and press the [OK] button to execute the function.

### SOFT BUTTON STRUCTURE

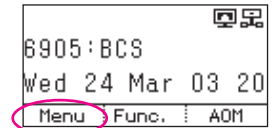

### MENU SOFT BUTTON

Item	Sub-Item	Description
<b>1. PhoneBook</b>	1. All List	Shows the entire list of phone numbers stored in the phonebook (00-99).
	2. Search Num	Allows a user to search for a stored phone number by name/number in your phonebook (case sensitive).
	3. Add to PB	Saves a phone number; and allows a user to specify a speed dialing name, number, and ringtone for incoming calls.
	4. Delete All	Allows a user to delete all the phone numbers saved in the phone.
<b>2. Call Log</b>	1. Recent	Lists the recent numbers of outgoing, incoming and missed calls.
	2. Outgoing	Lists the phone numbers of recent outgoing calls.
	3. Incoming	Lists the phone numbers of recent incoming calls.
	4. Missed	Lists the phone numbers of recent missed calls.
	5. Delete All	Allows a user to delete all the call history saved in the phone.
<b>3. Message</b>	1. Voice MSG [0]	Allows a user to retrieve voice mail messages from the mailbox.
	2. Station MSG [0]	Allows a user to retrieve station messages (internal) from another user.
	3. E Mail MSG [0]	Allows a user to view how many e-mail messages have been received via IP-UMS (optional).
	4. Short MSG [0]	Allows a user to retrieve and send internal short messages (SMS) like text message to other internal phones. <i>[Not Supported Over Networking]</i>

Item	Sub-Item	Description
<b>4. Sound</b>	1. Volume	Allows a user to adjust the volume of the ringtone, handset, speaker, key tone, page, and BGM Off Hook (OHVA).
	2. Ring Tone	Allows a user to select the ringtone.
	3. Key Tone	Allows a user to select the key tone sound.
<b>5. Security</b>	Change Password Phone Lock	Allows a user to secure the access to some menu items and change the station password.
<b>6. Call FWD</b>	A user can enable call forwarding when they have moved to another location or during a long absence. Options are Disable, All, Busy, No Answer, Busy/No Answer, DND, Follow Me.	
<b>7. Settings</b>	1. Dial Mode	Allows a user to set the dial mode as immediate dial (overlap) or wait dial (enbloc).
	2. Language	Sets the language of the phone.
	3. N/W Info	Shows the network setting information of the phone.
	4. AOM Set	Used to set buttons 00-99 on the soft AOM from the phone.
	5. Phone Info	Shows the software version of the phone.
	5. Clear User Set	Allows a user to delete their personalized data and return to the initial status.

## 1. PHONEBOOK

**NOTE:** Personal phonebook is stored locally in phone memory.

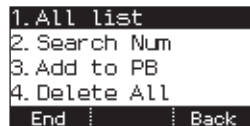

### 1. All List

Shows the entire list of phone numbers saved in the phone book.

- Press the **Phonebook** button—**OR**—press the **Menu** soft button, scroll to **Phonebook**, press **OK**, scroll to **All List**, and then press **OK**.
- The entire list of phone numbers saved in the phone book is shown on the screen. Using the **Call Log ▲ / Phonebook ▼** button, move to a desired number, and select the **Call** soft button to place a call.

### 2. Search Number

Allows a user to search by name/number for a phone number saved in the phone book.

- Press the **Phonebook** button—**OR**—press the **Menu** soft button, scroll to **Phonebook**, press **OK**, scroll to **Search Num**, and then press **OK**.
- Select from your saved numbers either **By Name** or **By Number** and press **OK**.
- From the dial pad enter the first characters of the name (case sensitive) or phone number to search and press the **OK** button, the matching phone number is displayed. Move to a desired name/number using the **Call Log ▲ / Phonebook ▼** button, and select the **Call** soft button to place a call.

### 3. Add to PB (Phonebook)

This is the function used to add a phone number to the phonebook.

- Press the **Phonebook** button—**OR**—press the **MENU** soft button, scroll to **Phonebook**, press **OK**, scroll to **Add to PB**, and then press **OK**.
- Enter a name and press **Next**.
- Enter a phone number and press **Next**.
- Select a ring tone by using the **Call Log ▲ / Phonebook ▼** keys.
- Press the **Save** soft button to save the phone number.

**NOTE:** See [Text Input Method](#) on how to enter name in the Phone Book.

### 4. Delete All

This is the function used to delete all the phone numbers saved in the phone book.

- Press the **Phonebook** button—**OR**—press the **Menu** soft button, scroll to **Phonebook**, press **OK**, scroll to **Delete All**, and then press **OK**.
- Press the **Yes** or **No** soft button to **Delete All** entries.

## 2. CALL LOG

### 1. Recent Outgoing Incoming Missed Icons

This function lists all the recent numbers for outgoing, incoming and missed calls.

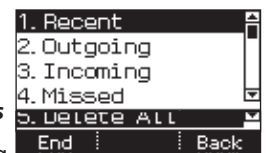

- Press the **Call Log** button—**OR**—press the **Menu** soft button, scroll to **Call Log**, press **OK**, scroll to **Recent**, and then press **OK**. A phone number list and icons of recent outgoing, incoming, and missed calls are displayed.
- Using the **Call Log ▲ / Phonebook ▼** button, move to a desired number, and press the **Call** soft button to place a call.



## 2. Outgoing Outgoing Calls Icon

This function lists the phone numbers of recent outgoing calls.

- Press the **Call Log** button—**OR**—press the **Menu** soft button, scroll to **Call Log**, press **OK**, scroll to **Outgoing**, and press **OK**. A phone number list of recent outgoing calls is displayed.
- Using the **Call Log ▲ / Phonebook ▼** button, move to a desired number, and press the **Call** soft button to place a call.

## 3. Incoming Incoming Calls Icon

This function lists phone numbers of recent incoming calls.

- Press the **Call Log** button—**OR**—press the **Menu** soft button, scroll to **Call Log**, press **OK**, scroll to **Incoming**, and press **OK**. A phone number list of recent incoming calls is displayed.
- Using the **Call Log ▲ / Phonebook ▼** button, move to a desired number, and press the **Call** soft button to place a call.

## 4. Missed Missed Calls Icon

This function lists phone numbers of recently missed calls.

- Press the **Call Log** button—**OR**—press the **Menu** soft button, scroll to **Call Log**, press **OK**, scroll to **Missed**, and press **OK**. A phone number list of recent missed calls is displayed.
- Using the **Call Log ▲ / Phonebook ▼** button, move to a desired number, and press the **Call** soft button to place a call.

## 5. Delete All

This function allows a user to delete the entire call history saved on the phone.

- Press the **Menu** soft button, scroll to **Call Log**, press **OK**, scroll to **Delete All**, and press **OK**.
- Enter the phone password [Enter 1234].
- Press **Yes** to delete all Call Log entries.

### VIEWING DETAIL CALL LOG RECORD

To view the details of each of the call log entry, highlight the entry and press the **OK** button to display the full Caller ID record which includes the name, date and time.

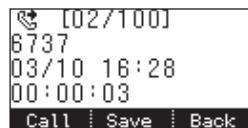

## 3. MESSAGE

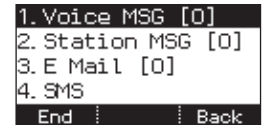

### 1. Voice Mail Messages

This function allows users to retrieve voice mail message from the mailbox.

- Press the **Menu** soft button, scroll to **Message**, press **OK**, scroll to **Voice MSG [ ]**, and then press **OK** to access the voice mailbox and retrieve messages. Enter password for voice mail.

### 2. Station Messages

This function allows users to retrieve station messages (internal) from another user.

- Press the **Menu** soft button, scroll to **Message**, press **OK**, scroll to **Station MSG [ ]**, and then press **OK**.
- To return a call to the station that left the message: press the **Func.** soft button, scroll to **Reply**, then press **OK**.
- To delete the station message: press the **Func.** soft button, scroll to **Clear**, then press **OK**.
- To view the next station message: press the **Func.** soft button, scroll to **Next**, then press **OK**.

### 3. E-Mail Messages

This function allows users to view the amount of e-mails for a station user's account. This function is only available when the IP-UMS application is enabled. Please refer to the IP-UMS manuals for detailed operation.

### 4. Short Message Service (SMS)

This function is used to send and create internal short messages or text messaging. Only operational within same node, not supported over networking.

#### INBOX

- Press the **Menu** soft button, scroll to **Message**, press **OK**, scroll to **Short Message [0]**, and press **OK**.
- Scroll to **Inbox**, then press **OK** to view a short text message in you Inbox.
- Press the **Del** soft button, the **Yes** soft button to delete the short text message or press the **End** soft button to exit SMS.

## NEW MESSAGE (SEND)

This function is used to create and send a new short text message.

- Press the **Menu** soft button, scroll to **Message**, then press **OK**. Scroll to **Short Message** [], then press **OK**. Scroll to **New Msg**, then press **OK**.
- Write or create a new short message and press the **Next** soft button. [See Text Input Method on how to enter characters in text messages.](#)
- Enter the internal extension(s) to send the short message. Scroll to other entries and enter the station number to send to more users. (Each short message can be sent to 1 to 10 users).
- Press the **Send** soft button to deliver the short message to other user's inbox.

**NOTE:** When the message is sent successfully, the message "Sent" is displayed. When the message fails to send the "Failed to send" is displayed. SMS messages can only be sent to internally ITP, SMT-W, or SMT-i phones within the same node. TDM and single line phones cannot send or receive SMS messages. SMS messaging is not supported over networking.

## OUTBOX

This function is used to edit and resend a new short text message.

- Press the **Menu** soft button, scroll to **Message**, then press **OK**. Scroll to **Short Message** [], then press **OK**.
- Scroll to **Outbox**, then press **OK** to view short text message sent from your phone.
- Scroll to the desired **SMS MSG**.
- Press the **Del** soft button, then **Yes** soft button to delete the short text message or press the **End** soft button to exit SMS.

**NOTE:** SMS messages indicated by X icon cannot be deleted from the Outbox.

## DELETE ALL

This function is used to delete the short message(s) saved in both the **Inbox** and the **Outbox**.

- Press the **Menu** soft button, scroll to **Message**, then press **OK**. Scroll to **SMS**, then press **OK**.
- Scroll to **Delete All**, then press **OK** to view short text message sent from your phone.
- Press the **Del** soft button to delete the short text message or press the **End** soft button to exit SMS.

**NOTE:** SMS messages indicated by X icon cannot be deleted from the Outbox.

## 4. SOUND

This function is used to adjust the selected volume levels on each phone. This is the same option as station lock in MMC 114.

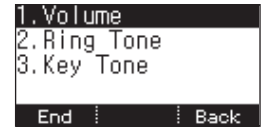

- Press the **Menu** soft button, scroll to **Sound**, then press **OK**. Scroll to **Ring Tone**, or **Key Tone** or **Volume**, then press **OK**.
- Using the **Call Log** ▲ / **Phonebook** ▼ buttons adjust the volume or sound, then press **OK** and **Save** soft button.

## 5. SECURITY

This function is used to select the option for each user to change station password, lock or unlock each phone. This is the same option as station lock in MMC 100.



- Press the **Menu** soft button, scroll to **Security**, then press **OK**.
- Enter the station password [default 1234].
- Press **OK** to **Change Password** and press **Back** soft button.
- In the **Dial** mode, use the **Left** [-] and **Right** [=] soft buttons to choose the **Unlock**, **Lock Out** (Outgoing), or **Lock All** option from the menu.
- In the **Menu** mode, use the **Left** [-] and **Right** [=] soft buttons to choose the **Unlock** or **Lock M** option (Station locked from changing the Dial Mode) from the menu.
- In the **Password** mode, enter the current password (eg; 1234)
- Enter the **New Password**. Re-enter the new password to confirm. Password is changed.

## 6. CALL FWD

This function is used to set/cancel call forwarding to each phone.

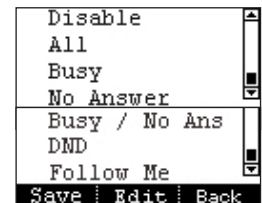

- Press the **Menu** soft button, scroll to **Call Fwd**, then press **OK**, scroll to forward option [**Disable**, **All**, **Busy**, **No Answer**, **Busy/No Answer**, **DND** or **Follow Me Status**], then press **Edit** soft button.
- Enter the **Station or Group Number** to forward calls, then press **OK** or **Save**.

## 7. SETTINGS

This function is used to allow station users to set the Dial Mode to Enbloc or Overlap dial, set the Language, view the station network Info settings, to view the phone firmware and boot version, or to clear user settings, such as the call log and phonebook.

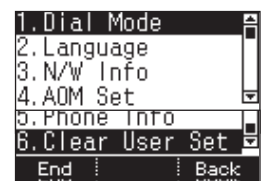

## DIAL MODE

- Press the **Menu** soft button, scroll to **Settings**, then press **OK**.
- Scroll to **Dial Mode**, then press **OK**.
- Using the **Call Log ▲ / Phonebook ▼** buttons select **Enbloc** or **Overlap**, then press **Save** soft button or press **OK** button.
- Choose **Overlap** to dial number and have it automatic dial out, use **Enbloc** to press # sign to dial.

## LANGUAGE

- Press the **Menu** soft button, scroll to **Language**, then press **OK**.
- Scroll to **Language**, then press **OK**.
- Using the **Call Log ▲ / Phonebook ▼** buttons select the language, then press **Save** soft button or press **OK** button.

## FUNC. SOFT BUTTON

This function allows a user one touch easy access to many of the system features. When pressed, the following options are displayed: **Last Number Redial**, **Save/Repeat**, **Speed Dial**, **Directory**, **VM Message**, **Station Message**, **Page Pickup**, **Directory Pickup**, **DND**, **In/Out Group**, **Status Message**, **Hold Pickup**, **Page**, **Meet Me Page**, **OHVA Block**, **Group Pickup**, and **My Group Pickup**. The **Call Log ▲ / Phonebook ▼** buttons can be used to scroll up and down the list of features under the **Func.** button.

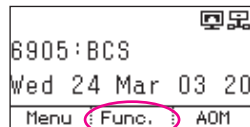

**NOTE:** [For detailed operation of the list of features under the Func. soft button, please refer to the System Features section of this user guide.](#)

## AOM SOFT BUTTON

This function is used to display all 99 programmable feature buttons of the phone. The **Call Log ▲ / Phonebook ▼** buttons can be used to scroll up and down the list of 99 programmable feature buttons under the AOM module. This feature button can be programmed by a technician.

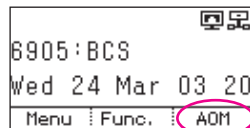

# SECTION 5. OFFICESERV™ 7000 SYSTEM FEATURES

# OUTSIDE CALLS

## MAKING CALLS FROM AOM

**Note:** When making calls, internal or outside calls, in order to access the programmable button screens, press the **AOM** soft button. Then you can utilize the **Call Log ▲ / Phonebook ▼** buttons on the display.

- When the desired number is highlighted, press the **OK** button.
- The number will be automatically dialed.

## UNIVERSAL ANSWER

Outside lines may be programmed to ring a general alerting device. To answer calls ringing this device, dial **67—OR—**press the **UA** button. This device can operate in any one of the six different ring plans.

**NOTE:** If the Hot Keypad feature has been turned off, you must first lift the handset or press the **Speaker** button before dialing.

## RECALL DIAL TONE

- Press the **New** button to disconnect your existing call, wait for dial tone and then make a new call on the same line.

**NOTE:** If this button does not appear on your keyset, the **Flash** button may be programmed to recall dial tone.

## SENDING A FLASH

While on an outside call, press the **Flash** button to send a flash to the telephone company. This is required for some custom calling features or CENTREX use.

**NOTE:** Flash is not available on an ISDN circuit.

## BUSY LINE QUEUING WITH CALLBACK

If you receive a busy signal when you are selecting an outside line, this means that the line or group of lines is busy.

- Press the **Callback** button, if programmed, or dial **44**, you will hear confirmation tone.
- Hang up or press **Speaker** button.
- When the line becomes free, the system will call you back.
- Lift the handset or press the **Speaker** button to answer, wait for dial tone and dial the telephone number or speed dial number again.

NOTES:

1. A callback will be canceled if not answered within 30 seconds. If you have set a callback, the cursor associated with the **Callback** button will be solid black.
2. If the Hot Keypad feature has been turned off, you must first lift the handset or press the **Speaker** button before dialing.

## BUSY STATION CALLBACK

When you call another station and receive a busy signal:

- Press the **Callback** button, if programmed, or dial **44**.
- When the busy station becomes free, your keyset will ring.
- Lift the handset or press the **Speaker** button to call the now idle station.

NOTES:

1. A callback will be canceled if not answered within 30 seconds. If you have set a callback, the cursor associated with the **Callback** button, will be solid black.
2. If the Hot Keypad feature has been turned off, you must first lift the handset or press the **Speaker** button before dialing.

## CANCELING CALLBACK

A callback will be canceled if not answered within 30 seconds. If you have set a callback, the cursor associated with the **Callback** button, will be solid black.

To cancel a callback:

- Press the **Callback** button, if programmed, or dial **44**. The display will show the callback details, press the **Func.** soft button and then **Clear**.
- This will cancel the last set callback and display the next set callback, also with the option to **Clear**. This process is repeated until all callbacks are cleared from memory.

**NOTE:** If the Hot Keypad feature is turned off, you must first lift the handset or press the **Speaker** button before dialing.

## BUSY STATION CAMP-ON

When you call another station and receive a busy signal but you do not want to wait for a callback:

### MANUAL CAMP-ON

- Press the **Camp** button or dial **45**.
- The called station will receive off-hook ring tone repeated every few seconds and the cursor associated with the first available **Call** button will flash black to indicate your call is waiting.
- Wait for the called party to answer.

- The called station must release its first call or place it on hold before answering your camp-on.

#### NOTES:

1. If you receive No More Calls tone, that station has no available button to accept your call. Hang up or leave a message.
2. If the Hot Keypad feature has been turned off, you must first lift the handset or press the **Speaker** button before dialing.

#### AUTO CAMP-ON

When you want to automatically camp on to a busy station without pressing the camp on button every time you call a busy station, you can set your phone for auto camp-on.

- With the handset on-hook, press **Transfer** and then dial **110**.
- Dial **081** to turn **ON** auto camp-on or dial **080** to turn it **OFF**.
- Press **Transfer** to store your selection.

## INTERCOM CALLS

### VOICE ANNOUNCE MODE

When another station calls you, your keyset will sound a brief attention tone and you will hear the caller's announcement.

- Press the **Speaker** button to turn on the microphone and speak handsfree—**OR**—lift the handset to reply.
- To finish the call, replace the handset or press the **Speaker** button.

NOTE: In order for C.O. calls to be answered handsfree, AUTO ANS CO must be set to ON.

### AUTO ANSWER MODE

When another station calls you, your keyset will sound a brief attention tone and then automatically answer the call.

- Your microphone and speaker are turned on and you can speak handsfree. For privacy, use the handset.
- To finish the call, replace the handset.

NOTE: In order for C.O. calls to be answered handsfree, AUTO ANS CO must be set to ON.

### CALLING YOUR SYSTEM OPERATOR

- Dial **0** to call your system operator or group of operators.
- If you want to call a specific operator, dial that person's extension number.

NOTE: If the Hot keypad feature has been turned off, you must first lift the handset or press the **Speaker** button or dial **0** before you begin dialing.

# CALL PROCESSING

## SYSTEM HOLD

When you are connected to any call, press **Hold**. The call will flash at the keyset. If this call appears on a line button at other keysets, it will flash at those keysets also.

- To take the caller off hold, press that button and the flashing LED will go steady again. Resume the conversation—**OR**—press the **Hold** button. The flashing LED will go steady again and you will be connected to the call again. Resume the conversation.

NOTE: While on a call, pressing a line button, route button or flashing **Call** button will automatically put your first call on hold and connect you to the new call. [See Automatic Hold under Customizing Your Keypad.](#)

## EXCLUSIVE HOLD

To place an outside call on hold at your phone so that other users cannot get it:

- Press the **Hold** button twice. The call will flash on your keyset and this line will show a steady indication on other keysets.
- To retrieve the call, press the flashing line button or press the **Hold** button a third time.

NOTE: Intercom calls will always be placed on exclusive hold.

## REMOTE HOLD

When you wish to place a call on hold at another station.

- Press **Transfer** and dial the station number (or press the appropriate **DSS** button)
- Press the **Hold** button. This will place the call on system hold on an available **Call** button or Line button at the remote station and return you to dial tone.

NOTES:

1. If the destination station does not have any free **Call** buttons or line buttons you will hear No More Calls tone and must return to the other party by pressing the **Transfer** button.
2. Intercom calls cannot be put on remote hold.

## HOLD RECALL

If you leave a call on hold longer than the hold timer, it will recall your station. The button that the call appears on will have a slow flashing indicator. (Telephone Status Indicator will flash amber).

- When your phone rings, lift the handset or press the **Speaker** button to answer the recall.
- If you do not answer this recall within a pre-programmed period of time, it will go to the system operator.

## CONSULTATION HOLD

When you are talking on an outside line and it is necessary to consult with another extension:

- Press the **Transfer** button; you will receive transfer dial tone. Your call is placed on transfer hold.
- Dial the extension number.
- Consult with the internal party.
- Press **Transfer** to return to the outside party or hang up to transfer the call.

NOTE: Repeatedly pressing the **TRANSFER** button will toggle between the outside party and internal extension. If necessary you may disconnect either one of the parties by pressing the **Func.** soft button, and then **Cancel**.

## RETRIEVING CALLS HELD AT ANOTHER STATION [HOLD PICKUP]

When a line is on hold and it appears on your keyset, press the **Line** button with the flashing indicator.

When a line is on hold and it does not appear on your keyset, dial **12** plus the line number or the extension number of the station that placed the call on hold.

NOTE: If the Hot Keypad feature has been turned off, you must first lift the handset or press the **Speaker** button before you begin dialing.

## CALL TRANSFER

Transfer is used to send any calls to another extension in one of two ways. You can do a screened transfer by informing the other extension who is calling or you can do a blind transfer without notification.

- While on a call, press the **Transfer** button and dial an extension number or group number. Your call is automatically put on transfer hold—**OR**—press a **DSS** button or station group button. Your call is automatically put on transfer hold.
- Hang up when you hear ringing (this is an unscreened or blind transfer)—**OR**—wait for the called party to answer and advise him/her of the call and hang up. If the transfer is refused, you will be reconnected to the outside line when the called station hangs up or you can press **Transfer** to return to the outside party.
- If you wish to send the call to another extension without waiting for the first station to hang up, simply press another **DSS** button—**OR**—press the **Call** button or C.O. line button to return to the outside party and begin the transfer process again.
- When you are transferring a call to a keyset set for Voice Announce or Auto Answer, the transferred call will always ring.

### NOTES:

1. After the inside party answers, you may alternate back and forth between the parties by pressing the **Transfer** button.
2. If you receive No More Calls tone, that station has no button available to receive another call. Press **Transfer** to return to the other party.
3. You cannot transfer an Intercom call by pressing a **DSS** button. You must press the **Transfer** button and dial the destination extension number.

## TRANSFER WITH CAMP-ON

When you are transferring a call to another station and you receive a busy signal, you may camp the call on to this station. Simply hang up when you hear the busy signal. The called party will be alerted that a call is waiting for them.

NOTE: If you receive No More Calls tone, that station has no button available to receive another call. Press **Transfer** to return to the outside caller.

## TRANSFER TO VOICE MAIL

This feature is used to send a call directly to a voice mailbox. Your keyset must have a correctly programmed **VT** button to accomplish this. To transfer a call directly to a voice mailbox:

- While on a call, press the **VT** button and dial the mailbox number.
- Hang up when dialing is completed.

## CALL WAITING

If an outside call has been camped-on to your phone or another station has camped-on to you:

- You will hear a tone in the earpiece and the call that is waiting for you (camped-on) will flash. In addition the bottom line of the display will indicate the number of the station or trunk party camped-on.
- Press the flashing button to answer; your other call will go on hold automatically if your station has the Automatic Hold feature set. If not, you must press **Hold** and then the flashing button—**OR**—finish the first call and hang up; the waiting call will ring.
- Lift the handset or press the **Speaker** button to answer.

NOTE: Intercom calls will not go on Automatic Hold. When using the speakerphone the camp-on tone will come through the speaker.

## CALL FORWARD OPTIONS

A display keyset may review or change call forward options and destinations. Call forward access can be done via the keypad or by accessing the keyset display features. To review or change call forward options:

- Press the **Menu** button, scroll to **Settings**, press the **OK** button.
- Scroll to **Call Forward** and press the **OK** button.
- Scroll to the desired Forwarding option, enter the destination extension, and press the Save soft button.  
—**OR**—
- Press **Transfer 102**.
- Dial **0-5** to select the forward type (e.g., 1)—**OR**—  
Press **Volume Up [+]** or **Volume Down [-]** to select the forward type  
Press the right soft key to move the cursor.
- Dial the destination number (e.g., **202**)—**OR**—  
Press **Volume Up [+]** or **Volume Down [-]** to select the destination and press the **Right** soft key to move the cursor.
- Dial **1** to set—**OR**—press **Volume Up [+]** or **Volume Down [-]** to select **Yes** or **No** and press **Transfer** to store and exit.  
—**OR**—

### To Forward ALL Calls to Another Station

- Dial **601** plus the extension or group number.
- Receive a confirmation tone and hang up.

### To Forward Calls to Another Station when you are on the Phone (BUSY):

- Dial **602** plus the extension or group number.
- Receive a confirmation tone and hang up.

### To Forward Calls to Another Station when you DO NOT ANSWER:

- Dial **603** plus the extension or group number.
- Receive a confirmation tone and hang up.

### When you have both Forward ON BUSY and Forward NO ANSWER Destination Programmed:

- You can activate them simultaneously.
- Dial **604**. Receive a confirmation tone and hang up.

### To Forward Calls when DND is Activated:

- Dial **605** plus the extension or group number.
- Receive a confirmation tone and hang up.

### To Forward Calls to the Station Where You Currently Are (FORWARD FOLLOW ME):

- Dial **606** plus the extension or group number.
- Receive a confirmation tone and hang up.

To clear all call forward conditions set at your station lift the handset and dial **600**.

## STATION CALL PICKUP

To pick up (answer) a call ringing at another station, lift the handset and dial **65** plus the extension number of the ringing phone. If you have a DP key assigned with a station number, you only need to press this **DP** (Direct Pickup) key with the flashing light to answer this ringing station. NOTE: If the Hot Keypad feature has been turned off, you must first lift the handset or press the **Speaker** button before you begin dialing.

## GROUP CALL PICKUP

To pick up (answer) a call ringing in any pickup group, lift the handset and dial **66** plus the desired group number (**01-10** on the **OfficeServ 7030**, **01-20** on the **OfficeServ 7200-S**, **01-99**, and **01-99** on the **OfficeServ 7000 Series**) or press the flashing **Group Pickup** button if available or **GRP PKUP** on AOM.

### NOTES:

1. A group pickup button can have an extender for a specific pickup group.
2. If the Hot Keypad feature has been turned off, you must first lift the handset or press the **Speaker** button before dialing the access code.

## MY GROUP PICKUP

If desired, a new access code can be assigned to pickup ringing calls in the same pickup group as you are in. Like "66" above except you do not need to dial the desired group number. See your installation company for the assigned access code. MY GROUP PICKUP: \_\_\_\_\_.

## PRIVACY RELEASE

This feature will allow another station to join in our conversation by releasing privacy on the C.O. from your phone.

**To Release Privacy:** While you are talking on a C.O. line and you wish to have other internal parties (or up to three) join the conversation.

- Press the **PRB** button (the **PRB** indicator will be steady). Inform the other party that he/she may now join the conversation.

After the other party (or parties) has joined the conversation and you wish to return privacy to the line so that no one else can join the conversation, press the **PRB** button a second time, the **PRB** button LED will be off.

**To Join a Non-Private Conversation:** When someone has informed you that you can join a conversation:

- Press the **C.O. line** button that he/she has indicated OR
- Dial the **C.O. line number** that he/she has indicated.



# DIALING FEATURES

All “DIALING FEATURES” instructions are written to support Overlap Dialing mode. This is the technical name for dialing from a telephone as it has been for many years. In recent years the cell phone industry has changed the cell phones to use Enblock Dialing. With this dialing mode all the digits are dialed and then sent to the carrier after pressing the **OK** key. Please check your telephone setup to confirm what dialing mode is used.

## SPEED DIALING

You can dial a preprogrammed telephone number stored in the system-wide speed dial list of numbers 500–999 or from your personal list of numbers 00–49.

Your system may be set for 950 system wide numbers. If so the system speed dial access codes are 050~999 and the station speed dial codes are 000~049.

- From the idle screen with the handset on-hook, press the **AOM** soft button, or dial **16**, scroll to the **Speed** button, press the **OK** button.
- Dial the desired speed dial bin number.
- The telephone number is automatically dialed for you.

NOTE: If the Hot Keypad feature has been turned off, you must first lift the handset or press the **Speaker** button before you begin dialing.

## PROGRAMMING PERSONAL SPEED DIAL NUMBERS

You can program frequently dialed telephone numbers in a personal speed dial list. A station may be assigned up to fifty numbers, **00–49**. See your system administrator to determine the amount assigned to your station. The phone itself maintains 1000 station speed dial numbers.

- While on-hook, press **Transfer** and then dial **105**.
- Dial a speed dial number (**00–49**).
- Dial a line or line group access code.
- Dial the telephone number to be stored (24 digits maximum). It can include #, \*, FLASH and PAUSE.
- Press **Transfer** to store the number.

NOTE: If the Hot Keypad feature has been turned off, you must first lift the handset or press the **Speaker** key before you begin dialing.

For the purposes of programming speed dial numbers, the programmable buttons are known as **A, B, C, D,** and **E**.

- The **A** button inserts a flash.
- The **B** button inserts a pause.
- The **C** button is used for pulse to tone conversion. If your system uses rotary (or pulse) dialing C.O. lines, pressing **C** while entering a speed dial number causes all subsequent digits to be sent as DTMF tones.
- The **D** button is used to hide digits. Display keyset users may want to hide some speed dial numbers so that they will not show in the display. When you are entering a telephone number, press **D**. All subsequent digits will be hidden. Press **D** again to begin displaying digits.
- The **E** button is used to enter a speed dial name. [See Personal Speed Dial Names under Display Features.](#)
- The **F** button toggles between speed dial name and number.
- Use the **Hold** button to clear a speed dial number.
- Use **Volume Up [+]** or **Down [-]** to advance cursor for Input of Bin Name.
- Use **Left** or **Right** soft button to save name.



## DIRECTORY DIALING

- Press the **Func.** soft button, scroll to **Directory**, press **OK**.
- Press **Func.** soft button, scroll to the desired **directory**, press **OK**.

**STATION DIRECTORY** - Accesses Station name directory.

**PERSONAL DIRECTORY** - Accesses your personal speed dial name list.

**SYSTEM DIRECTORY** - Accesses System speed dial name list.

- Enter the first letter of the desired party.
- Press the **Volume Up [+]** or **Down [-]** buttons to scroll to the desired entry.
- Press the **Func.** soft button.
- Select the appropriate operation below.
  - DIAL** - Dials the displayed number.
  - EXIT** - Exit programming and return to idle screen.
  - PREVIOUS** - Moves you to the previous entry.
  - NEXT** - Moves you to the next entry.
- Press **OK**.
- Press **End** soft button to return to idle screen.

## LAST NUMBER REDIAL

To redial the last outgoing telephone number you dialed, press the **Func.** soft button, scroll to **Last Redial**, or dial **19**. Press **OK**.

### NOTES:

1. If the Hot Keypad feature has been turned off, you must first lift the handset or press the **Speaker** button before you begin dialing.
2. Redial does not apply to intercom calls.

## SAVE NUMBER WITH REDIAL

While on a conversation, press the **Func.** soft button and select the **Save/Repeat** option before hanging up to save the number you just dialed for later use.

To redial this saved number at any time, press the **Func.** soft button, scroll to **Save/Repeat**, press **OK** button or dial **17**. The same line will be selected for you.

### NOTES:

1. If the Hot Keypad feature has been turned off, you must first lift the handset or press the **Speaker** button before you begin dialing.
2. The saved telephone number is stored in memory until you save another number.
3. Redial does not apply to intercom calls.

## AUTOMATIC REDIAL/RETRY

When you are making an outside call and you receive a busy signal, the system can automatically redial the number for you. It will automatically redial at a pre-programmed interval for up to 15 attempts.

- When you hear a busy signal, press the **Retry (Auto Retry)** button.
- The system will reserve the line and automatically redial the same number for you. You will hear the call being made through the keyset speaker. The microphone is muted.
- When the called party answers, lift the handset or press the flashing **Speaker** to begin speaking.

### NOTES:

1. If you make another call, auto-redial is canceled.
2. To cancel an auto-retry, lift and replace the handset.

## PULSE TO TONE CHANGEOVER

When making an outside call on a dial pulse line, press **#**. All digits dialed after the **#** will be sent as tones.

# PAGING AND MESSAGING

## MAKING AN INTERNAL PAGE

To make an announcement through the keyset speakers in the idle condition:

- Lift the handset.
- Press the **Func.** soft button, scroll to **Page** button, press **OK** or dial **55**.
- Dial the desired zone number **0, 1, 2, 3** or **4**.
- After the attention tone, make your announcement.

### NOTES:

1. If you have a dedicated page zone button, it is not necessary to press **Page** and dial a zone number.
2. If allowed by your system administrator you may be able to initiate a page from a speakerphone by pressing the **Page** key or dialing **55** without lifting the handset.

## MAKING AN EXTERNAL PAGE

To make an announcement through the external paging speakers:

- Lift the handset.
- Press the **Func.** soft button, scroll to **Page** button, press **OK** or dial **55**.
- Dial the desired zone number **5, 6, 7** or **8**—**OR**—dial **9** to page all external zones.
- After the attention tone, make your announcement.

### NOTES:

1. If you have a dedicated page zone button, it is not necessary to press **Page** and dial a zone number.
2. If allowed by your system administrator you may be able to initiate a page from a speakerphone by pressing the **Page** key or dialing **55** without lifting the handset.

## ALL PAGE

To page all designated keysets in internal zone 0 and all external zones at the same time:

- Lift the handset.
- Press the **Func.** soft button, scroll to **Page** button, press **OK** or dial **55**.
- Dial **\*** or press the **All Page** button.
- After the attention tone, make your announcement.

#### NOTES:

1. The LED on the **Page** button will only light when an All Page is in progress.
2. If allowed by your system administrator you may be able to initiate a page from a speakerphone by pressing the **Page** key or dialing **55** without lifting the handset.

## MEET ME PAGE

- Lift the handset.
- Press the Meet Me Page **MMPG (MMPAGE)** button or dial **54**.
- Dial the desired zone number (0~9).
- After the attention tone, instruct the paged person to dial **56**.
- Press **Func.** soft button, then **Answer Wait**, then **OK** button.
- Remain off-hook until the person dials **56** from any phone.
- The paged person will be automatically connected with you.

## CALL PARK AND PAGE

When you have an outside call for someone who is not at his/her desk, you can park the call prior to paging. The OfficeServ 100, OfficeServ 500, and OfficeServ 7000 Series systems offer two different methods:

#### MANUAL PARK ORBITS

- While in conversation, press the **Park** button.
- Entered a desired orbit number (**0-9**), if the orbit number is busy dial another orbit number. Display users can press **\*** to automatically place the call in any available orbit number and see the number in the display.
- Remember the selected orbit number.
- Replace the handset when finished.
- Lift the handset and make a page announcement as previously described (example: "John Smith park two").

#### To retrieve a parked call from orbit:

- Press the **Park** button and dial the announced orbit number (**0-9**).
- You will be connected to the parked call.

#### NOTES:

1. You must have a **Park** button or park access code to retrieve and place calls in park orbits.
2. If the parked call is not retrieved within a pre-programmed period of time, it will recall your keyset and have a slow flashing amber light. You cannot park and page intercom calls.
3. If the Hot Keypad feature has been turned off, you must first lift the handset or press the **Speaker** button before you begin dialing.

#### AUTOMATIC PARK WITH PAGE BUTTON

- While in conversation, press the **Page** button. The call is automatically parked at your station.
- Receive page tone and dial a desired page zone number.
- Make announcement indicating your extension number or the line number. Hang up.

#### To retrieve an automatically parked call:

- Dial **10** plus the number that was announced. If you have a **PAGPK (Page Pickup)** button, press it and dial the number that was announced. If you have a **Park** button, press it and dial the announced orbit number.
- You will be connected to the parked call.

#### NOTES:

1. If the call is not retrieved within a pre-programmed period of time, it will recall your keyset and have a slow flashing amber light. You cannot park and page intercom calls.
2. If the Hot Keypad feature has been turned off, you must first lift the handset or press the **Speaker** button before you begin dialing.

## SETTING A MESSAGE INDICATION

When you are calling another station and no one answers or you receive a busy signal, you can leave a message indication:

- Press the **Func.** soft button, scroll to **Message**, press **OK—OR—dial 43** and receive confirmation tone. Hang up.
- The message button on the Main Programmable Button screen and the TSI will flash red at the called station.

#### NOTES:

1. A station can have up to five message indications.
2. If the Hot Keypad feature has been turned off, you must first lift the handset or press the **Speaker** button before you begin dialing.

## CANCELING MESSAGES

To cancel a message indication that you left at another station, dial **42** plus the extension number of the station at which you left a message.

To cancel all message indications left at your keyset, dial **42** plus your extension. Your **Message** button indicator will stop flashing and the TSI will go out.

NOTE: If the Hot Keypad feature has been turned off, you must first lift the handset or press the **Speaker** button before you begin dialing.

## RETURNING MESSAGES

- Press **Menu**, scroll to **Message**, press **OK**, scroll to **Station Message**, press **OK**, press **Func.** soft button, **Reply**, and then press **OK**, or dial **43**. The first station that left a message will be called automatically. If that station does not answer, the called station **Message** button indicator will continue to flash and the TSI will stay on.
- Repeat until all messages have been returned in the order received.

### NOTES:

1. Display keyset users can view message indications and return them in any order. [See Viewing Message Indications under Display Features.](#)
2. If the Hot Keypad feature has been turned off, you must first lift the handset or press the **Speaker** button before you begin dialing.
3. If a message has been left at your keyset by a keyset in Auto Answer, you must manually cancel the message after it has been returned.

## PROGRAMMED MESSAGES

When you will be away from your phone for any length of time, you can leave a programmed station message. Display stations calling you will see this message and be informed of your status or follow your instructions.

- Dial **48** plus any of the message codes (**01–20**) listed on the back of this user guide.
- To cancel any of these messages you might have selected, dial **48** plus **00**.
- Press **Transfer** to exit and store your selection.

NOTE: If the Hot Keypad feature has been turned off, you must first lift the handset or press the **Speaker** button.

You can have multiple programmed message buttons (**PMSG**) and each one can have a different message code:

- Press any programmed message (**PMSG**) button. The message is set and the PGM MSG button indicator will be lit steady. Press the button again to turn off the programmed message and the indicator will go blank.
- Pressing another programmed message (**PMSG**) button will turn the previous one off and set a different programmed message.

## CONVENIENCE FEATURES

### LOGGING IN AND OUT

If enabled, your SMT-i3105 telephone may require you to log in before making or receiving calls. In these cases your telephone system administrator will provide you with an extension number, password, and the feature code used to log out.

#### To log in:

- At **Extension Login Screen** enter your ID which is your extension number.
- Scroll down to the password field and enter your station password
- Press on **Save** soft button or **OK** button.

#### To log out:

- Dial the feature code provided by your administrator (for example 77).

### DO NOT DISTURB

Use this feature when you want to block calls to your keyset.

- While on-hook, press the **Func.** soft button, scroll to **DND**, press **OK**, press **1** to turn it **ON**, or dial **401**. The Telephone Status Indicator will flash red intermittently to remind you of this mode.
- To cancel **DND**, press the **Func.** soft button, scroll to **DND**, press **OK**, press **0** to turn it **OFF**, or dial **400**. The Telephone Status Indicator goes blank. You can make calls while in the DND mode.

### NOTES:

1. If the Hot Keypad feature has been turned off, you must first lift the handset or press the **Speaker** button.
2. If you place your keyset in **DND** mode and you do not have a **DND** button, your **TSI** button will fast flash red to indicate DND status.

### ONE TIME DND

If you are on a call and you do not wish to be interrupted while on that call, you can press the **DND** button and place your station in Do Not Disturb. When you hang up at the end of the call, DND will be automatically canceled and your keyset will be able to receive new calls. This feature requires a **DND** button.

## MUTE

You can mute the handset transmitter or the microphone during any conversation:

- Press the **Mute** button. The **Mute** button indicator will be lit steady and the mute icon will show in the display.
- To resume speaking, press the **Mute** button again. The **Mute** button indicator goes blank.

## BACKGROUND MUSIC

When a music source is supplied, you may listen to music through the speaker in your keyset:

- While on-hook, press the **Hold** button to hear music.
- Press the **Hold** button again to turn music off.

You can set the level of background music by using the **Volume** buttons while listening to the music. This does not affect the speakerphone level.

## ESTABLISHED CALL PICKUP

To pick up an established call in progress at a single line extension connected to a computer modem on your PC.

- Press the **EP (EST PKU)** button for that station on your keyset and the call is automatically moved to your keyset.
- The single line extension on your modem will be disconnected.

NOTE: You must have an assigned (**EP** button) button on your regular keyset, for the single line station.

## ANSWERING THE DOOR PHONE

When you are programmed to receive calls from a door phone:

- You will receive three short rings repeated.
- Lift the handset. You are connected to the door phone.
- If an electric door lock release is installed, dial **13** to unlock the door.

NOTE: This is called **Door Unlock** in the display.

## CALLING THE DOOR PHONE/ ROOM MONITOR

You may call the door phone and listen to what may be happening outside or in another room.

- Dial the extension number of the door phone.
- You will be connected to the door phone and you can listen or have a conversation.
- If an electric door lock release is installed, dial **13** to unlock the door.

NOTE: If the Hot Keypad feature has been turned off, you must first lift the handset or press the **Speaker** button.

## GROUP LISTENING

When you are engaged on a call and you are using the handset, you may want other people to hear the distant party's voice over the speaker:

- Press the **Listen (Group Listen)** button to turn on the speaker. The microphone is not in use, so the distant party does not hear other parties present in your office.
- Press **Listen (Group Listen)** again to turn the speaker off and resume private conversation.
- Repeat if necessary.

NOTE: Depending on speaker volume and the acoustics of your office, it may be advisable to turn the group listening feature off before hanging up. This will eliminate a momentary squeal.

## ACCOUNT CODES

When enabled, your system allows calls to be charged to different accounts. You can enter account codes either by dialing the full code, by entering an account code "bin number"; or by pressing your **ACC (Account)** key if one is assigned. Bin numbers are a 3 digit short code that will automatically insert the appropriate account code. Account codes may be a maximum of 12 digits (# may be used); if the account code is to be less than 12 characters you may end the code by pressing **\*** or the right soft key. The type of code used is determined by your telephone system administrator. Codes can be entered before or during a call as follows:

**To enter an account code before placing the call:**

- Press your **ACC (Account)** key or dial **47**.
- Dial the account code or bin number.
- You will receive a confirmation tone and display.

- When prompted dial a trunk or trunk group (i.e. 9) and the telephone number to call.

**To enter an account code by interrupting the conversation:**

- While on an outside call press the **ACC (Account)** key or press **Transfer** followed by **47**.
- Dial the account number or bin number (if you are entering an account code you will need to press your **ACC (Account)** key or right soft key to finalize the entry)

NOTE: If you make an error simply repeat the procedure with the correct code. Only the most recent account code dialed will be recorded.

## MANUAL SIGNALLING

Use this feature when you want to send a brief 500ms ring burst to another station, regardless of the status of your phone (on-hook, off-hook, handsfree, DND, or ringing).

**To send a signal to another station:**

- Press the Manual Signalling (**MS**) button with extender.
- You may press the **MS** button repeatedly to send multiple signals to the designated station.

NOTE: Your phone must have a Manual Signalling (MS) button with a station number extender assigned to it. Manual Signalling will override DND.

## OFF-HOOK VOICE ANNOUNCE

Keysets may receive a voice announcement while on another call. The calling station must have an **OHVA** button. When you are in DND, you cannot receive OHVA calls. The OHVA feature will work with intercom and transferred calls.

When you receive an OHVA and secure OHVA is ON, you will hear the announcement in the handset receiver, if you are using the handset. If secure OHVA is OFF then you will hear the announcement on the speaker, if you are talking on the handset. If you are using the speakerphone the announcement will always be heard through the speaker.

**To make an off-hook voice announcement:**

- Dial the extension number or press the **DSS** button.
- When you receive a busy signal, press the **OHVA** button.
- After the attention tone, begin speaking.
- Finish the call by replacing the handset.
- Press the flashing **Call** button on your keyset. This will place the original party on hold and allow you to talk to the announcing party.

- To return to your first party, press the button corresponding to your original call. This will disconnect the OHVA call.

NOTES:

1. When you are voice announcing to a station close to you, use the handset to avoid an echo effect.
2. You cannot off-hook voice announce to single line telephones.

## OHVA BLOCK

Your keyset can be programmed with an OHVA Block (**Block**) button. Pressing this button will prevent anyone from making an OHVA to you until you press the button again and cancel the blocking.

## OHVA REJECT

Your keyset can be programmed with an OHVA Reject (**Reject**) button. Pressing this button while receiving an OHVA call will disconnect the voice announcing party and return you to your original call.

## IN GROUP/OUT OF GROUP

If your keyset is assigned to a station ring group, you can remove your keyset from the group and then put it back in. While you are out of the group, you can receive calls to your extension number but not calls to the group number. If you have an **IO GRP (IN/OUT GRP)** button with the group number assigned.

- Press the **IO GRP (IN/OUT GRP)** button. The button indicator will be lit steady when your keyset is in the group.
- Press the **IO GRP (IN/OUT GRP)** button again to exit the group and the indicator will go blank. Repeat as necessary.

If you do not have an **IO GRP (IN/OUT GRP)** button:

- Dial the **IO GRP (IN/OUT GRP)** access code number \_\_\_\_\_, then the group number, then **0**, press **Call** soft button to exit the group or **1** then press **Call** soft button to enter the group.

NOTE: If the Hot Keypad feature has been turned off, you must first lift the handset or press **SPEAKER** button.

The **IO GRP (IN/OUT GRP)** button can include an extender to indicate the specific group that this button will affect. This means that if you are in multiple groups, you can decide for which groups you will receive calls.

# CUSTOMIZING YOUR KEYSSET

## AME PASSWORD

This feature allows customers using the AME feature to enable password protection. This will prevent unauthorized users from listening to your messages being left. The passcode is the same as your station passcode. This feature only applies if there is a Samsung Voicemail card installed in the system and your keyset has a programmed AME button.

- With the handset on-hook, press **Transfer** and then dial **110**.
- Dial **101** to turn on AME PASSCODE or **100** to turn it off.
- Press **Transfer** to store your selection.

## AUTO CAMP-ON

This option allows intercom calls to be automatically camped on, if possible, when a busy station is called.

- With the handset on-hook, press **Transfer** and then dial **110**.
- Press **081** to turn CAMP-ON on or **080** to turn it off.
- Press **Transfer** to store your selection.

## SELECT RING TONE

Each SMT-i3105 user can select from a variety of ring tones.

### From the LCD:

- Press **Menu** button.
- Scroll to **Sound** option and press **OK**.
- Select **Ring Tone** and press **OK—OR—**you may dial **1** and immediately enter the option.
- Use **Volume Up [+]** or **Down [-]** buttons to scroll through the available ring tones and press **OK** or **Save** soft button to store your selection.
- Press **End** soft button to return to idle screen.

## CHANGE YOUR PASSCODE

From the factory, your station passcode is 1234. You can change your station passcode whenever you desire.

- While on-hook, press **Transfer** and then dial **101**.
- Dial your old passcode.
- Dial a new passcode (must be four characters). You can use **0–9**.

- Redial the new passcode. If successful, you will hear two beeps. Four beeps indicate an incorrect code to confirm, reenter the code again.
- Press **Transfer** to store the new passcode.

## SET ANSWER MODE (INTERCOM)

You can receive internal calls in one of three modes ([see Answering Intercom Calls under Intercom Calls](#) for descriptions).

- While on-hook, press **Transfer** and then dial **103**.
- Dial **0** for Ringing, **1** for Auto Answer or **2** for Voice Announce.
- Press **Transfer** to store your selection.

NOTE: When your keyset is programmed for Voice Announce and you have Forward No Answer (FNA) turned on, you must answer screened transfers by pressing the **OK** button before your FNA timer expires or the call will forward.

## SET ANSWER MODE (CO)

Your incoming CO calls can be set to follow the intercom answer mode.

- While on-hook, press **Transfer** and then dial **110**.
- Dial **15** to access **AUTO ANS CO**.
- Press the **Volume Up [+]** or **Down [-]** key to change status (**On/Off**).
- Press **Transfer** to store your selection.

## AUTOMATIC HOLD

While on an outside call, pressing a line button, route button or a flashing **Call** button will automatically put your call on hold and connect you to the next call. This feature can be turned on or off at your keyset.

- With the handset on-hook, press **Transfer** and then dial **110**.
- Dial **001** to turn Automatic Hold on or **000** to turn it off.
- Press **Transfer** to store your selection.

## HOT KEYPAD

On your phone system your keyset's keypad can be made "live" or "hot" so that it is not necessary to lift the handset or press the **Speaker** button before you begin dialing. Calls can be made and features activated by simply dialing the C.O. line number, trunk group access code, intercom number or feature access code.

- With the handset on-hook, press **Transfer** and then dial **110**.
- Dial **031** to turn the Hot Keypad on or **030** to turn it off.
- Press **Transfer** to store your selection.

## KEY CONFIRMATION TONE

You can hear a short beep (confirmation tone) each time you press a button on the dial pad. This tone can be turned on or off.

- While on-hook, press **Transfer** and then dial **110**.
- Dial **040** to turn tones off or **041** to turn tones on.
- Press **Transfer** to store your selection.
- Additional ring tones can be selected from the **Menu, Sound, Keytone**, option.

## REJOINING A PAGE

This feature allows you to hear the remaining portion of an ongoing internal page after you return your keyset to idle. To enable this feature:

- With the handset on-hook, press **Transfer** and then dial **110**.
- Dial **051** to turn this feature on or **050** to turn it off.
- Press **Transfer** to store your selection.

## RING PREFERENCE

This feature automatically answers ringing calls when you lift the handset or press the **Speaker** button. This method will always answer calls in the order they arrived at your keyset. When you turn ring preference off, you must press the flashing button to answer a call, allowing you to answer calls in the order you choose.

- With the handset on-hook, press **Transfer** and then dial **110**.
- Dial **061** to turn ring preference on or **060** to turn it off.
- Press **Transfer** to store your selection.

## DISPLAY SPEED DIAL NAME

This option allows you to view the name associated with a speed dial number as it is dialed.

- With you handset on-hook, press **Transfer** and then dial **110**.
- Press **111** to turn **DISP SPDNAME** on or **110** to turn it off.
- Press **Transfer** to store your selection.

## CALLER ID REVIEW ALL

This feature allows display keyset users to review Caller ID information for calls sent to their stations. This list can be from ten to fifty calls in a first in, first out basis. The list includes calls that you answered and calls that rang your station but that you did not answer. When reviewing this list, you can press one button to dial the person back. The system must be using LCR to dial the stored number.

- With you handset on-hook, press **Transfer** and then dial **110**.
- Press **121** to turn **CID Review All** on or **120** to turn it off.
- Press **Transfer** to store your selection.

## SECURE OHVA

This option allows you to receive OHVA (Over Head Voice Announce) calls via the speaker while you are on the handset.

- With your handset on hook, press **Transfer** and then dial **110**.
- Press **131** to turn **SECURE OHVA On** or **130** to turn it **Off**.
- Press **Transfer** to save your selection.

## CONFIGURE MOBILE EXTENSIONS (MOBEX)

This feature allows you to configure options for any Mobile Extension (MOBEX) ports that are assigned to you by your telephone system administrator. You can turn a port on or off; set the telephone number for the port; or set the caller ID you will be calling in from. The caller ID field has no effect unless you have been authorized as an Executive MOBEX user. Check with your telephone system administrator for further details on your specific system configuration.

**To set the phone number a MOBEX port can reach you on:**

- Press **Transfer** and then dial **126**.
- Dial your station passcode.
- Dial the number of the port you wish to configure (1-5) (you may also use the **Volume Up [+]** or **Down [-]** keys to select a port and press the right soft key to confirm).
- Press **Right** soft button to move to telephone number.
- Dial the number of a C.O. line or Trunk Group to use when making calls to this MOBEX port.
- Dial the phone number you can be reached at by users calling this MOBEX port.
- Press **Transfer** to store your selection and exit programming.



### To set the caller ID of the location you will be calling in from:

- Press **Transfer** and then dial **126**.
- Dial your station passcode.
- Dial the number of the port you wish to configure (1-5) (you may also use the **Volume Up** [+] or **Down** [-] keys to select a port and press the right soft key to confirm).
- Press **Right** soft key, then **Volume Up** [+] key, then press **Right** soft button again.
- Dial the phone number you will be calling in from.
- Press **Transfer** to store your selection and exit programming.

### To turn a MOBEX port ON or OFF:

- Press **Transfer** and then dial **126**.
- Dial your station passcode.
- Dial the number of the port you wish to configure (1-5) (you may also use the **Volume Up** [+] or **Down** [-] keys to select a port and press the right soft key to confirm).
- Press **Right** soft button to move the cursor down.
- At **TEL**, dial **2** on dial pad to advance to **DEACT**.
- Dial **1** to set to **Yes**.
- Press **Transfer** to store your selection and exit programming.

## DISPLAY FEATURES

### DIRECTORY INFORMATION

An 11 character directory name can be assigned to each extension number. Display keyset users can view the name of the called or calling station before answering.

Each outside line can have an 11 character directory name. Incoming calls can be easily identified and answered with different greetings.

Outside and internal calls ringing to a station group will display [CALL FOR xxx] where xxx is the station group number. This allows you to answer calls directed to you differently than calls directed to your group.

### DISPLAY NUMBER DIALED

Display keysets begin showing digits as they are dialed. They will stay in the display until the call duration timer comes on automatically or the **Timer** button is pressed. If the call duration timer is not used, the number dialed will be displayed until the call is released, transferred or put on hold.

### CALL DURATION TIMER

The system can be set to automatically time outside calls. A few seconds after you dial a telephone number, the timer appears in the display. It appears immediately for incoming calls. The call timer continues for the duration of the call. Call duration times are displayed in minutes and seconds. If a call lasts longer than 60 minutes, the timer restarts.

You can press the **Timer** button to manually begin timing a call. Press it again to stop timing. If you press it while the automatic timer is on, the call duration time is restarted.

### AUTO TIMER

Display keyset users may have the timer automatically start when they answer incoming calls or after a short delay on an outgoing call.

- With the handset on-hook, press **Transfer** and then dial **119**.
- Dial **41** to turn the auto timer on or **40** to turn it off.
- Press **Transfer** to store your selection.

## TIMER FUNCTION

Display keyset users may use this feature as a simple stopwatch.

- When the keyset is idle, press the **Timer** button to start timing.
- Press the **Timer** button again to stop timing.
- Read the elapsed time in the display.
- Lift the handset and replace it. The display will return to date and time.

## VIEWING STATION MESSAGE INDICATIONS

You can view all of your message indications before you return them:

- With the handset on-hook, press the **Message** button with the flashing indicator.
- The first station that left a message indication will be displayed.
- Press the **Volume Up** [+] or **Volume Down** [-] buttons to scroll through the stations that left message indications. Use the soft keys to reply, clear or advance to the next message.
- Press the **End** button to return your keyset to the idle condition.

## PERSONAL SPEED DIAL NAMES

Each personal speed dial number can have an 11 character name assigned to it. This name is used to select the speed dial bin when you are dialing by directory.

- Press **Transfer** and then dial **106**.
- Dial the speed dial bin number **00–49**.
- Enter the station name using the keypad. [See Station Names.](#)
- Press the **Transfer** key to store the speed dial name.
- Repeat for each speed dial bin if necessary.

NOTE: Use the Navigation button to move the cursor left or right, and use the **Volume Up** [+] or **Volume Down** [-] buttons to increment the speed dial bins.

[See Programming Personal Speed Dial Numbers Section.](#)

## STATION NAMES

- With the handset on-hook, press **Transfer** and then dial **104**.
- Enter the **Station Name**. Use the **Volume Up** [+] or **Volume Down** [-] buttons to move the cursor.
- Press **Transfer** to store the name.

## MANAGING PROGRAMMABLE KEY ASSIGNMENTS

You can manage your key assignments for easy one touch operation of frequently used features.

- While on-hook, press **Transfer** and then dial **107**.
- Use the **Volume Up** [+] or **Volume Down** [-] buttons to scroll through all of your programmable buttons.
- Press **Transfer** to exit programming.

To program the programmable keys, press **Menu, Settings, AOM Setting**.

For example:

**If you want to press a key that will direct calls to Joel at extension 3201.** Select an empty key and set the following:

- Feature: DSS
- Ext. Number: 3201
- Display Name: Joel

**If you want to press a key that will direct calls to Sue's external phone number at 972-444-3456.** Select an empty key and set the following:

- Feature: Speed
- Ext. Number: 01
- Display Name: Sue
- Use Transfer 105 to set speed dial number: [xxxx] SPEED DIAL  
01: 9-9724443456

Please consult your installation company to requested a complete list of descriptions for any keys you may have programmed on your keyset.

NOTE: Confirm that the cursor is placed correctly before you enter the extender.

## BACKSPACE WITH LCR

If you misdial while using LCR, you can delete digits shown in the display by pressing the **Backspace** soft key as many times as necessary or by pressing **Clear** to delete all.

# CALLER ID

## SELECTING YOUR CALLER ID DISPLAY

Simultaneous display of Caller ID name and number on incoming CO calls on both lines of display keysets is supported on all OfficeServ systems. On Transferred CO calls, you can decide if you want to see the Caller ID name or Caller ID number in the display. Regardless of which data is selected, you can press the NND button to view the other pieces of Caller ID information. To select the type of Caller ID information you wish to view:

- With the handset on-hook, press **Transfer** and then dial **119**.
- To set the first line of a ringing call display dial **0**.
- To set the second line of a ringing call display dial **1**.  
Set the data to display from the following:
  - To set for Conversation Incoming dial **2**.
  - To set for Trunk Display dial **3**.
  - To set for Time/Cost dial **4**.
  - To show nothing dial **0**.
  - To show Caller ID Number dial **1**.
  - To show Caller ID Name dial **2**.
  - To show the DID Number the call came in on dial **3**.
  - To show the Name of the DID the call came in on dial **4**.
  - To show the Name of the Group the call came in for dial **5**.
  - To show the DID Number and then Name of the DID dial **6**.
  - To show the Name of the DID and then the DID Number dial **7**.
- To set the top line of the display shown after answering a call dial **2**.  
Set the data to display from the following:
  - To show Caller ID Number dial **0**.
  - To show Caller ID Name dial **1**.
  - To show the DID Number the call came in on dial **2**.
  - To show the Name of the DID the call came in on dial **3**.
  - To show Caller ID Number and then the DID Number dial **4**.
  - To show Caller ID Name and then the DID Number dial **5**.
  - To show the DID Number and then the name of the DID dial **6**.
  - To show the Name of the DID and then the DID Number dial **7**.
  - To show the C.O. line information dial **8**.
- To set the format if the C.O. line information when the above is set to show C.O. line information dial **3**.
  - To show the C.O. line number and the dialed or Caller ID Number dial **0**.
  - To show only the dialed or Caller ID Number dial **1**.
- Press **Transfer** to exit and store your selection.

## VIEWING THE NEXT CALLER ID CALL

In the event that you have a call waiting or a camped-on call at your keyset, you can press the **Next** button to display the Caller ID information associated with the call in queue at your keyset. Either the CID name or CID number will show in the display depending on you Name/Number selection.

To view Caller ID information for calls that have been camped-on to your keyset, press the **Next** button.

## INQUIRE CALLER ID PARK/HOLD INFO

If you are informed that an incoming call is on hold or has been parked for you, you may view the Caller ID information before you retrieve the call. This may influence how you choose to handle the call.

### From an idle keyset:

- Press the **Inquire** button—**OR**—press **CID** button, then **Func.** soft button, and the **Inquire** soft key.
- Dial the trunk number.
- You may now answer the call by pressing the **ANS** button—**OR**—you may use **Func.** soft button and **NND** to view more information about this call—**OR**—you can return to the idle condition by pressing **Ignore**.

### If you are on a call:

- Press the **Func.** soft button and then **Inquire** button. Your existing call will go on hold—**OR**—press the **CID** button and **Func.** soft button then **Inquire** soft button to place the first call on hold.
- Dial the trunk number.
- You may now answer the call by pressing the **Func.** soft button then the **ANS** button—**OR**—you may use **NND** to view more information about this call—**OR**—you can return to the idle condition by pressing the **Func.** soft button and then **Ignore**.

### NOTES:

1. If you are on an intercom call or you have Automatic Hold turned off, you must finish the existing call or place it on hold before inquiring.
2. If you inquire about an outgoing call, you will receive a [call no longer available] display.

# FEATURE ACCESS CODES

## Paging Zones - Dial 55 plus

- 0 \_\_\_\_\_
- 1 \_\_\_\_\_
- 2 \_\_\_\_\_
- 3 \_\_\_\_\_
- 4 \_\_\_\_\_
- 5 \_\_\_\_\_
- 6 \_\_\_\_\_
- 7 \_\_\_\_\_
- 8 \_\_\_\_\_
- 9 All External Zones
- \* All Page

## Feature Access Codes

0	Operator	56	Meet Me Answer
10 + xxx	Pick Up A Parked Call	600	Cancel All Call Forward
12 + xxx	Pick Up a Held Call	601 + xxx	Set Forward All Calls
13	Door Lock Release	602 + xxx	Set Forward Busy
16 + xxx	Speed Dialing	603 + xxx	Set Forward No Answer
17	Save And Redial Number	604 + xxx	Set Forward Busy/No Answer
18	New Call (Recall)	605 + xxx	Set Forward on DND
19	Last Number Redial	606 + xxx	Set Forward Follow Me
400	Cancel Do Not Disturb	65 + xxx	Pick Up Ringing Extension
401	Do Not Disturb	66 + xx	Pick Up Group
42 + xxx	Cancel Sent Message	67	Universal Answer
43	Return Message	*	Authorization Code
44	Callback		
45	Busy Station Camp-On		
46	Conference		
47	Account Code		
48 + xx	Cancel Programmed MSG		
49	Send Flash to C.O. or PBX		
53 + xxx + 1	In Group		
53 + xxx + 0	Out of Group		

## SECTION 6. APPLICATIONS

NOTE: For additional access codes contact your system administrator.

# Samsung Voicemail

This section describes how to setup and use the various features available to a Subscriber. A Subscriber is a person that has been authorized access to the various features and services available in the Samsung Voicemail. Please review this section carefully before you use your Authorized Features and Services, known as Subscriber Services.

Voice Mail is one of the Subscriber Services available. Your voice mail box has the capability of storing private messages, and offers a number of options for sending or redirecting messages as well as provides several ways to notify you of new messages.

Another very common Subscriber Service is Access Manager. This allows you control over when and where you receive your calls as well as what to speak to your callers in the event you are unable to speak to them directly. The 'events' are referred to as "Call Conditions". No-Answer, Busy, and Blocked are the most commonly used Call Conditions.

This guide can be used by Subscribers from within the office or from telephones outside the office. The basic operation is the same, but the access method will be different. [See the Subscriber Services Menu Diagram for more details.](#)

Note that some features and prompts detailed here may not be available to all Subscribers. See your System Administrator if you have questions about feature availability.

## ACCESSING YOUR MAILBOX

*[Also known as Subscriber Services Menu]*

### Inside Callers *[Subscriber logging in from their Desk]*

- Dial the voicemail access number or press the key assigned to ring voicemail **[VMMSG]**.
- Enter your personal password when prompted (the default password is 0000).

### Outside Callers *[Subscribers calling from Cell Phones or outside of the office environment]*

- Dial the phone number that will be answered by the voicemail. The main greeting will answer.
- At the main greeting dial **[#]** plus your Subscriber (or mailbox) number (Subscriber and Mailbox numbers will usually match your extension number).
- Enter your personal password when prompted (the default password is 0000).

### Access your Subscriber Services (or Mailbox) from a Station other than your Own (or checking a mailbox associated with a different station)

- Press the **[VMMSG]** key or dial the voicemail **group number**. You will be prompted to enter a password.
- Press **[\*]**. This will take you to the Main Auto Attendant Menu.
- Press **[#]** plus the Subscriber number of your choice. You will be prompted to enter your password.

At this point the inside and outside callers follow the same instructions. You will hear a message stating the number of messages left in your mailbox. You will then hear the Subscriber Services Menu with the following options:

- 1 Listen to New Messages - [See Listening to your Message.](#)**
- 2 Record and Send Message - [See Sending Messages.](#)**
- 3 Review Saved Messages - [See Listening to your Message.](#)**
- 4 Access Manager - [See Access Manager.](#)**
- 5 Personal Greetings - [See Personal Greetings.](#)**
- 6 Mailbox Administration - [See Mailbox Administration.](#)**
- # Personal Services - [See Personal Services.](#)**
- \* Return to Main Menu.**

When accessing and retrieving voicemails from the mailbox, the service options such as **(1) Listening to Messages**, **(2) Record and Send Messages**, and **(3) Review Saved Messages** are available and can be accessed through the dial pad or through the **Function** soft key. When pressing the function soft button the options will be displayed. Scroll to and press the **OK** button to select an option from the **Function Menu**.

# Subscriber Services Menu

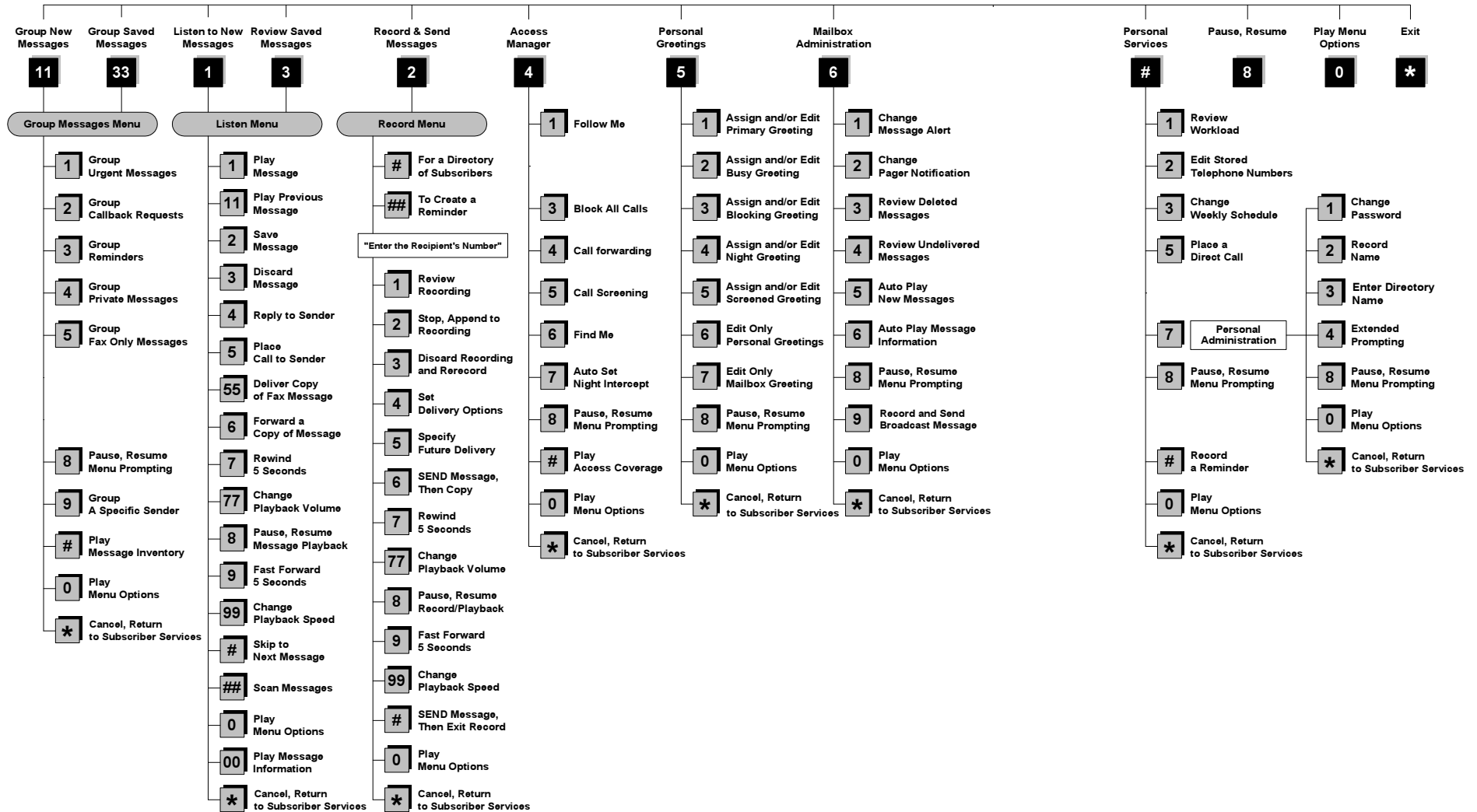

NOTE: All options shown MAY NOT be authorized. If an option is not available please speak to your system administrator.

\*Change Playback Speed and Volume not available on the OfficeServ 7030, OfficeServ 7100, OfficeServ 7200-S or OfficeServ IP-UMS.

## GETTING STARTED

Using your new Samsung Voicemail Subscriber Services is as simple as following a few simple spoken instructions. First time users should read this section as a tutorial. You should start with the following steps:

- Access your Subscriber Services Menu - You already know how to do this.

### From the Subscriber Services Menu:

- Record a Primary/No-Answer Personal Greeting. Dial **[5][1]**.
- Record a Mailbox Greeting. Dial **[5][7]**.
- Change your access code (Password). Dial **[#][7][1]**.
- Record your name. Dial **[#][7][2]**.
- Enter your directory name. Dial **[#][7][3]**.

After you have completed the steps above your Subscriber Services are set up and ready to use.

## LISTEN TO YOUR MESSAGES

If there are new messages in your mailbox your **[VMMMSG]** key will be lit. Call the Samsung Voicemail by pressing this key, and when prompted enter your password. You will then be at the Subscriber Services Menu. Select **[1]** to listen to new messages or **[3]** to listen to saved messages.

Note: After you enter your password, if "Autoplay of New Messages" is enabled and you have new messages the Samsung Voicemail will begin to play them automatically. A subscriber can control this feature. From the Subscriber Services Menu **[6][5]** toggles "Autoplay of New Messages" ON/OFF.

## SUBSCRIBER SERVICES MENU

The following is a list of all the options available in the Subscriber Main Menu.

- 1** LISTENING TO NEW MESSAGES
- 11** GROUP NEW MESSAGES
- 2** RECORD AND SEND A MESSAGE
- 3** LISTENING TO OLD MESSAGES
- 33** GROUP OLD MESSAGES
- 4** ACCESS MANAGER
- 5** PERSONAL GREETINGS
- 6** MAILBOX ADMINISTRATION
- 8** PAUSE / RESUME
- 0** PLAY MENU OPTIONS
- \*** EXIT TO AUTO ATTENDANT
- #** PERSONAL SERVICES

## 1 or 3

## LISTENING TO OLD OR NEW MESSAGES

- 1** Play / replay the message you just heard.
- 11** Play the previous message.
- 2** Save the message you just heard and listen to the next message.
- 3** Delete the message you just heard and listen to the next message.
- 4** Reply to the message.  
This will allow you to leave a message in the mailbox of the sender (if the sender has a mailbox on this system).
- 5** Return the call directly to the telephone number that left the message.  
This will work for internal and external callers, but Caller ID service is needed to use this feature on an outside call.
- 55** Deliver a fax copy.  
This will allow you to receive attached faxmail document(s). Faxmail documents can be delivered to any fax machine of your choice as long as out calling is authorized. You can also have faxmail messages automatically delivered to the fax machine of your choice.
- 6** Forward the message and saves a copy.  
The subscriber can be selected by dialing their mailbox number (nnn), using the directory service (#) or you may also add comments and leave it as a memo to yourself (##).  
The Send and Copy Service (option 6) allows a user to send copies of a message to multiple recipients easily. A different introduction message may be left for each recipient.
- 7** Rewind the message 5 seconds.
- 77** Change playback volume of the recording. **[Not available on the OS 7030, OS 7100, OS 7200-S or OS IP-UMS]**  
There are two levels of volume during playback. Dialing this code will toggle between the two levels.
- 8** Pause or resume during message playback.
- 9** Fast forward the message 5 seconds.
- 99** Change playback speed of the recording. **[Not available on OS 7030, OS 7100, OS 7200-S or OS IP-UMS]**  
There are two levels of speed during playback. Dialing this code will toggle between the two speeds.

- 0** Play options.  
Pressing this key will play all the menu options available to you from this point.
- 00** Hear the time and date, and sender's information of the message you just heard. Sender information is not available on outside calls.
- #** Move to the next message. This does not Save or Discard the current message - it is retained as new.
- ##** Scan. Plays first 7 seconds of a message then skips to next message. This is similar to the scan button on a radio. It will allow you to find a specific message quickly. To stop scanning press **[1]**.
- \*** Cancel and return to previous menu.

**11** or **33**

## GROUP NEW OR OLD MESSAGES

Messages can be grouped as either Reminders, press **[3]** or Messages from a specific sender, press **[9]**.

Additionally you can press **[#]** and hear a summary of your mailbox contents:

- a) Number of messages
- b) Number of reminders
- c) Number of urgent messages
- d) Number of messages needing a callback
- e) Number of private messages
- f) Number of fax messages

**2**

## RECORD AND SEND A MESSAGE

This option is used to send a message to another subscriber. The steps are simple:

- a) Enter the recipient's mailbox number, or if this is not known enter **[#]** to use the system directory.
- b) Record your message at the tone. After recording the message, you will hear the Send Menu with the following functions:
  - 1** Review
  - 2** Continue Recording

- 3** Discard and Re-Record
- 4** Set Message Attributes (Delivery Options)
- 5** Schedule Future Delivery
- 6** Save and Send then Send a Copy to Someone Else
- #** Save and Send the Recording

## Setting Message Attributes

If after recording a message you select **[4]** you can set up any combination of the following delivery options:

- 1** Urgent Delivery
- 2** Return Receipt Requested
- 3** Request a Call Back
- 4** Private Delivery
- 5** Reply Required
- \*** Exit

## Scheduling Future Delivery

If after recording a message you select **[5]** to schedule future delivery, you will be able to set message attributes and set this message as:

- #** Immediate Delivery
- 1** Next Few Hours
- 2** End of Current Business Day (based on your Availability Schedule)
- 3** Beginning of Next Business Day (based on your Availability Schedule)
- 4** A Coming Day of the Week
- 5** Specific Day / Time
- \*** Exit



# 4

## ACCESS MANAGER

The Access Manager allows the subscriber to set a number of options for when, where and how, and/or if the Samsung Voicemail contacts you when a caller dials your extension number. All of the options are toggled on/off based on their current status when you access them.

**Note: ALL** Access Manager options **MUST** be individually allowed by the System Administrator for each Subscriber. They are:

### 1 Follow Me

Allows the subscriber to enter an alternate location and set how long the new destination (Designated Location) will be active. This number may be an internal or external number. This is useful if you are frequently traveling or changing the number where you can be reached.

When Follow Me is activated, the transfer will be supervised and confirmed. This means that if the call is not answered or if rejected by the Subscriber at the designated location it will be recalled to the Subscriber's mailbox.

### 3 Call Blocking

When this feature is active, callers will not be transferred to your extension, they will hear your 'blocked' greeting (if recorded) and will go directly to your mailbox if they do not select any or are not offered any other options.

### 4 Call Forwarding

Unlike Follow Me where the subscriber wants to take their calls at an alternate location this feature allows the subscriber to pass control of his calls to another Subscriber. The "Forwarded To" Subscriber will now be in control of the caller and the caller will NOT return to originating Subscriber's Mailbox. If the "Forwarded To" Subscriber does not answer the caller it will now follow whatever the "Forwarded To" Subscriber has set up for their call conditions. The Caller will hear "Forwarding to" "{Subscriber Name}" before actually being forwarded.

### 5 Call Screening

If this is turned on, the caller will be asked their name and the Samsung Voicemail will play this name to you before the transfer, giving you an option to accept or reject the call.

### 6 Find Me

Find Me, when enabled, will attempt to locate the subscriber by calling a list of preprogrammed phone numbers. The stored phone numbers are entered in 'Personal Services' [#][2] (if allowed by the Administrator). The stored telephone number list can contain up to 9 preprogrammed telephone numbers. The Find Me feature only use the first five.

### 7 Night Intercept

This feature is dependent on your weekly availability schedule, which is entered in 'Personal Services' [#][3] (if allowed by the Administrator). When Night Intercept is active the Samsung Voicemail will first ring your extension then play your primary, No Answer greeting during the day (when you are available) and will NOT ring your extension but simply play your Night greeting during the night (when you are not available).

**Note:** This does NOT use the Day and Night schedules of the phone system. It is solely controlled by the Subscriber's Availability Schedule.

### 8 Pause / Resume

#### \* Exit from Access Manager

#### 0 Play All Options

#### # Play Access Coverage

This feature is useful for finding out how you current access settings are set. It will also tell you what greetings will play under each of the call conditions you have setup.

# 5

## PERSONAL GREETINGS

The options available in this menu will be determined by your System Administrator, and not all of them may be available to you. In the simplest systems, only a mailbox greeting will be available, additional greetings may be accessible in more complex systems.

Your Personal Greeting will be played every time someone dials your extension and you do not answer.

You may record up to 9 Personal Greetings, and you may assign any one of them to be active. There are several different 'Call Coverage' conditions to which you may assign any of your 9 greetings. The Call Coverage Conditions are: No-Answer, Busy, and Do Not Disturb (or Forwarded All). This will allow different greetings to play depending on the type of call forward that you have set, or the condition of your telephone.

The Call Coverage conditions that you can assign specific greetings to are selected by the following digits:

### **1 Primary/No Answer Greeting**

Used when in your office, away from your desk or during the time period you are scheduled available. If this is the only Personal Greeting you record, it will play for all call coverage conditions.

This option is available only if the Administrator has assigned you the 'Basic Greeting' feature.

Example: "Hi this is John Smith. I'm sorry I am not available to answer your call. If someone else can help you, please enter the extension number now. Or, to leave me a message, press 1."

### **2 Busy Greeting**

Played to a caller when you are already talking to someone on your extension or the telephone at your Designated Location.

This option is available only if the Administrator has assigned you the 'Busy Greeting' feature.

Example: "Hi, this is John Smith. I'm on another line right now. If someone else can help you, please enter the extension number now. Or, to leave a message, press 1."

### **3 Call Blocking Greeting**

Used while Call Blocking is enabled in your Access Manager or if your phone is forwarded ALL or DND.

This option is available only if the Administrator has assigned you the 'Call Blocking' feature.

Example: "Hi, this is John Smith. Sorry I missed your call, but I'm going to be out of the office for the next few hours. If someone else can help you, please enter the extension number now. Or, to leave me a message, press 1."

### **4 Night Greeting**

Used during the time period you are scheduled UNAVAILABLE, usually after business hours during the evening and at night.

This option is available only if the Administrator has assigned you the 'Scheduling' feature.

Example: "Hi, this is John Smith. I've left the office for the evening. If you would like to try someone else, please enter the extension number now. Or, to leave me a message, press 1."

### **5 Call Screening Greeting**

Used while Call Screening is enabled, and you REJECT a caller after listening to the caller's record name.

This option is available only if the Administrator has assigned you the 'Call Screening' feature.

Example: "Hi, this is John Smith. I'm sorry, but I am not available to speak with you at this time. If someone else can help you, please enter the extension number now. Or, to leave me a message, press 1."

### **6 Edit Personal Greetings**

You may also edit/record each one of the greetings (1-9) at any time.

Select a greeting number to edit and follow the instructions to record your greeting. When you are done recording your greeting, you will be able to listen to the greeting you recorded, save the greeting you recorded and return to the previous menu, record the greeting again, or exit without saving the greeting.

Note: If you record only the greeting assigned to the No-Answer Call Coverage Condition, then that greeting will play to callers for all Call Coverage Conditions (No-Answer, Busy, Blocked, Night, and Rejected Caller). In this case, the salutation part of the greeting should be very general.

### **7 Edit Mailbox Greeting**

Used whenever a caller reaches your mailbox or if you have not recorded any of the Call Coverage greetings. The way a caller is transferred to your mailbox greeting directly, is by another subscriber transferring the caller to your mailbox using the VT (VoiceMail Transfer) key.

This option is available only if the Administrator has assigned you the 'Mailbox Greeting Option' feature.

Example: "Hi, this is John Smith. Please leave me a message, I will call you as soon as I can."

Note: This greeting will only play if none of the 5 personal greetings has played to the caller. A common usage for this Greeting is when another Subscriber is talking with a caller and uses the VT key on their phone to transfer the caller directly to your Mailbox.

## MAILBOX ADMINISTRATION

The Mailbox Administration menu is used to turn on and off your pager notification, message alert options and other message control features.

### 1 Message Alert

When this function is activated, the Samsung Voicemail will call any outside or inside telephone number, after each message is left in your voice mailbox.

To hear your message at the remote location when the Samsung Voicemail calls you, after you pick up the telephone and answer you will be instructed that there is a message and to enter your password. Simply enter your password and you will now be logged in.

#### Setting Up Message Alert:

- From the Subscriber Services Menu press **[6]** for Mailbox Administration.
- Press **[1]** for Message Alert.
- There are 4 options available to you:
  - Press **[1]** to toggle message alert on and off.
  - Press **[2]** to set the schedule when you would like to be notified.
  - Press **[3]** to be notified on urgent messages only.
  - Press **[4]** to set the destination phone number.

### 2 Pager Notification

When this function is activated, the Samsung Voicemail will call your beeper service and notify you after each message is left in your voice mailbox.

- From the Subscriber Services Menu press **[6]** for Mailbox Administration.
- Press **[2]** for pager notification.
- There are 4 options available to you:
  - Press **[1]** to toggle pager notification on and off.
  - Press **[2]** to set the schedule when you would like to be paged.
  - Press **[3]** to be notified on urgent messages only.
  - Press **[4]** to set the pager phone number.

### 3 Undelete

When this function is activated, the Samsung Voicemail will allow you to undelete any messages that you have recently deleted (up to the programmed Daily Maintenance Time, which is set to 3 a.m. by Default the following morning).

- From the Subscriber Services Menu press **[6]** for Mailbox Administration.
- Press **[3]** for Deleted Messages.

Deleted voice mail messages are temporarily stored in memory until 3 a.m. the following day. Select this option to recover ("undelete") previously deleted messages, during this period of time.

### 4 Undelivered Retrieval

When this function is activated, the Samsung Voicemail will allow you to recall any messages you have sent that have NOT yet been picked up by the recipient.

- From the Subscriber Services Menu press **[6]** for Mailbox Administration.
- Press **[4]** for Undelivered Messages.

This useful feature will allow you to cancel any messages that have NOT yet been picked up by the recipient.

### 5 Auto Play New Messages

If this option is enabled, after you enter your password correctly any new messages will immediately begin to play. To enable (or if already enabled toggle and disable) this feature:

- From the Subscriber Services Menu press **[6]** for Mailbox Administration.
- Press **[5]** to Set Auto Play of New Messages.

### 6 Auto Play Message Information

If this option is enabled, the date, time and sender's name will be played automatically before each message. If this is disabled, the information must be requested manually by pressing '00'. To enable (or if already enabled toggle and disable) this feature:

- From the Subscriber Services Menu press **[6]** for Mailbox Administration.
- Press **[6]** to Set Auto Play of Message Information.

## MESSAGE BROADCAST

This option will only be available if it has been allowed by the System Administrator.

### Broadcast to All Mailboxes

If you have been designated as a Subscriber Administrator, you may send a message to ALL mailboxes in the system.

- From the Subscriber Services Menu press [6] for Mailbox Administration.
- Press [9] for Broadcast Messages.

This option will only be available if your mailbox has been assigned Subscriber Administration privileges.

## PERSONAL SERVICES

The Personal Administration Menu is used to set your password and record your name. Many of these features must be allowed by the System Administrator.

### 1 Workload Management

Allows you to access to all reminders, both Active and Pending. If authorized you can group your reminders as Commitments, Follow-Ups or Tasks for better organization. The system will flag each reminder as Active or Pending (pending means scheduled for future delivery).

### 2 Stored Numbers

Allows you to enter up to 9 stored phone numbers. The first five of these are used in the 'Find Me' feature, but any of them (1-9) can be easily dialed using only one digit followed by the pound key, to be used by many other features from within your subscriber space. (ie: "Follow Me," "Message Alert," "Pager Alert," and "Direct Call").

### 3 Schedule Availability

Allows you to enter a weekly availability schedule for use with Night Personal Greeting and the Auto Night Intercept feature. Follow the spoken directions

to enter the days of the week and times you are generally available to talk to your callers. All other times you will be considered unavailable.

### 5 Place a Direct Call

Allows you to place a direct call out of the Samsung Voicemail from anywhere. You may either dial the number or dial a single digit 1-5 that corresponds to a stored number ([See Personal Services, 2 - Stored Numbers](#)). This feature must be authorized by the System Administrator and can be limited or opened to internal, local, and long distance calls.

### 7 Personal Administration

This area is used during the initial set up of your Subscriber Settings ([see next section](#)).

## PERSONAL ADMINISTRATION SETTINGS

This menu allows you to make changes to basic setup settings, that are rarely changed. Use these when you initially set up your personal Subscriber settings. You probably will not need to change them after that.

### 1 Setting your Password

- From the Subscriber Services Menu press [#][7][1].
- The current password will be played and you will have the chance to change it.

### 2 Recording your Name

Use this option to record your name. Your recorded name is played in several different situations. It is important to record your name for proper operation of the Samsung Voicemail system.

- From the Subscriber Services Menu press [#][7][2].
- The current name will be played and you will have the chance to change it.

Note: It is possible that if you do not record your name and/or enter your Directory Name (described below), you will not be included in the Dial by Name Directory.

### 3 Entering your Directory Name

Use this option to enter your Directory Name. Your Directory Name is used by callers to find you if they do not know your extension number.

- From the Subscriber Services Menu press [#][7][3].

- The current Directory Name will be played as a string of digits that are equal to your name spelled out on your telephone keypad. Follow the instructions to enter a new name. You will be prompted to enter your last name and then your first name.

This must be done in order for the directory feature to work correctly.

Note: It is possible that if you do not record your name (described above) and/or enter your Directory Name, you will not be included in the Dial by Name Directory.

#### 4 Extended Prompting

Use this option to drastically reduce the number of prompts played in the subscriber interface (mailbox prompts). Change this setting only if you are very familiar with the user operation of the SVMi E-Series.

Note: Remember if you know what digits to press, you can enter them at any time you do not have to wait to be prompted. This feature can be toggled on/off at anytime. Also if it is off you will be prompted within each subscriber menu to press zero for more options. This enables you to still be able to find out what to do if you were to get lost and extended prompting was disabled.

## KEYSET USER FEATURES

The following options are available if you have a display keyset. They require setup by the System Administrator.

### Message Waiting Lights

When new messages are left in your mailbox, the voice mail message light on your keyset will flash. Press this flashing key [**VMMSG**] and follow the prompts to retrieve messages. This key may be pressed at any time to log into your Subscriber Main Menu.

### Answer Machine Emulation

If you have an Answer Machine Emulation key programmed on your keyset, you can use it to monitor calls going to your voice mail, and optionally answer them. The operation of this feature is similar to screening a call on a home answering machine.

Your keyset must be set to forward on no answer to voice mail. After ringing your station the caller will be connected to your voice mail and hear your personal greeting before leaving a message. During this time you will be monitoring the connection between the caller and your voice mail box. At this time you will only be monitoring the call, you can not talk to the other party until you answer. You may pick up the call at any time or ignore it.

To activate this feature press the **AME** button. The associated indicator will be lit steady. Press again to turn off. If this key is pressed while a station is ringing (during forward no answer), the feature will be turned on for the current call only.

While the caller is leaving a message or ringing you may:

- Press [**#**] to immediately put the caller in your voice mailbox and monitor it.
- Press [**\***] to immediately disconnect your station. The caller continues to leave a message normally.
- Pick up the handset and monitor privately.
- Press **ANS / RLS** to answer the call (using the handset or speaker).

### AME Password

If your keyset has **AME Password** (MMC 110) set to **Yes**, you must enter your station password to listen to messages being left. This will prevent unauthorized people from listening to messages being left for you.

If the password option is turned on, while a message is being left, press the flashing **AME** indicator and enter your station password (not your SVMi E-Series password). You will then hear the message being left.

### Call Record

If you have a call record button assigned to your phone, you may press it at any time, to record the conversation in progress. If you have a display keyset, you will also have the soft key options to pause and time the message.

## SHORTCUTS

### Calling

Calling a station that is busy or does not answer you can press [#] to immediately send the call to the called parties mailbox.

### Call Divert to Voicemail

While receiving an incoming (ringing) call, dial [\*] to immediately send the caller to your personal voicemail box. This will override the call forward no answer setting.

### Direct Messaging

[#] + DSS To make it easy to leave messages for others in your office without having to dial their extension number first, keyset users may simply dial [#] plus a mailbox (extension) number and leave a message directly. If you dial a busy extension press [#] to connect directly with the mailbox.

### Self Memo (Reminder)

Pressing [##] will leave a message in your own mailbox. This is useful to remind yourself of things to do now or in the future. Messages can be sent with future delivery so you can have the system call you when items become due.

## INTERACTIVE DISPLAYS

Display keyset users have the added advantage of using the soft keys and displays to play, save, delete, reply, call, forward, rewind, pause, fast forward, change the volume, get message information, or help.

### Viewing Mailbox Contents

If you have new messages, in addition to the Telephone Status Indicator (TSI) you will be able to use the keyset displays and soft keys to communicate with the SVMi E-Series.

## E-MAIL GATEWAY (EMG)

The E-Mail Gateway feature integrates your voice mail box with your email client. No matter what email client software you are using or where you use it, you can send voice mail messages and fax mail messages to your E-Mail inbox.

There are two parts to the E-Mail Gateway; E-Message Delivery and E-Message Notification.

- 1. E-MESSAGE DELIVERY:** Voice mail messages (.wav) and/or fax mail messages (.tiff) are "delivered" to your Inbox with the appropriate attached file.
- 2. E-MESSAGE NOTIFICATION:** You will receive an e-mail, with NO attachments, notifying you that you have a voice and/or fax mail message in your Voice Mail Box.
  - As a subscriber you can use either E-Message Delivery and/or E-Message Notification.
  - As a subscriber you can have multiple e-mail addresses. (a maximum of 5 valid email addresses).
  - E-Message Notification can be set to one e-mail address while E-Message Delivery is set to different e-mail address.

## Functionality

- With either type of EMG, when Caller ID (CID) is provided, the callers telephone number will appear in the subject field of the email along with the date and time stamp of when the voice message was originally recorded in your Voice Mail Box.
- If the caller is also a subscriber on the system and the E-Mail Gateway is set up with a valid "Reply To" address, the Subscriber's name will also appear in the "From" field. Otherwise, the "From" field will display the name of the Samsung voice mail system (SVMi-8E, SVMi-16E, or SVMi-20E) sending the message.
- Client will use their PC's Multi-Media kit (equipped with either speakers and/or a headset) to listen to messages delivered to their e-mail Inbox.

**IMPORTANT NOTE:** If the PC/Laptop/PDA/Smart Phone/etc... is not equipped with hardware and software capable of playing a '.WAV' file then the E-Mail Gateway will not work for them until they add some method to listen to '.WAV' files delivered to their Inbox.

The same applies to Fax Mail messages, if the device the subscriber is using does not support the viewing of '.TIFF' files, then the E-Mail Gateway for Fax Mail will not work for them until they add some method to view .tiff files delivered to their inbox.

- No Synchronization of messages is performed between the Voice Mail Box and the E-mail Inbox.
  - Messages listened to, forwarded, deleted, and/or saved within an e-mail inbox will NOT effect the status of that same new message in the Voice Mail or the MWI (Message Waiting Indicator) associated with that message on the phone.
  - Also messages listened to in the Voice Mail, from a phone, will not change the Unread/Read status of the same message in an e-mail inbox.

- However, the Voice Mail Administrator can adjust parameters per subscriber or group of subscribers that decide how, when, or if to delete the original voice message after it is sent to the E-Mail Server.

- When full synchronization of messages between Voicemail Box and E-mail Inbox is required, ask your Samsung representative about the OfficeServ IP-UMS. This is an Internet Protocol based fully synchronized Unified Messaging System.

## Benefits

- Store and Archive Voice and Fax Mail Messages in visible folders.
- Voice and Fax Mail Messages can now easily be dragged and dropped into folders the same way e-mail messages are organized and saved.
- Voice and Fax Mail Messages are now essentially the same as any other e-mail message.
- Backups and Message Archives can be made when they are made for all other types of e-mail messages.
- Add text notes and comments to use for reference later.
- Some (if not all) e-mail clients will allow you to edit the body of the e-mail to add comments.
- Some will allow you to edit the subject field to help you find a particular message quickly in a large archive of messages.
- Call Back Numbers and Date & Time Stamp are easily displayed in the Subject field.
- Easily forward Voice messages received, to others even if they are not a Voice Mail Subscriber on your system.
- No EMG System or Client Software to load on your Local PC or Network Servers.

Therefore compatible with most:

- E-Mail providers and E-Mail Clients
- PCs, Laptops, PDA, and/or Smartphones

**NOTE:** If you are not sure you have this functionality on your system and you would like to use it, please contact your on Site system administrator to see if it is available.

## PERSONAL SPEED DIAL NUMBERS

CODE	NAME	TELEPHONE NUMBER
00	_____	_____
01	_____	_____
02	_____	_____
03	_____	_____
04	_____	_____
05	_____	_____
06	_____	_____
07	_____	_____
08	_____	_____
09	_____	_____
10	_____	_____
11	_____	_____
12	_____	_____
13	_____	_____
14	_____	_____
15	_____	_____
16	_____	_____
17	_____	_____
18	_____	_____
19	_____	_____
20	_____	_____
21	_____	_____
22	_____	_____
23	_____	_____
24	_____	_____

# PERSONAL SPEED DIAL NUMBERS

CODE	NAME	TELEPHONE NUMBER
25	_____	_____
26	_____	_____
27	_____	_____
28	_____	_____
29	_____	_____
30	_____	_____
31	_____	_____
32	_____	_____
33	_____	_____
34	_____	_____
35	_____	_____
36	_____	_____
37	_____	_____
38	_____	_____
39	_____	_____
40	_____	_____
41	_____	_____
42	_____	_____
43	_____	_____
44	_____	_____
45	_____	_____
46	_____	_____
47	_____	_____
48	_____	_____
49	_____	_____

## FEATURES AND SPECIFICATIONS

### LINE GROUPS

- 9 Local/LCR \_\_\_\_\_
- 800 \_\_\_\_\_
- 801 \_\_\_\_\_
- 802 \_\_\_\_\_

### STATION GROUPS

- 501 \_\_\_\_\_
- 502 \_\_\_\_\_
- 503 \_\_\_\_\_
- 504 \_\_\_\_\_

### PAGING ZONES - DIAL 55 PLUS

- 0 \_\_\_\_\_
- 1 \_\_\_\_\_
- 2 \_\_\_\_\_
- 3 \_\_\_\_\_
- 4 \_\_\_\_\_
- 5 \_\_\_\_\_
- 6 \_\_\_\_\_
- 7 \_\_\_\_\_
- 8 \_\_\_\_\_
- 9 All External Zones
- \*All External Zones and Internal Zone 0

### PROGRAMMED MESSAGES

- 01 In A Meeting
- 02 Out On a Call
- 03 Out To Lunch
- 04 Leave A Message
- 05 Page Me
- 06 Out Of Town
- 07 In Tomorrow
- 08 Return Afternoon
- 09 On Vacation
- 10 Gone Home
- 11 \_\_\_\_\_
- 12 \_\_\_\_\_
- 13 \_\_\_\_\_
- 14 \_\_\_\_\_
- 15 \_\_\_\_\_
- 16 \_\_\_\_\_
- 17 \_\_\_\_\_
- 18 \_\_\_\_\_
- 19 \_\_\_\_\_
- 20 \_\_\_\_\_

### FEATURE ACCESS CODES

- 10 + xxx Pick Up A Parked Call
- 12 + xxx Pick Up A Held Call
- 13 Door Lock Release
- 16 + xxx Speed Dialing
- 17 Save And Redial Number
- 18 New Call (Recall)
- 19 Last Number Redial
- 400 Cancel Do Not Disturb
- 401 Set Do Not Disturb
- 42 + xxx Cancel Message You Left
- 43 Return Message
- 44 Callback
- 45 Busy Station Camp-On
- 46 Conference
- 47 Account Code
- 48 + xx Cancel Programmed MSG
- 49 Send Flash To C.O. or PBX
- 56 Meet Me Answer
- 600 Cancel All Call Forward
- 601 + xxx Set Forward All Calls
- 602 + xxx Set Forward Busy
- 603 + xxx Set Forward No Answer
- 604 + xxx Set Fwd Busy/No Answer
- 605 + xxx Set Forward on DND
- 606 + xxx Set Forward Follow Me
- 65 + xxx Pick Up Ringing Extension
- 66 + xx Pick Up Group
- 67 Universal Answer
- \* Authorization Code





**OfficeServ™ 7000 Series**

**Executive MOBEX  
Telephone User Guide**

**SAMSUNG**

## **Executive MOBEX User Guide**

for  
OfficeServ™ 7000 Series

*March 2011*

Samsung Telecommunications America reserves the right without prior notice to revise information in this guide for any reason. Samsung Telecommunications America also reserves the right without prior notice to make changes in design or components of equipment as engineering and manufacturing may warrant. Samsung Telecommunications America disclaims all liabilities for damages arising from the erroneous interpretation or use of information presented in this guide.

# TABLE OF CONTENTS

<b><u>ABOUT THIS BOOK</u></b> .....	1
-------------------------------------	---

<b><u>THINGS YOU SHOULD KNOW</u></b> .....	2
--	---

<b><u>CONNECTING TO THE SYSTEM</u></b> .....	3-4
--	-----

## **OUTSIDE CALLS**

<u>Making an Outside Call</u> .....	5
-------------------------------------	---

## **INTERCOM CALLS**

<u>Calling Other Stations</u> .....	6
<u>Calling Your System Operator</u> .....	6

## **CALL PROCESSING**

<u>Retrieving Calls on Hold at Another Station</u> .....	7
<u>Transferring Calls</u> .....	7
<u>Transfer with Camp-On</u> .....	7
<u>Setting Up a Conference</u> .....	8
<u>Forwarding Your Calls</u> .....	8-9
<u>Call Pickup</u> .....	9-10

## **DIALING FEATURES**

<u>Speed Dialing</u> .....	11
<u>Programming Personal Speed Dial Numbers</u> .....	11
<u>Last Number Redial</u> .....	11

## **PAGING AND MESSAGING**

<u>Making an Internal Page</u> .....	12
<u>Making an External Page</u> .....	12
<u>All Page</u> .....	12
<u>Meet Me Page/Answer</u> .....	12
<u>Call Park and Page</u> .....	12
<u>Retrieving a Parked Call</u> .....	13

<b><u>PERSONAL SPEED DIAL LIST</u></b> .....	14-15
--	-------

## ABOUT THIS BOOK

This booklet provides instructions for call handling and feature interaction on your Executive MOBEX phone with OfficeServ 7000 Series system.

Please take the time to study this guide and to become familiar with the operation of your Executive MOBEX phone. Keep it handy. You may need to look up instructions for infrequently used features.

Learning to use your Executive MOBEX phone correctly will make everyday telephone communications a breeze.

This book is written based on the factory default settings for the feature access codes. Sometimes, due to programming requirements, these codes may be changed. If you find that a feature code does not work as described in this book, please contact your installation and service company to determine the correct code.

# THINGS YOU SHOULD KNOW

## USER ORIENTATION

Your Executive MOBEX phone interfaces to the OfficeServ 7000 Series system in two ways:

- By logging in after receiving a MOBEX call, or
- If configured, you may dial in to the system and log in to activate the interface.

Both connection methods will be discussed in this booklet.

To get an outside line from the telephone company once connected, dial an access code, usually the digit "9." To call another station in your system, simply dial its extension number. See your system directory list for other access codes and extension numbers.

## C.O. LINES

Lines from the telephone company are "C.O. lines." Calls on these lines are referred to as "outside calls." These C.O. lines are accessed by dialing an access code. For example, dial **9** to get a local outside line or dial **800-8XX** for other line groups. Each line in the system is numbered beginning with 701, and then 702, 703, etc. To get a specific line, dial its three digit line number. If Least Cost Routing (LCR) is programmed into the system, you will only be required to dial **9**.

# CONNECTING TO THE SYSTEM

For the remainder of this booklet instructions will assume that you are connected, logged in, and hearing a system dial tone. There are two ways to connect and log in:

## CONNECTING DURING A MOBEX CALL

When someone calls your office number and rings your Executive MOBEX phone you can initiate the system connection by dialing the MOBEX feature access code, typically \*8. You will hear system dial tone if successful or, if no resources are available, you will be returned to your caller.

## CONNECTING BY CALLING IN TO THE SYSTEM

If the system administrator has allowed it, you may log in to the Executive MOBEX interface by dialing in to the system. Your administrator will provide you with instructions on what number to dial and which login method is used. The two types of login methods are:

- **AUTOMATIC:** Meaning the system will automatically log you in based on the Caller ID of your Executive MOBEX phone, or
- **MANUAL:** Meaning the system requires you to log in based on your extension and passcode.

### To log in manually:

- call in to the number provided by the administrator
- dial your extension number at the tone (or music)
- you will hear a short confirmation tone

# SYSTEM TONES

The system provides several tones to assist you. Some of these tones are already familiar to you.

Intercom Dial Tone—A steady tone that indicates you can begin dialing.



Ringback Tone—Indicates the station you dialed is ringing.



Busy Tone—Indicates the station you dialed is busy.



DND/No More Calls Tone—Fast busy tone indicates the station you dialed is in the Do Not Disturb mode or cannot receive any more calls.



Transfer/Conference Tone—Indicates your call is being held and you can dial another party.



Confirmation Tone—Very short beeps followed by dial tone indicate you have correctly set or canceled a system feature.



Error Tone—A distinctive two level beeping tone indicates you have done something incorrectly. Try again.



# OUTSIDE CALLS

## MAKING AN OUTSIDE CALL

- Dial a C.O. line or line group access code.
- Receive outside dial tone and then dial the telephone number.
- Finish the call by hanging up.

If your system is programmed to require an authorization code before making a call:

- Dial \* and a valid code. You will hear confirmation tone, followed by dial tone.
- Select a C.O. line.

If your system is programmed to require an account code before making a call:

- Dial 47 and a valid code.
- Dial \*8 and receive transfer tone. Select a C.O. line.

For more information see your system administrator.

# INTERCOM CALLS

## CALLING OTHER STATIONS

- Dial the extension number or group number.
- Wait for the party to answer.
- If you hear several brief tone bursts instead of ringback tone, the station you called is set for Voice Announce or Auto Answer.
- Begin speaking immediately after the tone.
- Finish the call by hanging up.

## BUSY STATION CAMP-ON

When you call another station and receive a busy signal but you do not want to wait for a callback:

- Dial **\*8** receive transfer tone and dial **45**.
- The called station will receive off-hook ring or camp-on tone.
- You will hear ringback tone.
- Wait for the called party to answer.

The called station must release its first call or put it on hold before answering your camp-on.

## CALLING YOUR SYSTEM OPERATOR

- Dial **0** to call your system operator or group of operators.
- If you want to call a specific operator, dial that person's extension number.

# CALL PROCESSING

## RETRIEVING CALLS ON HOLD AT ANOTHER STATION

When a line is on hold at any other station:

- Dial **12** plus the extension number of the station that placed the call on hold—**OR**—dial **12** plus the line number if you know what it is.

## TRANSFERRING CALLS

Transfer is used to send any call to another extension in one of two ways. You can perform a screened transfer by informing the other extension who is calling or you can perform a blind transfer without notification.

- While you are speaking on a call, dial **\*8** to receive transfer dial tone and then dial an extension number. Your call is automatically put on transfer hold.
- Hang up when you hear ringing—**OR**—wait for the party to answer and advise the party of the call and then hang up. If the transfer is refused, you will be reconnected to the outside line when the station hangs up or you can **\*8** to return to the outside party.

## TRANSFER WITH CAMP-ON

When you are transferring a call to another station and it is busy, you may camp the call on to this station:

- While you are speaking on a call, **\*8** to receive transfer dial tone and then dial an extension number. Your call is automatically put on transfer hold.
- Hang up when you hear a busy signal. The called party will be alerted that a call is waiting.

## SETTING UP A CONFERENCE

You may conference five parties (you and four other parties) in any combination of outside lines and internal stations in any order.

- While you are engaged in a conversation, dial **\*8**, receive transfer tone and dial **46**. You will receive conference tone.
- Make another call, either intercom or outside.
- After the called party answers, dial **\*8** and receive conference tone.
- Make another call—**OR**—dial **\*8** to join all parties.
- Repeat as necessary.

To drop a party from your conference call:

- Dial **\*8**, receive confirmation tone and dial the extension or line number that is to be dropped.
- Receive conference tone and dial **46** to rejoin the other parties.

NOTE: To leave the conference, hang up. Control will be passed to the first internal station that was added. If there are no internal stations and you wish to leave outside lines connected together in a trunk to trunk conference, follow the instructions to drop a party and use your extension number. When the parties on the outside lines hang up, the lines will release automatically, proceeding disconnect supervision is supplied by the telephone company.

## FORWARDING YOUR CALLS

You may forward your calls to other stations or groups of stations. When they are programmed, Forward All Calls will have priority over Forward Busy and Forward No Answer conditions.

To clear all call forward conditions set at your station dial **600**.

NOTE: It is not necessary to clear call forwarding to change your selection; simply enter a new forward command.

## FORWARD ALL CALLS

To forward all of your calls to another station:

- Dial **601** followed by the destination you want your calls to forward to. This can be an internal (within your system) or external (outside your system such as a cell phone) number.
- Receive confirmation tone and hang up.

To cancel Forward All Calls dial **600—OR—**dial another forward code, e.g., **604**.

## FORWARD BUSY

To forward calls to another station when you are on the phone:

- Dial **602** followed by the destination you want your calls to forward to. This can be an internal (within your system) or external (outside your system such as a cell phone) number.
- Receive confirmation tone and hang up.

To cancel Forward Busy dial **600—OR—**dial another forward code, e.g., **604**.

## FORWARD NO ANSWER

To forward calls to another station when you do not answer:

- Dial **603** followed by the destination you want your call to forward to. This can be an internal (within your system) or external (outside your system such as a cell phone) number.
- Receive confirmation tone and hang up.

To cancel Forward No Answer dial **600—OR—**dial another forward code, e.g., **604**.

## FORWARD NO ANSWER/BUSY

To forward calls to another station when you do not answer or when you are on the phone:

- Dial **604**.
- Receive confirmation tone and hang up.

NOTE: This option will only work if Forward No Answer and Forward Busy destinations are already programmed.

To cancel Forward No Answer/Busy dial **600—OR—**dial another forward code, e.g., **601**.

## STATION CALL PICKUP

To pick up (answer) a call ringing at another station:

- Dial **65** plus the extension number of the ringing phone.

## GROUP CALL PICKUP

To pick up (answer) a call ringing in any pickup group:

- Dial **66** plus the desired group number.

### GROUP NUMBERS

<b>01-10</b>	<b>OfficeServ 7030</b>
<b>01-20</b>	<b>OfficeServ 7100</b> and <b>OfficeServ 7200-S</b>
<b>01-99</b>	<b>OfficeServ 7200</b> and <b>OfficeServ 7400</b>

NOTE: Station and group pickup features cannot be used to answer recalls to a station, only new ringing calls and operator recalls.

## DIALING FEATURES

### SPEED DIALING

You can dial a preprogrammed telephone number stored in the system-wide speed dial list of numbers 500–999 or from your personal list of numbers 00–49.

- Dial **16**.
- Dial the desired speed dial number.
- The telephone number is automatically dialed for you.

NOTE: Your system may be set for 950 system wide numbers. If so the system speed dial access codes are 050~999 and the station speed dial codes are 000~049.

### PROGRAMMING PERSONAL SPEED DIAL NUMBERS

To program personal speed dial numbers:

- Dial **15105** the next available speed dial bin number (e.g. **01**), a trunk or trunk group number and your speed dial digits.
- Hang up.

NOTE: It is much easier to have your System Administrator program these for you.

### LAST NUMBER REDIAL

To redial the last telephone number you have dialed:

- Dial **19**.

NOTE: Redial does not apply to intercom calls.



# PAGING AND MESSAGING

## MAKING AN INTERNAL PAGE

To make an announcement through the keyset speakers in the idle condition:

- Dial **55** plus zone number **0, 1, 2, 3** or **4**.
- After the brief attention tone, make the announcement.

## MAKING AN EXTERNAL PAGE

To make an announcement through the external paging speakers:

- Dial **55** plus zone number **5, 6, 7** or **8—OR—**dial **55** plus **9** to page all external zones.
- After the brief attention tone, make the announcement.

## ALL PAGE

To page all designated keysets in internal zone 0 and all external zones at the same time:

- Dial **55** plus **\***.
- After the brief attention tone, make the announcement.

## MEET ME PAGE/ANSWER

- Make a page by dialing **54** plus any zone and instruct the paged person to dial **56**.
- After completing the page, dial **\*8** and remain off-hook until the paged person dials **56** from any phone. The paged person will be automatically connected with you.

## CALL PARK AND PAGE

When you have an outside call for someone who is not at his/her desk, you can park the call and page the requested party:

- While in conversation, dial **\*8** and dial **55**. The call is automatically parked at your station.
- Dial the desired page zone and make the announcement. Be sure to include your station number, for example, "Mr. Smith, park 201."

## RETRIEVING A PARKED CALL

To retrieve a call that has been parked for you:

- Dial **10** plus the station number that was announced. You will be connected to the parked call.

# PERSONAL SPEED DIAL NUMBERS

CODE	NAME	TELEPHONE NUMBER
00	_____	_____
01	_____	_____
02	_____	_____
03	_____	_____
04	_____	_____
05	_____	_____
06	_____	_____
07	_____	_____
08	_____	_____
09	_____	_____
10	_____	_____
11	_____	_____
12	_____	_____
13	_____	_____
14	_____	_____
15	_____	_____
16	_____	_____
17	_____	_____
18	_____	_____
19	_____	_____
20	_____	_____
21	_____	_____
22	_____	_____
23	_____	_____
24	_____	_____

# PERSONAL SPEED DIAL NUMBERS

CODE	NAME	TELEPHONE NUMBER
25	_____	_____
26	_____	_____
27	_____	_____
28	_____	_____
29	_____	_____
30	_____	_____
31	_____	_____
32	_____	_____
33	_____	_____
34	_____	_____
35	_____	_____
36	_____	_____
37	_____	_____
38	_____	_____
39	_____	_____
40	_____	_____
41	_____	_____
42	_____	_____
43	_____	_____
44	_____	_____
45	_____	_____
46	_____	_____
47	_____	_____
48	_____	_____
49	_____	_____

# FEATURES AND SPECIFICATIONS

## LINE GROUPS

9 Local/LCR  
800 \_\_\_\_\_  
801 \_\_\_\_\_  
802 \_\_\_\_\_

## STATION GROUPS

501 \_\_\_\_\_  
502 \_\_\_\_\_  
503 \_\_\_\_\_  
504 \_\_\_\_\_

## PAGING ZONES - DIAL 55 PLUS

0 All Internal Zones  
1 \_\_\_\_\_  
2 \_\_\_\_\_  
3 \_\_\_\_\_  
4 \_\_\_\_\_  
5 \_\_\_\_\_  
6 \_\_\_\_\_  
7 \_\_\_\_\_  
8 \_\_\_\_\_  
9 All External Zones  
\*All External Zones and Internal Zone 0

## FEATURE ACCESS CODES

10 + xxx Pick Up A Parked Call  
12 + xxx Pick Up A Held Call  
HF-13 Door Lock Release  
16 + xxx Speed Dialing  
17 Save And Redial Number  
18 New Call (Recall)  
19 Last Number Redial  
400 Cancel Do Not Disturb  
401 Set Do Not Disturb  
42 + xxx Cancel Message You Left  
43 Return Message  
HF-44 Callback  
HF-45 Busy Station Camp-On  
HF-46 Conference  
HF-47 Account Code  
48 + xx Cancel Programmed MSG  
HF-49 Send Flash To C.O. or PBX  
56 Meet Me Answer  
600 Cancel All Call Forward  
601 + xxx Set Forward All Calls  
602 + xxx Set Forward Busy  
603 + xxx Set Forward No Answer  
604 + xxx Set Fwd Busy/No Answer  
605 + xxx Set Forward on DND  
606 + xxx Set Forward Follow Me  
65 + xxx Pick Up Ringing Extension  
66 + xx Pick Up Group  
67 Universal Answer  
\* Authorization Code  
\*8 Mobex

Note: HF Indicates Hookflash.

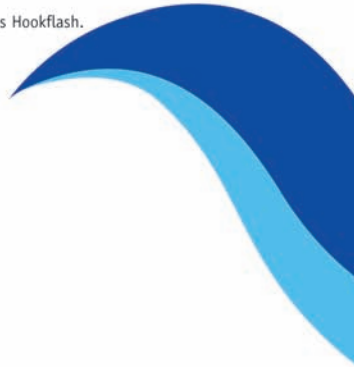

[www.samsung.com/bcs](http://www.samsung.com/bcs)

# ITP-5112L

## IP Keyset User Guide

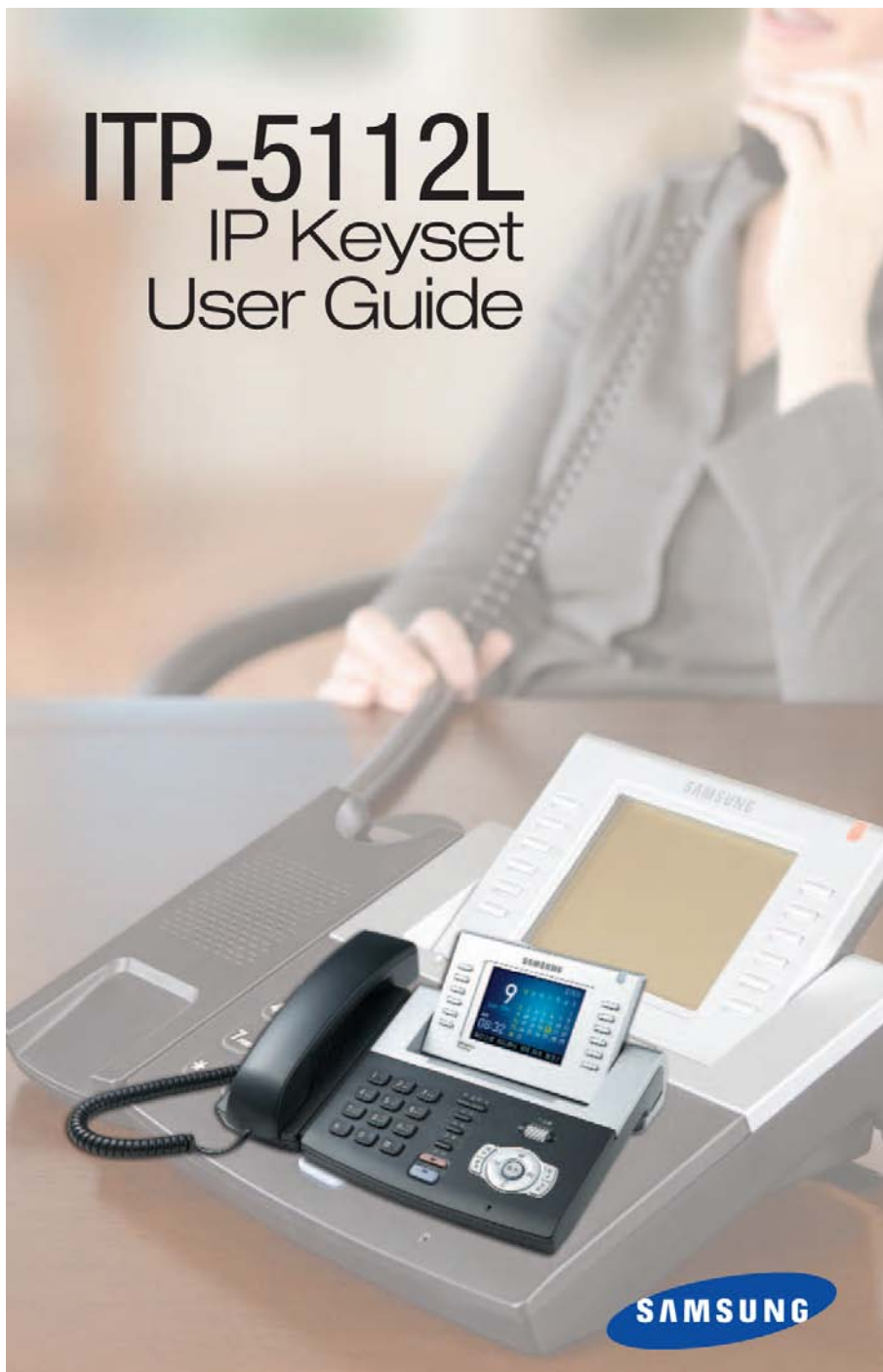

Enterprise IP Solutions

# OfficeServ™

ITP-5112L User Guide

*For OfficeServ™ 100, OfficeServ™ 500,  
OfficeServ™ 7000 Series*

# TABLE OF CONTENTS

<b><u>ABOUT THIS BOOK</u></b> .....	1
<b><u>THINGS YOU SHOULD KNOW</u></b> .....	2–8
<b><u>ASSEMBLING YOUR KEYSET</u></b> .....	9
<b><u>ITP-5112L SETUP</u></b> .....	10
Initializing the ITP-5112L .....	10
IP Setup Menu .....	10
Menu Structure .....	11
Navigating the Menus .....	12
Setting Up Hot Desking (Idle Login) .....	12
Setting the Network Parameters.....	13–15
<b><u>OUTSIDE CALLS</u></b> .....	
Making an Outside Call .....	16
Dialing from the Outgoing / Incoming Menu .....	17
Dialing the Most Recent Outgoing / Incoming Number .....	17
Making Calls from the Call Log .....	17
Answering a Call .....	17
Universal Answer .....	18
Recall Dial Tone .....	18
Sending a Flash .....	18
Busy Line Queuing with Callback .....	18
Canceling Callback.....	19
<b><u>INTERCOM CALLS</u></b> .....	
Calling Other Stations .....	20
Dialing the Most Recent Outgoing / Incoming Number .....	20
Answering Intercom Calls .....	20
Voice Announce Mode .....	20
Auto Answer Mode .....	21
Busy Station Callback .....	21
Busy Station Camp-On .....	21
Calling your System Operator .....	22
<b><u>CALL PROCESSING</u></b> .....	
System Hold .....	23
Exclusive Hold .....	23

Copyright 2007-2009 Samsung Telecommunications America.

All rights reserved. No part of this manual may be reproduced in any form or by any means—graphic, electronic or mechanical, including recording, taping, photocopying or information retrieval systems—without express written permission of the publisher of this material.

Samsung Telecommunications America reserves the right without prior notice to revise information in this guide for any reason. Samsung Telecommunications America also reserves the right without prior notice to make changes in design or components of equipment as engineering and manufacturing may warrant. Samsung Telecommunications America disclaims all liabilities for damages arising from the erroneous interpretation or use of information presented in this guide.

Remote Hold .....	23
Hold Recall .....	24
Consultation Hold .....	24
Retrieving Calls Held at Another Station.....	24
Transferring Calls .....	25
Transfer with Camp-On .....	25
Transfer to Voice Mail .....	26
Call Waiting.....	26
Conference Calls .....	26
Conference Splitting .....	27
Conference Groups .....	27–28
Forwarding Calls .....	28–29
Call Forward Options .....	29
Station Call Pickup.....	30
Group Call Pickup.....	30
My Group Pickup .....	30
Privacy Release .....	30

## **DIALING FEATURES**

Speed Dialing .....	31
Programming Personal Speed Dial Numbers.....	32–33
One Touch Speed Dialing .....	33
Directory Dialing .....	33
Last Number Redial .....	34
Manual Retry with Redial .....	34
Save Number with Redial .....	34
Automatic Redial/Retry .....	35
Pulse to Tone Changeover .....	35
Memo Redialing .....	35

## **PAGING AND MESSAGING**

Making an Internal Page .....	36
Making an External Page.....	36
All Page .....	36
Meet Me Page .....	37
Call Park and Page .....	37
Messages—Set and Cancel .....	38
Returning Messages .....	39
Programmed Messages .....	39

## **CONVENIENCE FEATURES**

Logging In and Out .....	40
Do Not Disturb .....	40
One Time DND .....	40

Mute .....	41
Background Music .....	41
Established Call Pick-Up .....	41
Appointment Reminder/Alarm Clock .....	41–44
Door Phone Calls .....	44
Executive/Secretary Hotline .....	44–45
Group Listening .....	46
Account Codes .....	46
Locking Your Keypad .....	47
Manual Signalling .....	47
Off-Hook Voice Announce .....	48
OHVA Block.....	48
OHVA Reject .....	48
In Group/Out of Group .....	49

## **CUSTOMIZING YOUR KEYSSET**

AME Password .....	50
Auto Camp-On .....	50
Select Ring Tone .....	51
Change Your Passcode .....	51
Set Answer Mode (Intercom) .....	52
Set Answer Mode (CO) .....	52
Automatic Hold.....	52
Headset Operation .....	53
Hot Keypad.....	53
Key Confirmation Tone.....	54
Rejoining a Page.....	54
Ring Preference.....	54
Auto Answer CO Calls .....	55
Display Speed Dial Name .....	55
Caller ID Review All .....	56
Secure OHVA .....	56
Configure Mobile Extensions (MOBEX) .....	57

## **DISPLAY FEATURES**

Directory Information .....	58
Call Log .....	58
Dial by Name .....	59
Call Progress Displays .....	59
Display Number Dialed .....	60
Call Duration Timer .....	60
Auto Timer .....	60
Timer Function .....	60
Viewing Message Indications .....	61
Personal Speed Dial Names .....	61

Station Names .....	61
Managing Key Assignments .....	61
LCR with Clear .....	62
Backspace with LCR.....	62
Text Messaging .....	62–63

<b>CALLER ID</b> .....	64
Selecting your Caller ID Display .....	64
Viewing the Next Caller ID Call.....	64
Saving the Caller ID Number .....	64
Redialing a Saved Caller ID Number .....	64
Storing a Caller ID Number .....	65
Inquire Caller ID Park/Hold Info .....	65
Reviewing Past Caller ID Calls .....	66

<b>APPLICATION PROGRAM MENUS</b> .....	67
PhoneBook .....	67
E-Diary .....	67
Message.....	68
Sound/Screen .....	69
Call Forward .....	69
Setup .....	69
My Phone .....	71

<b>Samsung Voicemail</b> .....	72
Accessing your Mailbox .....	73
SVMi E-Series Subscriber Services Menu Diagram .....	74–75
Getting Started .....	76
Listen to your Messages .....	76
Subscriber Services Menu .....	76
Listening to Old or New Messages .....	77
Group New or Old Messages .....	78
Record and Send a Message .....	78
Access Manager .....	79
Personal Greetings .....	81
Mailbox Administration.....	83
Message Broadcast .....	85
Personal Services .....	86
Personal Administration Settings .....	87
Keypad User Features .....	88
Shortcuts .....	90
Interactive Displays .....	90
E-Mail Gateway (EMG) .....	90–92

<b>PERSONAL SPEED DIAL NUMBERS</b> .....	93–94
--	-------

## ABOUT THIS BOOK

Samsung’s new OfficeServ technology keyset model ITP-5112L is part of the OfficeServ 100, OfficeServ 500, and OfficeServ 7000 Series.

The ITP-5112L IP keyset represents a new concept of Internet phone, in that it uses an IP address to Send/Receive voice and data. For voice communications, the ITP-5112L uses the data network line already in place in most offices and increasing number of homes.

The ITP-5112L IP keysets also incorporate a large LCD color screen, which provides important information for the user, to make using the keyset easier and more convenient.

Please take the time to study this guide and to become familiar with the operation of your keyset. Keep this guide handy, as you may need to look up instructions for infrequently used features.

This book is written based on factory default settings, for the feature access codes. Sometimes, due to programming requirements, these codes may be changed. If you find that a feature code does not work as described in this book, please contact your installation and service company to determine the correct code.

# THINGS YOU SHOULD KNOW

## USER ORIENTATION

The ITP model telephones are called “IP keysets”. The IP keyset incorporates buttons or “keys” that are used to access or activate the many features of your office phone system. The lower five buttons (ten total) that reside on either side of the Large Display screen are programmable buttons. This means they can be programmed for a specific function on your keyset and that same button can be something different on another keyset. See the system manager to get your most frequently used features assigned to your programmable buttons.

The top button on either side of the Large Display Screen scrolls through the various levels of the programmable button display screens.

Lines from the telephone company are “C.O. lines”. Calls on these lines are referred to as “outside calls”. Your system can have individual C.O. line buttons or lines may be assigned to groups. When they are in a group, you access a line by dialing an access code or pressing a route button. For example, dial 9 or press a “LOCAL” button to get a local outside line. If Least Cost Routing is used, pressing the “LCR” button will automatically select a preprogrammed C.O. line according to what digits are dialed. Each line in the system is numbered, beginning with 701, then 702, 703, etc.

Direct Station Selection (DSS) buttons are programmed to ring specific stations. You can press a DSS button instead of dialing the extension number.

The 5112L keyset provides distinctive ring patterns:

- Outside calls have a single ring tone repeated.
- Internal calls have a double ring tone repeated.
- Door phone calls and alarm/appointment reminders have a triple ring tone repeated.

## FULL DUPLEX SPEAKERPHONE

All ITP keysets are speakerphones. Pressing the **SEND** button will answer an incoming call on the speakerphone. Pressing the **END** button will release the call on the speakerphone.

Switching from the handset to the speakerphone is easy. Press the **SPEAKER** button and hang up the handset.

## TERMINAL STATUS INDICATOR

The terminal status indicator light is positioned on the top right corner of the keyset above the display. The terminal status indicator is a tri-colored (red, green, and amber) light that provides greater visibility of your keysets status than the individual button LEDs. The terminal status indicator provides the following indications:

- Busy/Off Hook           Steady Red
- Intercom Ring           Flashing Red
- Outside Call Ring       Flashing Blue
- Recall Ring              Flashing Amber
- Message Waiting        Flashing Red
- Do Not Disturb         Fast Flash Red at 1 Second Intervals

## SELECT BUTTONS

The 5112L keysets incorporate twelve select buttons. These buttons are positioned six on either side of the LCD screen.

The top left and right buttons are used to page up and page down screens.

The remaining five buttons on either side of the display are programmable. There are ten programmable buttons per programmable feature screen, with the exception of the last screen, which has nine programmable buttons. The total programmable buttons per 5112L station is ninety-nine. Any system feature or function can be assigned to these buttons.

## VOLUME CONTROLS

The 5112L keysets use the **UP** and **DOWN** buttons to adjust the ringer volume while the keyset is ringing, the speaker volume while the speakerphone is in use and the handset volume while you are listening. These three levels will be stored in memory until changed. If background music is turned on at your keyset, the volume buttons will also control the level of music. The volume of pages heard through the speaker of a keyset can be adjusted during a page announcement by using the volume buttons. There are 16 levels for each volume setting. The volume of off-hook ring is controlled by a user-programmable setting.



## SCREEN BUTTON

The 5112L incorporates a **SCREEN** button. This button allows you to choose your keyset's idle screen display. The default is **CALENDAR**. The options are **STATION FIXED FEATURE** buttons (two levels), or **STATION PROGRAMMABLE** buttons (ten levels).

NOTE:

From the default **CALENDAR** screen:

- Press the **SCREEN** button once to access the **STATION PROGRAMMABLE BUTTON SCREEN #1**. Press the **DOWN** arrow associated with the top left soft key and you will advance to **STATION PROGRAMMABLE SCREEN #2**. Each additional press of the **DOWN** arrow will advance you through the screens, until you reach **SCREEN #10**. Press the **UP** arrow associated with the top left soft key to return to the previous screen. Each additional press of the **UP** button will move you back towards the main screen.
- Press the **SCREEN** button twice to access the **SOFT MENU SCREEN #1**. Press the **DOWN** arrow associated with the top left soft key and you will advance to **SCREEN #2**.

## CONFERENCE BUTTON

The **CONFERENCE** button allows the user to set up a call with up to five parties (station or trunk).

## TRANSFER BUTTON

**TRANSFER** is used to send any call to another extension in one of two ways. You can do a screened transfer by informing the other extension who is calling or you can do a blind transfer without notification.

## HOLD BUTTON

The **HOLD** button maintains the call at your keyset, while enabling you to call other stations or consult coworkers in confidence.

## SPEAKER BUTTON

The **SPEAKER** button allows you to have a conversation from the keyset without lifting the handset.

## SCROLL BUTTON ASSEMBLY

The scroll button is actually a type of thumbwheel assembly. You may use it to scroll through the station screens. Rolling the **SCROLL BUTTON DOWN** (towards the navigation button) will advance you through the multiple **SOFT MENU** and **STATION PROGRAMMABLE** button screens. Rolling the **SCROLL BUTTON UP** (towards the station display) will bring the cursor back towards the Main Screen. By scrolling up or down, you cause the cursor to move back and forth through the screens in the same manner as the **UP/DOWN** arrows on the top **SELECT BUTTONS** work.

## NAVIGATION BUTTON

The 5112L keysets incorporate a Navigation Button. This button is designed to assist the user in activating and using various station features, more easily. These features include Outgoing Call Log, Incoming Call Log, Speed Number Search, Call Forward Assign and Alarm Assign.

With the **NAVIGATION BUTTON**, the station user is no longer required to enter station level programming to activate these frequently used features. A few button presses and these features are activated.

The **NAVIGATION BUTTON** is divided into separate feature buttons. These buttons are described below.

- **MENU BUTTON:** This button displays the station feature main menu, which is configured in icons, so that the users can easily utilize various settings and helpful functions.
- **SEND BUTTON:** If the station is programmed for Enblock Dial Mode, when dialing an outside telephone number or internal station number, you must press the **SEND** button to initiate the call. This button is also used when reviewing recently received or called numbers and answering incoming calls. The **SEND** button operates as the **ANS** portion of the **ANS/RLS** button. An **ANS/RLS** button may be assigned to the station as a programmable button.
- **ENTER BUTTON:** This button is used to select a menu option, or to save changes made to a menu or submenu option.
- **DIRECTION BUTTON:** The **DIRECTION BUTTON** is the donut shaped ring, which surrounds the **ENTER** button. This button is used to navigate within the menus. There are directional arrows stenciled into this button, which indicate which direction the cursor will be moved.

Note that the **DIRECTION BUTTON** has four icons, at the top, bottom, left and right of the **ENTER** button. **These icons are used to navigate directly to particular programming options from the CALENDAR screen.**

Pressing the top (INFO) icon will take you directly to the **STATUS INFO SCREEN**. The bottom (TONE) icon will take you to the Sound/Screen Menu. The left side (MESSAGE) icon will take you to the Text Message Menu. The right side (PHONE) icon will take you to the PhoneBook Menu.

- **END BUTTON:** This button is used to disconnect a call after a conversation or to move to the initial screen.

The **END** button operates as the **RLS** portion of the **ANS/RLS** button. An ANS/RLS button may be assigned to the station as a programmable button.

- **CANCEL BUTTON:** This button is used to erase any characters or numbers entered by the dial button or to move to the previous screen.

After pressing the **MENU** button, use the direction button to highlight the desired menu icon. For multiple screen options, the **UP/DOWN** arrows at the either side of the top of the LCD may be used to scroll on a per page basis. Press **ENTER** to access that menu. To navigate within the menu, you may scroll to the desired option/function, dial the associated option function number or press the associated select button on either side of the display.

Press the **END** button to exit programming.

## FEATURE ACCESS CODES

This user guide is written based on the default access code for using system features. If the system numbering plan has been changed some of the access codes may not be correct. Your installing company can inform you the correct codes.

## SYSTEM TONES

The system provides several tones to assist you. Some of these tones are already familiar to you.

Intercom Dial Tone—A steady tone that indicates you can begin dialing.

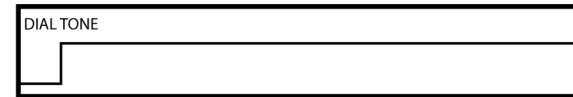

CONTINUOUS

Ringback Tone—Indicates the station you dialed is ringing.

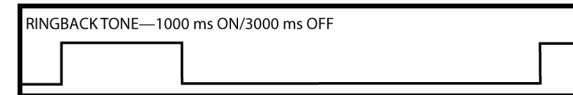

CONTINUOUS

Busy Tone—Indicates the station you dialed is busy.

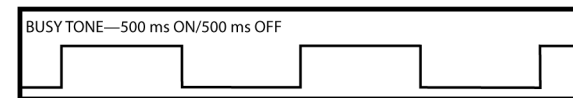

CONTINUOUS

DND/No More Calls Tone—Fast busy tone indicates the station you dialed is in the Do Not Disturb mode or cannot receive any more calls.

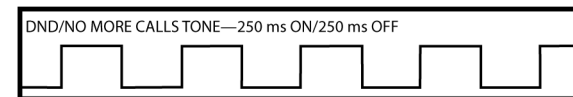

FOR TEN SECONDS

Transfer/Conference Tone—Indicates your call is being held and you can dial another party.

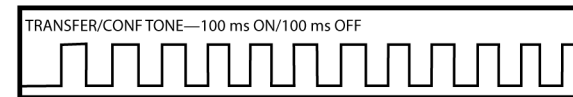

CONTINUOUS

Confirmation Tone—Very short beeps followed by dial tone indicate you have correctly set or canceled a system feature.

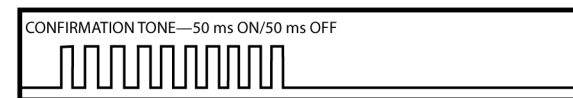

FOR ONE SECOND  
(programmable)

Error Tone—A distinctive two level beeping tone indicates you have done something incorrectly. Try again.

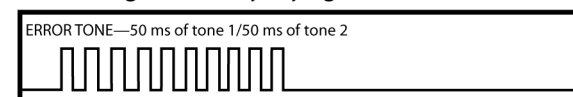

FOR THREE SECONDS

# ITP-5112L KEYSET

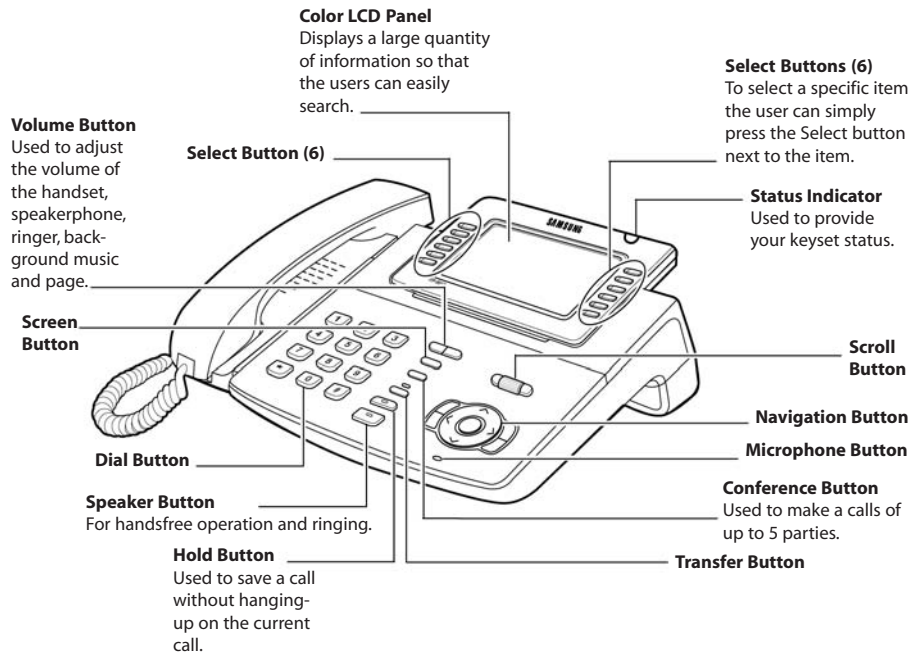

## ASSEMBLING YOUR KEYSET

- Place the keyset face down on a flat surface.
- Insert notched ends of the support bracket into the channels located in the upper section of the bottom panel. Push towards the top of the keyset to lock in.
- Plug the handset cord into the jack marked with the  symbol.
- Route the handset cord out the **RIGHT** side of the keyset as you look at it face down.
- Plug an eight-conductor ethernet cable, from the wall, into the jack marked **LAN** on the back of the keyset. (Connect the ITP keyset to any port on the local network).
- If your ITP will share LAN connection with a PC, plug an eight-conductor ethernet cable, from the PC, into the jack marked **PC** on the back of the keyset.
- Plug the power connector, from the power adapter provided, into the power jack on the back of the keyset. The power adapter is not required if the ITP is connected to a LAN connection that provides power over the ethernet. The ITP-5112L supports the power over ethernet feature when it is connected to a IEEE 802.3af compliant LAN switch or power injector port.

### IMPORTANT NOTES:

- Be careful not to connect the Network LAN cable into the PC connector of the phone.
- To prevent damaging the keyset, only use the Power Adapter that came with the 5112LD keyset.
- This manual assumes that the ITP keysets are connected to a functioning local IP network. The local IP network must be able to communicate with the main processor and MGI channels in the OfficeServ 100, OfficeServ 500, or in the OfficeServ 7000 Series systems over IP. This is assumed regardless of whether the IP keyset is on a local or remote network.
- Before using your ITP-5112L phone, press the MENU button, select Sound/Screen, then select option 8, "Screen Saver". If you choose "User Define", you can set the time period for the Power Save Mode to occur or you can select the interval the Power Save Mode occurs. During Power Save Mode the screen will turn off.

# ITP-5112L SETUP

## INITIALIZING THE ITP-5112L

Initially the ITP-5112L IP keyset will need to be setup to operate within the users network. The Setup Menu is also used to make changes to the keyset, in the event that the system information should change. The option chosen via scroll button will be highlighted.

The station numbers will be automatically set by the OfficeServ 100, the OfficeServ 500, or the OfficeServ 7000 Series systems once the necessary information has been entered into the IP keyset. Enter ID and password of the server, as described below to register the phone.

See your system administrator for specific Network and Server addresses. The addresses necessary to set up the ITP-5112L are:

- IP Address of Station
- Network Gateway Address
- IP Address of System's main processor
- User ID
- Password

## IP SETUP MENU

To get to the **SETUP MODE** unplug the power cord from the ITP. Press and hold the **MENU** button while you plug power back into the phone. Release the **MENU** button when you see the **SETUP SCREEN**. If you have a PoE (Power over Ethernet) connection, the same procedure can be done by unplugging and plugging the Ethernet cable into the phone while pressing and holding the **MENU** button.

Once the **CONFIGURATION MENU** is displayed, you can move to each menu in the Set Up by using the navigation buttons and **[1]-[9]** dial buttons of the ITP-5112L IP phone.

- The **UP** and **DOWN** directions buttons in the navigation button assembly are used to move the highlighted bar up or down to the desired option.
- The **LEFT** and **RIGHT** buttons in the navigation button assembly are used to move the highlighted bar left or right, to the desired option, move to a sub menu and if a menu is at the last line, that menu option will be executed.

Configuration
*1. System Easy Wizard
2. System Information
3. Network Setup
4. Load & Upgrade Setup
5. System Server Setup
6. Factory Reset
7. Reboot

- The **[0]-[9]** dial buttons are used to directly choose a menu, or sub menu options.
- The **[ENTER]** button in the navigation button assembly is used when saving a modification.
- The **[MENU]** button in the navigation button assembly is used to display the IP Setup Main Menu.
- The **[END]** button in the navigation button assembly is used when canceling or editing the modification, or existing programming.
- The **[CANCEL]** button in the navigation button assembly is used to go back to the previous screen or to delete the last digit of a displayed option value.

## MENU STRUCTURE

The IP SETUP MENU is configured as follows:

### 1. SYSTEM EASY WIZARD

This option will guide you through setting up all required parameters for connecting the ITP keyset to your system.

### 2. SYSTEM INFORMATION

1. Version Info: Provides boot rom, software, DSP, and hardware version information.
2. Network Info: Displays network mode, IP address of phone, network, and gateway information.
3. Netmask
4. Gateway

Note that items 2 to 4 are only displayed when setting Manual IP.

### 3. NETWORK SETUP

This menu allows you to individually setup the same parameters found in the Easy Wizard.

### 4. LOAD & UPGRADE SETUP

1. Upgrade TFTP Server: The IP address of the TFTP server containing the ITP software.
2. Upgrade Start: Starts the ITP software upgrade process.

### 5. SYSTEM SERVER SETUP

1. Server IP Address: The main processor's IP address.
2. Server ID: The ID assigned to your ITP (see your phone administrator for this information).
3. Server Pass: The password assigned to your ITP (see your phone administrator for this information).

## 6. FACTORY RESET

This option resets ITP to factory default settings.

## 7. REBOOT

This option reboots the ITP.

# NAVIGATING THE MENUS

When programming within various menu options, information can be entered via the dial pad keys using [0]-[9] and [\*] dial keys, as well as utilizing the navigation button assembly.

The button used for editing and their features are summarized below.

BUTTON	FEATURES
Left and Right .....	To move a cursor (highlighted area) or to erase what is entered.
Enter .....	To save the current setting and end programming.
End.....	To cancel the current programming and return to the Main Menu.
Cancel.....	To move back to the previous screen or delete the last digit of the displayed option value.
[*] .....	To enter [,.] between IP address fields.
[0]-[9] .....	To enter numerical values.

# SETTING UP HOT DESKING (IDLE LOGIN)

Hot Desking allows you to log in and out of your ITP-5112L IP keyset without rebooting.

- From the System Easy Wizard choose option **[5. Idle Mode]**.

Easy Setup
1. Manual IP
2. DHCP
3. PPPoE
4. Plug and Play (DHCP)
5. Idle Mode

- Choose option **[1. Idle Mode Enable/Disable]**.

Idle Mode
1. Idle Mode Enable/Disable

- Enter **1** to allow Hot Desking, Enter **0** to deny Hot Desking.

Idle Mode Setup
Idle Mode: En(1)/Dis(0)

- Press **ENTER**.
- Press **END** twice.

# SETTING THE NETWORK PARAMETERS

Utilize the following programming steps to program the ITP-5112L IP keyset to operate within the users network.

## System Easy Wizard

By selecting this option, the System Easy Wizard can guide you through setting up your network parameters. If you want to set up these parameters individually, follow the instructions below.

## Network Parameter Setup

From the Configuration Main Menu, select **[3. Network Setup]** to set or modify the network parameters. The LCD will display the **Network Setup** screen.

Network Setup
1. Manual IP
2. DHCP
3. PPPoE

- If **[1. Manual IP]** is selected, the user must enter the IP address, subnet mask, and gateway value for the customer network that the 5112L resides on.
- If **[2. DHCP]** is selected, the IP address, subnet mask, and gateway value will be set to the default values automatically. (Choose this option only if a DHCP server is available on the local network).
- [3.PPPoE]** (Point to Point Power over Ethernet): This option is selected in some cases when connecting directly to ISP (Internet Service Provider) equipment without going through a local LAN. If so, you must enter the username/password assigned to you by the ISP to authenticate your internet connection.

## Setting IP Manually

If **[1. Manual IP]** is selected the **Network Setup** sub menu will be displayed.

Network Setup
1. IP
2. Subnet
3. Gateway

The user directly enters the IP address, subnet mask, and gateway, address as follows:

- If the **[1. IP]** menu is selected, the LCD will display the following message and the user can enter the ITP's address.

IP Address
xxx. xxx. xxx. xxx

Check if there is any currently saved IP address of the phone on the LCD. If the IP address has not been set, the LCD displays nothing. The user can enter the IP address using [0]-[9] dial buttons and [\*] button can save that IP address by pressing the [Enter] button of navigation button assembly.

- If the **[2. Subnet]** menu is selected, the user can enter a new Netmask IP address.

Subnet  
xxx. xxx. xxx. xxx

Check if there is any currently saved subnet mask address of the phone on the LCD. If the subnet mask address has not been set, the display will show nothing. Press any dial buttons from [0]-[9] and [\*] button to enter the subnet mask IP address and then save that subnet mask IP address by pressing the [Enter] button of navigation button assembly.

- If the **[3. Gateway]** menu is selected the user can enter a new gateway address.

Gateway  
xxx. xxx. xxx. xxx

The user can check if there is any gateway IP address of the phone that is currently saved on the LCD. If the gateway IP address has not been set, the LCD will show nothing. Use any dial buttons from [0]-[9] and [\*] button to enter the gateway IP address and save it by pressing the [Enter] button of navigation buttons.

NOTE: If DHCP mode is selected, the IP address, Netmask, and Gateway will not be displayed on the LCD.

## Load and Upgrade Set/Modify

The fourth item **[4. Load & Upgrade Setup]** sets or modifies the IP phone's software version. Use extreme caution when upgrading the keyset.

Select the **[4. Load & Upgrade]** item. The screen below is displayed.

1. TFTP Server Setup  
2. Upgrade Start

- **[1. TFTP Server Setup]:** This option is used to enter the IP address of the TFTP Server which hosts the ITP software.
- **[2. Upgrade Start]:** When you select this option, the software from the TFTP server will be pushed to the ITP phone.

## Registering and Authenticating the ITP to your System

The fifth item **[5. System Server Setup]** sets or modifies settings related to the registering the ITP to the main processor. Select the **[5. System Server Setup]**. The screen below will be displayed.

1. System Server  
2. System ID  
3. System Password

You can set/modify the IP address of the main processor at the [1. System Server] item. The screen below is displayed when you enter the item. The server IP is the IP address of the main processor.

Server IP Address  
xxx. xxx. xxx. xxx

You can confirm the current IP address of the authentication server at the LCD panel. The address is left blank if it is not set. Use the dial buttons from [0]-[9], and [\*] to set the IP address and press the **[ENTER]** button among the navigation buttons to save and exit.

Next select the **[2. System ID]** item and the screen below will be displayed.

Phone ID  
xxxx

You must input the ID assigned to your ITP phone. See your phone system administrator to get this value. Press the **[ENTER]** button to save and exit.

Finally, select the [3. System Password] item and the screen below will be displayed.

Phone Password  
xxxx

You must input the password associated with your ID. See your phone system administrator to get this value. Press the **[ENTER]** button to save and exit.

## Completion of Settings

From the Main Menu verify settings at the second item **[2. System Information]** after setting all of the above items. Select the seventh item **[7. Reboot]** to save all modified settings and reboot the ITP-5112L phone.

# OUTSIDE CALLS

**Note:** When making calls, internal or outside calls, in order to access the programmable button screens, press the **SCREEN** button. Then you can utilize either the **SCROLL** button or the **UP/DOWN** arrow (select) buttons on the display.

## MAKING AN OUTSIDE CALL

**IMPORTANT:** Put phone in **OVERLAP MODE:**

- Press the **MENU** button.
- Select **SETUP** and then select **DIAL MODE**.
- Change it to **OVERLAP**. If your phone is not in **OVERLAP** mode you must always press the **SEND** button after dialing the digits to send the call.
- Lift the handset and press an idle outside line button, line group button or dial a line access code to receive dial tone—**OR**—press an idle outside line button, line group button or dial a line access code to receive dial tone through the speaker—**OR**—lift the handset and dial the Trunk Group access code or simply start dialing.
- Dial the telephone number or the Intercom number.
- Finish the call by replacing the handset. To disconnect a speakerphone call, press the **END** button.

NOTES:

1. You will receive No More Calls tone when you attempt to make a call and there is no button available for that line.
2. If Least Cost Routing is enabled on your phone system, this button may be labeled **LCR** or accessed by dialing an access code (usually 9).
3. If your system is programmed to require an authorization code before making a call, dial **\*** plus a valid code before selecting a C.O. line.
4. If your system is programmed to require an account code before making a call, press the **ACCT** button or dial **47** plus a valid bin number, press the **ACCT** button again, or **\***, and then select a C.O. line.

For more information on authorization and account codes, see your system administrator.

**NOTE:** If the Hot Keypad feature has been turned off, you must first lift the handset or press the **SPEAKER** button before dialing.

## DIALING FROM THE OUTGOING / INCOMING MENU

- From the station idle screen, press the **MENU** button and select **PHONE-BOOK**.
- Select **OUTGOING CALLS** or **INCOMING CALLS** from the submenu. These menus will store the last thirty calls made to and from the station.
- Press the select button on the display, associated with the number to redial or use the **DIRECTION** or **SCROLL** button to move the cursor to the desired number. Press the **ENTER** button to display the detailed information of the number.
- Press the **SEND** button to dial the number or press **ENTER** again.

## DIALING THE MOST RECENT OUTGOING / INCOMING NUMBER

- Press the **SEND** button. The most recent call (Internal or External) to or from the station will be displayed.
- Continue to press the **SEND** button and the system will automatically dial the number for you.

## MAKING CALLS FROM THE CALL LOG

The Station Call Log displays the last outgoing station, and incoming trunk calls. The total number of calls that can be displayed is 60. You may redial any of these calls from the Call Log.

- Press the **SEND** button to display the first page of the **CALL LOG**.
- Use the **SCROLL** button or the **DIRECTION** button to navigate to the desired number. Use the **UP** and **DOWN** arrows, associated with the top left and right soft keys to advance and return through the **CALL LOG** Screens.
- When the desired number is highlighted, press the **SEND** button.
- The number will be automatically dialed.

## ANSWERING A CALL

- Lift the handset and you are automatically connected to the ringing call. [See Ring Preference under Customizing Your Keypad](#)—**OR**—press the **SEND** button to automatically answer on the speakerphone.
- While a call is ringing in, the display will indicate the type of call coming in (station number and name, trunk number and name, etc.)

NOTES:

1. If a call is flashing at your keyset but not ringing, you must press the flashing button to answer.

2. While a call is ringing in, press the **SCREEN** button to display the programmable button screen. This will enable you to view and invoke any of the station features that you may wish.

## UNIVERSAL ANSWER

Outside lines may be programmed to ring a general alerting device. To answer calls ringing this device, dial **67—OR—**press the **UA** button. This device can operate in any one of the six different ring plans.

NOTE: If the Hot Keypad feature has been turned off, you must first lift the handset or press the **SPEAKER** button before dialing.

## RECALL DIAL TONE

- Press the **NEW** button to disconnect your existing call, wait for dial tone and then make a new call on the same line.

NOTE: If this button does not appear on your keyset, the **FLASH** button may be programmed to recall dial tone.

## SENDING A FLASH

While on an outside call, press the **FLASH** button to send a flash to the telephone company. This is required for some custom calling features or CENTREX use.

NOTE: Flash is not available on an ISDN circuit.

## BUSY LINE QUEUING WITH CALLBACK

If you receive a busy signal when you are selecting an outside line, this means that the line or group of lines is busy.

- Press the **CALLBACK** button, if programmed, or dial **44**, you will hear confirmation tone.
- Press the **END** button.
- When the line becomes free, the system will call you back.
- Lift the handset or press the **SEND** button to answer, wait for dial tone and dial the telephone number or speed dial number again.

NOTES:

1. A callback will be canceled if not answered within 30 seconds. If you have set a callback, the cursor associated with the **CALLBACK** button will be solid black.
2. If the Hot Keypad feature has been turned off, you must first lift the handset or press the **SPEAKER** button before dialing.

## CANCELING CALLBACK

A callback will be canceled if not answered within 30 seconds. If you have set a callback, the cursor associated with the **CALLBACK** button, will be solid black.

To cancel a callback:

- Press the **CALLBACK** button, if programmed, or dial **44**. The display will show the callback details and an option to **CLEAR** the callback.
- Press the **CLEAR** button, or press the **HOLD** button. This will cancel the last set callback and display the next set callback, also with the option to **CLEAR**. This process is repeated until all callbacks are cleared from memory.

NOTE: If the Hot Keypad feature is turned off, you must first lift the handset or press the **SPEAKER** button before dialing.



# INTERCOM CALLS

## CALLING OTHER STATIONS

- Dial the extension number or group number.
- Wait for the party to answer. If you hear a brief tone burst instead of ringback tone, the station you called is set for Voice Announce or Auto Answer. Begin speaking immediately after the tone.
- Finish the call by replacing the handset or pressing the **END** button.

### NOTES:

1. If you have a **DSS** button assigned to an extension or station group, you may press this button instead of dialing the number.
2. If the Hot Keypad feature has been turned off, you must first lift the handset or press the **SPEAKER** button before you begin dialing.

## DIALING THE MOST RECENT OUTGOING / INCOMING NUMBER

- Press the **SEND** button. The most recent call (Internal or External to system) to or from the station will be displayed.
- Continue to press the **SEND** button and the system will automatically dial the number for you.

## ANSWERING INTERCOM CALLS

- When your keyset rings, simply lift the handset—**OR**—press the **SEND** button to be connected to the calling station.
- Finished the call by replacing the handset or pressing the **END** button.

[See Ringing Preference under Customizing Your Keyset.](#)

## VOICE ANNOUNCE MODE

When another station calls you, your keyset will sound a brief attention tone and you will hear the caller's announcement.

- Press the **SEND** button to turn on the microphone and speak handsfree—**OR**—lift the handset to reply.
- To finish the call, replace the handset or press the **END** button.

NOTE: In order for C.O. calls to be answered handsfree, AUTO ANS CO must be set to ON.

## AUTO ANSWER MODE

When another station calls you, your keyset will sound a brief attention tone and then automatically answer the call.

- Your microphone and speaker are turned on and you can speak handsfree. For privacy, use the handset.
- To finish the call, replace the handset or press the **END** button.

NOTE: In order for C.O. calls to be answered handsfree, AUTO ANS CO must be set to ON.

## BUSY STATION CALLBACK

When you call another station and receive a busy signal:

- Press the **CALLBACK** button, if programmed, or dial **44**.
- When the busy station becomes free, your keyset will ring.
- Lift the handset or press the **SEND** button to call the now idle station.

### NOTES:

1. A callback will be canceled if not answered within 30 seconds. If you have set a callback, the cursor associated with the **CALLBACK** button, will be solid black.
2. If the Hot Keypad feature has been turned off, you must first lift the handset or press the **SPEAKER** or **SEND** button before dialing.

## BUSY STATION CAMP-ON

When you call another station and receive a busy signal but you do not want to wait for a callback:

### MANUAL CAMP-ON

- Press the **CAMP** button or dial **45**.
- The called station will receive off-hook ring tone repeated every few seconds and the cursor associated with the first available **CALL** button will flash black to indicate your call is waiting.
- Wait for the called party to answer.
- The called station must release its first call or place it on hold before answering your camp-on.

### NOTES:

1. If you receive No More Calls tone, that station has no available button to accept your call. Hang up or leave a message.

2. If the Hot Keypad feature has been turned off, you must first lift the handset or press the **SPEAKER** button before dialing.

### AUTO CAMP-ON

When you want to automatically camp on to a busy station without pressing the camp on button every time you call a busy station, you can set your phone for auto camp-on.

- With the handset on-hook, press **TRANSFER** and then dial **110**.
- Dial **081** to turn **ON** auto camp-on or **080** to turn it **OFF**.
- Press **TRANSFER** to store your selection.

#### From the LCD:

- Press the **MENU** button.
- Scroll to **CONFIG** option and press **ENTER**.
- Scroll to **STATION ON/OFF** and press **ENTER**—**OR**—you may dial **0** and immediately enter the option.
- Scroll to **AUTO CAMPON** option. Press **ENTER** to change status.
- Press **CANCEL** to return to main configuration screen—**OR**—press **END** to return to idle screen.

## CALLING YOUR SYSTEM OPERATOR

- Dial **0** and press **SEND** button to call your system operator or group of operators.
- If you want to call a specific operator, dial that person's extension number.

NOTE: If the Hot keypad feature has been turned off, you must first lift the handset or press the **SPEAKER** button before you begin dialing.

## CALL PROCESSING

### SYSTEM HOLD

When you are connected to any call, press **HOLD**. The call will flash at the keyset. If this call appears on a line button at other keysets, it will flash at those keysets also.

- To take the caller off hold, press that button and the flashing LED will go steady again. Resume the conversation—**OR**—press the **HOLD** button. The flashing LED will go steady again and you will be connected to the call again. Resume the conversation.

NOTE: While on a call, pressing a line button, route button or flashing **CALL** button will automatically put your first call on hold and connect you to the new call. [See Automatic Hold under Customizing Your Keypad.](#)

### EXCLUSIVE HOLD

To place an outside call on hold at your phone so that other users cannot get it:

- Press the **HOLD** button twice. The call will flash on your keyset and this line will show a steady indication on other keysets.
- To retrieve the call, press the flashing line button or press the **HOLD** button a third time.

NOTE: Intercom calls will always be placed on exclusive hold.

### REMOTE HOLD

When you wish to place a call on hold at another station.

- Press **TRANSFER** and dial the station number (or press the appropriate **DSS** button)
- Press the **HOLD** button. This will place the call on system hold on an available **CALL** button or Line button at the remote station and return you to dial tone.

NOTES:

1. If the destination station does not have any free **CALL** buttons or line buttons you will hear No More Calls tone and must return to the other party by pressing the **TRANSFER** button (or the **RETURN** soft key in the display).
2. Intercom calls cannot be put on remote hold.

## HOLD RECALL

If you leave a call on hold longer than the hold timer, it will recall your station. The button that the call appears on will have a slow flashing indicator.

- When your phone rings, lift the handset or press the **SEND** button to answer the recall.
- If you do not answer this recall within a pre-programmed period of time, it will go to the system operator.

## CONSULTATION HOLD

When you are talking on an outside line and it is necessary to consult with another extension:

- Press the **TRANSFER** button; you will receive transfer dial tone. Your call is placed on transfer hold.
- Dial the extension number.
- Consult with the internal party.
- Press **TRANSFER** to return to the outside party or hang up to transfer the call.

NOTE: Repeatedly pressing the **TRANSFER** button will toggle between the outside party and internal extension. If necessary you may disconnect either one of the parties by pressing the **DROP** button.

## RETRIEVING CALLS HELD AT ANOTHER STATION

When a line is on hold and it appears on your keyset, press the **LINE** button with the flashing indicator.

When a line is on hold and it does not appear on your keyset, dial **12** plus the line number or the extension number of the station that placed the call on hold.

NOTE: If the Hot Keypad feature has been turned off, you must first lift the handset or press the **SPEAKER** button before you begin dialing.

## TRANSFERRING CALLS

Transfer is used to send any calls to another extension in one of two ways. You can do a screened transfer by informing the other extension who is calling or you can do a blind transfer without notification.

- While on a call, press the **TRANSFER** button and dial an extension number or group number. Your call is automatically put on transfer hold—**OR**—press a **DSS** button or station group button. Your call is automatically put on transfer hold.
- Hang up when you hear ringing (this is an unscreened or blind transfer)—**OR**—wait for the called party to answer and advise him/her of the call and hang up. If the transfer is refused, you will be reconnected to the outside line when the called station hangs up or you can press **TRANSFER** to return to the outside party.
- If you wish to send the call to another extension without waiting for the first station to hang up, simply press another **DSS** button—**OR**—press the **CALL** button or C.O. line button to return to the outside party and begin the transfer process again.
- When you are transferring a call to a keyset set for Voice Announce or Auto Answer, the transferred call will always ring.

NOTES:

1. After the inside party answers, you may alternate back and forth between the parties by pressing the **TRANSFER** button.
2. If you receive No More Calls tone, that station has no button available to receive another call. Press **TRANSFER** to return to the other party.
3. You cannot transfer an Intercom call by pressing a **DSS** button. You must press the **TRANSFER** button and dial the destination extension number.

## TRANSFER WITH CAMP-ON

When you are transferring a call to another station and you receive a busy signal, you may camp the call on to this station. Simply hang up when you hear the busy signal. The called party will be alerted that a call is waiting for them.

NOTE: If you receive No More Calls tone, that station has no button available to receive another call. Press **TRANSFER** to return to the outside caller.

## TRANSFER TO VOICE MAIL

This feature is used to send a call directly to a voice mailbox. Your keyset must have a correctly programmed **VT** button to accomplish this. To transfer a call directly to a voice mailbox:

- While on a call, press the **VT** button and dial the mailbox number.
- Hang up when dialing is completed.

## CALL WAITING

If an outside call has been camped-on to your phone or another station has camped-on to you:

- You will hear a tone in the earpiece and the call that is waiting for you (camped-on) will flash. In addition the bottom line of the display will indicate the number of the station or trunk party camped-on.
- Press the flashing button to answer; your other call will go on hold automatically if your station has the Automatic Hold feature set. If not, you must press **HOLD** and then the flashing button—**OR**—finish the first call and hang up; the waiting call will ring.
- Lift the handset or press the **SEND** button to answer.

NOTE: Intercom calls will not go on Automatic Hold. When using the speakerphone the camp-on tone will come through the speaker.

## CONFERENCE CALLS

You may conference up to five parties (you and four others) in any combination of outside lines and internal stations in any order.

- While engaged in a conversation, press the **CONFERENCE** button and receive conference tone.
- Make another call, either intercom or outside, press the **CONFERENCE** button and receive conference tone.
- Make another call or press the **CONFERENCE** button to join all parties.
- Repeat the last step until all parties are added.

NOTE: When attempting to add another party to the conference and you are not able to reach the desired person, hang up. Simply press the **CONFERENCE** button again to return to your previous conversation.

### To drop a party from your conference call:

- Press **CONFERENCE** and dial the extension or line number that is to be dropped.
- Press **CONFERENCE** again to reestablish the conference.

NOTE: To leave the conference, hang up. Control is passed to the next internal station. If there are no internal stations and you wish to leave outside lines connected together in a trunk to trunk conference, press the **CONFERENCE** button plus the **CALL** button that the call appears on or follow the instructions to drop a party and use your extension number. When they hang up, the lines will release automatically. Press **CONFERENCE** to rejoin a trunk to trunk conference.

## CONFERENCE SPLITTING

If you are the controlling party of a conference and your keyset has the Auto Hold feature turned on ([See Customizing Your Keyset](#)) and all of the outside lines involved in the conference appear as buttons on your keyset, you can split the conference into separate calls as follows:

- Press any one of the outside line buttons. That outside line indicator will remain steady to indicate you are still connected to it. All other outside lines in the conference will be placed on system hold at your keyset. All intercom callers in the conference will be disconnected. You may now speak with each caller privately and transfer them as usual, or reestablish another conference.

## CONFERENCE GROUPS

Users can create up to six Conference Groups with five members each (including yourself). They can then call all members or only selected members of this group at the same time. As each member answers, their status is indicated in the display. Depending whether the member is either IN the conference or OUT of the conference they can be dropped or called with a single button press. Each Conference Group can be programmed with a name for easy identification.

### Creating a Conference Group

- From the idle condition press the **CONFERENCE** button.
- Press the **MENU** button, then select **ADD** option.
- The Group Name Window appears. Enter up to a 20 character name using the dial pad keys. Use the navigation key to move the cursor left or right while entering characters.
- Press the **DOWN** button on the **NAVIGATION DISC** to move the cursor to the first entry "NUM01" and begin entering the phone number of the first member.
- Enter **9** plus the outside telephone number or enter an internal extension number. Repeat the process until all members are entered in the Conference Group. Use **CANCEL** to erase digits as needed.
- Press **ENTER** to **SAVE** this conference group.
- Press **END** to return phone to idle condition.

## Using Conference Groups

- From the idle condition press the **CONFERENCE** button.
- Select the Conference Group by pressing the corresponding soft key on the left.
- Press **SEND** to call all members of the group – OR – press the **ENTER** key to deselect one or more members, then press **SEND**. As each member answers, their status indicator on the left will change from an X to a circle.
- Once you press the **SEND** button to initiate the conference call you can hang up any member by selecting the member by pressing the **MENU** button and selecting “SENDING CANCEL.” This action will drop the selected member.
- When the conference call is finished, place the handset in the cradle or press the **SPEAKER** key to hang up.

Note: The originating station is the Supervisor of the conference. When this station hangs up, all the conference group members are disconnected. When you want to hang up but keep the other members in the conference, press the **MENU** button, the select **SUPERVISOR**, then cursor to another internal station, then press **ENTER** and hang up. Control of the conference is passed to this station. You are free to go about your business.

## FORWARDING CALLS

This option allows for one button Call Forward setting. You may forward your calls to another station, station group or external destination.

Call forwarding may be set in several different manners:

1. From the dial pad, dial 60 plus the extender (see below) that corresponds with the type of forwarding desired, followed by the station number to forward to.
  - 60 + 0 **Call Forward Cancel.** Cancels all call forwarding from the station.
  - 60 + 1 **Call Forward All Calls.** Forwards all calls under any condition.
  - 60 + 2 **Call Forward Busy.** Forward calls to another station when you are on the phone.
  - 60 + 3 **Call Forward No Answer.** Forward calls to another station when you don't answer.
  - 60 + 4 **Call Forward Busy/No Answer.** Sets both Forward Busy and Forward No Answer.
  - 60 + 5 **Call Forward DND.** Forwards calls when you activate DND.
  - 60 + 6 **Call Forward Follow Me.** Forward calls to the station where you currently are.

2. From the LCD:

- Press the **MENU** button, scroll to the **CALL FORWARD** icon, press **ENTER**.
- Scroll to the desired Forward Option. Press **ENTER** button.
- You will be prompted to enter the Forward Destination. Enter it and press **ENTER**.

NOTE: Once call forwarding has been initially set, for subsequent settings, you may scroll to the desired forward type and press **ENTER** to forward to that same destination. You may also press the **SELECT** button associated with the desired forward type, as opposed to scrolling to it.

3. From the Station Feature Button:

- Each of the forward types may be assigned its own feature button. Pressing the desired feature button will set forwarding to the last destination.

NOTES:

1. If the Hot Keypad feature has been turned off, you must first lift the handset or press the **SPEAKER** button before you begin dialing.
2. The station that receives a Forward All call can transfer the call to the forwarded station. This is useful when you are expecting an important call but you do not wish to be disturbed by other calls.
3. When a station user places his/her keyset in Forward All mode and he/she does not have a **FORWARD ALL** button, the **TRANSFER** button will light to indicate Forward All has been set and calls to this station have been transferred elsewhere.

## CALL FORWARD OPTIONS

A display keyset may review or change call forward options and destinations. Call forward access can be done via the keypad or by accessing the keyset display features. To review or change call forward options:

- Press **TRANSFER 102**.
- Dial **0-6** to select the forward type (e.g., 1) **OR** Press **UP** or **DOWN** to select the forward type Press the right soft key to move the cursor
- Dial the destination number (e.g., **202**) **OR** Press **UP** or **DOWN** to select the destination and press the right soft key to move the cursor
- Dial **1** to set **OR** press **UP** or **DOWN** to select **YES** or **NO** and press **TRANSFER** to store and exit.

## STATION CALL PICKUP

To pick up (answer) a call ringing at another station, lift the handset and dial **65** plus the extension number of the ringing phone. If you have a DP key assigned with a station number, you only need to press this DP key with the flashing light to answer this ringing station. NOTE: If the Hot Keypad feature has been turned off, you must first lift the handset or press the **SPEAKER** button before you begin dialing.

## GROUP CALL PICKUP

To pick up (answer) a call ringing in any pickup group, lift the handset and dial **66** plus the desired group number (**01-10** on the **OfficeServ 7030**, **01-20** on the **OfficeServ 100** and **OfficeServ 7200-S**, **01-99** on the **OfficeServ 500 M**, and **01-99** on the **OfficeServ 500 L and OfficeServ 7000 Series**) or press the flashing **GROUP PICKUP** button if available.

### NOTES:

1. A group pickup button can have an extender for a specific pickup group.
2. If the Hot Keypad feature has been turned off, you must first lift the handset or press the **SPEAKER** button before dialing the access code.

## MY GROUP PICKUP

If desired, a new access code can be assigned to pickup ringing calls in the same pickup group as you are in. Like "66" above except you do not need to dial the desired group number. See your installation company for the assigned access code. MY GROUP PICKUP: \_\_\_\_\_.

## PRIVACY RELEASE

This feature will allow another station to join in our conversation by releasing privacy on the C.O. from your phone.

**To Release Privacy:** While you are talking on a C.O. line and you wish to have other internal parties (or up to three) join the conversation.

- Press the **PRB** button (the **PRB** indicator will be steady). Inform the other party that he/she may now join the conversation.

After the other party (or parties) has joined the conversation and you wish to return privacy to the line so that no one else can join the conversation, press the **PRB** button a second time, the **PRB** button LED will be off.

**To Join a Non-Private Conversation:** When someone has informed you that you can join a conversation:

- Press the **C.O. line** button that he/she has indicated OR
- Dial the **C.O. line number** that he/she has indicated.

## DIALING FEATURES

All "DIALING FEATURES" instructions are written to support Overlap Dialing mode. This is the technical name for dialing from a telephone as it has been for many years. In recent years the cell phone industry has changed the cell phones to use Enblock Dialing. With this dialing mode all the digits are dialed and then sent to the carrier after pressing the SEND key. Please check your telephone setup to confirm what dialing mode is used.

## SPEED DIALING

You can dial a preprogrammed telephone number stored in the system-wide speed dial list of numbers 500–999 or from your personal list of numbers 00–49.

Your system may be set for 950 system wide numbers. If so the system speed dial access codes are 050~999 and the station speed dial codes are 000~049.

- From the Main Fixed Feature screen with the handset on-hook, press the **SPEED DIAL** button or dial **16**.
- Dial the desired speed dial number.
- The telephone number is automatically dialed for you.

NOTE: If the Hot Keypad feature has been turned off, you must first lift the handset or press the **SPEAKER** button before you begin dialing.

### From the LCD:

- Press the **MENU** button.
- Scroll to the **PHONEBOOK** option, press **ENTER**.
- Scroll to **SEARCH**, press **ENTER**.
- Choose the method to be used to initiate a speed call, as described below.

**SEARCH**—Search and initiate speed dial calls by: Speed Dial Number, Associated Names, Telephone Numbers, Assigned Groups or Previous Calls, registered to the phone.

- Scroll to, or dial the associated number of the desired function. (Search, Outgoing Call, Incoming Call, Missed Call, New Number, Edit Group, Delete All, My Own Number) and press **ENTER**.
- Once in the menu, you may dial the selected number, change, delete or register the number. When the information is displayed, press **ENTER** to dial the number, press **MENU** to display further options.

1. **BY SPEED DIAL #:** Searches all speed dial numbers assigned to the phone. Enter the speed dial number of the party you wish to call. When the number is displayed, press **ENTER** and the number will be automatically dialed for you.

If you press **ENTER** without entering a speed dial number, all registered numbers will be displayed.

2. **BY NAME:** Searches for a telephone number by names associated with them. Enter the name in the “By Name” box and press **ENTER**. When the name is displayed, press **ENTER** again and all of the numbers associated with that name are displayed. Using the direction button, highlight the desired number. Press **ENTER** and the system will automatically dial it for you.

If you press **ENTER** without entering a name, all registered names will be displayed.

3. **BY PHONE NUMBER:** Searches for an entry by the phone number registered. Enter the phone number of the party you wish to call. Press **ENTER** and the number will be displayed from the PHONEBOOK. When the number is displayed, press **ENTER** and all information associated with that number is displayed.

If you press **ENTER** without entering a number, all registered numbers will be displayed.

Notes:

- Entering (\*123\*) searches all numbers that include the 123 in them.
- Entering 305\* searches all numbers that begin with 305.
- Entering \*3000 searches all numbers that end with 3000.

4. **BY GROUP:** Searches for an entries by group information registered. Scroll to group or enter associated number, press **ENTER**. The numbers registered to that group are displayed. Scroll to the desired number and press **SEND**. The number is automatically dialed for you.

5. **BY TIME:** Searches for entries based on incoming calls that have registered numbers on the set. Scroll to the desired entry and press **ENTER**. The information associated with that call will be displayed. Scroll to the desired number entry and press **SEND** to have the number dialed automatically for you.

## PROGRAMMING PERSONAL SPEED DIAL NUMBERS

You can program frequently dialed telephone numbers in a personal speed dial list. A station may be assigned up to fifty numbers, **00–49**. See your system administrator to determine the amount assigned to your station. The phone itself maintains 1000 station speed dial numbers.

- While on-hook, press **TRANSFER** and then dial **105**.
- Dial a speed dial number (**00–49**).
- Dial a line or line group access code.
- Dial the telephone number to be stored (24 digits maximum). It can include #, \*, FLASH and PAUSE.
- Press **TRANSFER** to store the number.

NOTE: If the Hot Keypad feature has been turned off, you must first lift the handset or press the **SPEAKER** key before you begin dialing.

### From the LCD:

- Press **MENU** button.
- Scroll to **PHONEBOOK** option, press **ENTER**.
- Scroll to **New Number** and press **ENTER**. Or you may dial [5] and immediately enter the option.
- Enter the name and all desired phone numbers for that particular speed dial entry and press **ENTER**.

## ONE TOUCH SPEED DIALING

You may assign any speed dial number to an already existing One Touch Speed Dial button for quick and easy dialing of frequently used numbers.

- While on-hook, press **TRANSFER** and then dial **107**.
- Press a One Touch Speed Dial button.
- Dial the speed dial number (**00–49** or **500–999**) that you want assigned to this button.
- Press **TRANSFER** to store your selection.

To call this telephone number, just press the One Touch Speed Dial button.

NOTE: If the Hot Keypad feature has been turned off, you must first lift the handset or press the **SPEAKER** key before you begin dialing.

## DIRECTORY DIALING

- Press the **SCREEN** button twice. Scroll to the first Fixed Feature screen.
- Press the **DIRECTORY** button.
- Press the soft button associated with the desired option.

**STN** - Accesses Station name directory,

**SYSTEM** - Accesses System speed dial name list.

**PERS** - Accesses your personal speed dial name list.

- Enter the first digit of the desired party.
- Press the **UP/DOWN** buttons to scroll to the desired entry.
- Press the appropriate operation soft button:

**DIAL** - Dials the displayed number.

**PREVIOUS** - Moves you to the previous entry.

**EXIT** - Exit programming and return to idle screen.

**NEXT** - Moves you to the next entry.

- Press **END** to return to idle screen.

## LAST NUMBER REDIAL

To redial the last telephone number you dialed, press the **REDIAL** button or dial **19**.

To redial the last telephone number you dialed, from the Main Fixed screen, press the **LAST REDIAL** button.

NOTES:

1. If the Hot Keypad feature has been turned off, you must first lift the handset or press the **SPEAKER** button before you begin dialing.
2. Redial does not apply to intercom calls.

## MANUAL RETRY WITH REDIAL

While you are on an outside call listening to a busy signal and you want to redial the same number dialed.

- Press the **REDIAL** button.

This will hang up your existing call and manually redial the same number dialed. You can repeat this operation for a limited number of attempts.

## SAVE NUMBER WITH REDIAL

To save the number you just dialed for later use, press the **SAVE/REPEAT** button before hanging up.

To redial this saved number at any time, press the **SAVE/REPEAT** button or dial **17**. The same line will be selected for you.

NOTES:

1. If the Hot Keypad feature has been turned off, you must first lift the handset or press the **SPEAKER** button before you begin dialing.
2. The saved telephone number is stored in memory until you save another number.
3. Redial does not apply to intercom calls.

## AUTOMATIC REDIAL/RETRY

When you are making an outside call and you receive a busy signal, the system can automatically redial the number for you. It will automatically redial at a pre-programmed interval for up to 15 attempts.

- When you hear a busy signal, press the **AUTO-RETRY** button.
- The system will reserve the line and automatically redial the same number for you. You will hear the call being made through the keyset speaker. The microphone is muted.
- When the called party answers, lift the handset or press the flashing **SPEAKER** to begin speaking.

NOTES:

1. If you make another call, auto-redial is canceled.
2. To cancel an auto-retry, lift and replace the handset.

## PULSE TO TONE CHANGEOVER

When making an outside call on a dial pulse line, press #. All digits dialed after the # will be sent as tones.

## MEMO REDIALING

When you are calling directory information, you can store the number you are given using the **SAVE** feature. There is no need for pencil and paper.

- While you are talking on an outside call, press **SAVE**.
- Dial the telephone number as it is dictated to you on the key pad.
- Press **SAVE** to store the number.

To dial the number, press the **SAVE/REPEAT** button. It will select the same line and dial the stored number. If necessary, you can select a different line and then press the **SAVE/REPEAT** button.



# PAGING AND MESSAGING

## MAKING AN INTERNAL PAGE

To make an announcement through the keyset speakers in the idle condition:

- Lift the handset.
- Press the **PAGE** button or dial **55**.
- Dial the desired zone number **0, 1, 2, 3** or **4**.
- After the attention tone, make your announcement.

### NOTES:

1. If you have a dedicated page zone button, it is not necessary to press **PAGE** and dial a zone number.
2. If allowed by your system administrator you may be able to initiate a page from a speakerphone by pressing the **PAGE** key or dialing **55** without lifting the handset.

## MAKING AN EXTERNAL PAGE

To make an announcement through the external paging speakers:

- Lift the handset.
- Press the **PAGE** button or dial **55**.
- Dial the desired zone number **5, 6, 7** or **8—OR—dial 9** to page all external zones.
- After the attention tone, make your announcement.

### NOTES:

1. If you have a dedicated page zone button, it is not necessary to press **PAGE** and dial a zone number.
2. If allowed by your system administrator you may be able to initiate a page from a speakerphone by pressing the **PAGE** key or dialing **55** without lifting the handset.

## ALL PAGE

To page all designated keysets in internal zone 0 and all external zones at the same time:

- Lift the handset.
- Press the **PAGE** button or dial **55**.
- Dial **\*** or press the **ALL PAGE** button.
- After the attention tone, make your announcement.

### NOTES:

1. The LED on the **PAGE** button will only light when an All Page is in progress.
2. If allowed by your system administrator you may be able to initiate a page from a speakerphone by pressing the **PAGE** key or dialing **55** without lifting the handset.

## MEET ME PAGE

- Lift the handset.
- Press the Meet Me Page (**MMPG**) button or dial **54**.
- Dial the desired zone number.
- After the attention tone, instruct the paged person to dial **56**.
- Press **WAIT** or **TRANSFER**.
- Remain off-hook until the person dials **56** from any phone.
- The paged person will be automatically connected with you.

## CALL PARK AND PAGE

When you have an outside call for someone who is not at his/her desk, you can park the call prior to paging. The OfficeServ 100, OfficeServ 500, and OfficeServ 7000 Series systems offer two different methods:

### MANUAL PARK ORBITS

- While in conversation, press the **PARK** button.
- Entered a desired orbit number (**0-9**), if the orbit number is busy dial another orbit number. Display users can press **\*** to automatically place the call in any available orbit number and see the number in the display.
- Remember the selected orbit number.
- Replace the handset when finished.
- Lift the handset and make a page announcement as previously described (example: "John Smith park two").

### To retrieve a parked call from orbit:

- Press the **PARK** button and dial the announced orbit number (**0-9**).
- You will be connected to the parked call.

### NOTES:

1. You must have a **PARK** button or park access code to retrieve and place calls in park orbits.
2. If the parked call is not retrieved within a pre-programmed period of time, it will recall your keyset and have a slow flashing amber light. You cannot park and page intercom calls.
3. If the Hot Keypad feature has been turned off, you must first lift the handset or press the **SPEAKER** button before you begin dialing.

## AUTOMATIC PARK WITH PAGE BUTTON

- While in conversation, press the **PAGE** button. The call is automatically parked at your station.
- Receive page tone and dial a desired page zone number.
- Make announcement indicating your extension number or the line number. Hang up.

### To retrieve an automatically parked call:

- Dial **10** plus the number that was announced. If you have a **PAGPK** button, press it and dial the number that was announced. If you have a **PARK** button, press it and dial the announced orbit number.
- You will be connected to the parked call.

### NOTES:

1. If the call is not retrieved within a pre-programmed period of time, it will recall your keyset and have a slow flashing amber light. You cannot park and page intercom calls.
2. If the Hot Keypad feature has been turned off, you must first lift the handset or press the **SPEAKER** button before you begin dialing.

## SETTING A MESSAGE INDICATION

When you are calling another station and no one answers or you receive a busy signal, you can leave a message indication:

- Press the **MESSAGE** button—**OR**—dial **43** and receive confirmation tone. Hang up.
- The message button on the Main Programmable Button screen and the TSI will flash at the called station.

### NOTES:

1. A station can have up to five message indications.
2. If the Hot Keypad feature has been turned off, you must first lift the handset or press the **SPEAKER** button before you begin dialing.

## CANCELING MESSAGES

To cancel a message indication that you left at another station, dial **42** plus the extension number of the station at which you left a message.

To cancel all message indications left at your keyset, dial **42** plus your extension. Your **MESSAGE** button indicator will stop flashing and the TSI will go out.

NOTE: If the Hot Keypad feature has been turned off, you must first lift the handset or press the **SPEAKER** button before you begin dialing.

## RETURNING MESSAGES

- Press the **MESSAGE** button or dial **43**. The first station that left a message will be called automatically. If that station does not answer, your **MESSAGE** button indicator will continue to flash and the TSI will stay on.
- Repeat until all messages have been returned in the order received.
- Your **MESSAGE** button indicator will stop flashing and the TSI will turn off when all messages have been returned.

### NOTES:

1. Display keyset users can view message indications and return them in any order. [See \*Viewing Message Indications under Display Features\*](#).
2. If the Hot Keypad feature has been turned off, you must first lift the handset or press the **SPEAKER** button before you begin dialing.
3. If a message has been left at your keyset by a keyset in Auto Answer, you must manually cancel the message after it has been returned.

## PROGRAMMED MESSAGES

When you will be away from your phone for any length of time, you can leave a programmed station message. Display stations calling you will see this message and be informed of your status or follow your instructions.

- Dial **48** plus any of the message codes (**01–20**) listed on the back of this user guide.
- To cancel any of these messages you might have selected, dial **48** plus **00**.
- Press **TRANSFER** to exit and store your selection.

NOTE: If the Hot Keypad feature has been turned off, you must first lift the handset or press the **SPEAKER** button.

You can have multiple programmed message buttons (**PMSG**) and each one can have a different message code:

- Press any programmed message (**PMSG**) button. The message is set and the PGM MSG button indicator will be lit steady. Press the button again to turn off the programmed message and the indicator will go blank.
- Pressing another programmed message (**PMSG**) button will turn the previous one off and set a different programmed message.

# CONVENIENCE FEATURES

## LOGGING IN AND OUT

If enabled, your ITP-5112L telephone may require you to log in before making or receiving calls. In these cases your telephone system administrator will provide you with an extension number, password, and the feature code used to log out.

### To log in:

- Press **ENTER** to begin login.
- Dial your extension number.
- Press **ENTER**.
- Dial your password.
- Press **ENTER** twice.

### To log out:

- Dial the feature code provided by your administrator (for example 77).

## DO NOT DISTURB

Use this feature when you want to block calls to your keyset.

- While on-hook, press the **DND** button or dial **401**. The **DND** button indicator will be lit steady to remind you of this mode.
- To cancel **DND**, press the **DND** button again or dial **400**. The **DND** button indicator goes blank. You can make calls while in the DND mode.

### NOTES:

1. If the Hot Keypad feature has been turned off, you must first lift the handset or press the **SPEAKER** button.
2. If you place your keyset in **DND** mode and you do not have a **DND** button, your **TSI** button will flash to indicate DND status.

## ONE TIME DND

If you are on a call and you do not wish to be interrupted while on that call, you can press the **DND** button and place your station in Do Not Disturb. When you hang up at the end of the call, DND will be automatically canceled and your keyset will be able to receive new calls. This feature requires a **DND** button.

## MUTE

You can mute the handset transmitter or the microphone during any conversation:

- Press the **MUTE** button. The **MUTE** button indicator will be lit steady.
- To resume speaking, press the **MUTE** button again. The **MUTE** button indicator goes blank.

## BACKGROUND MUSIC

When a music source is supplied, you may listen to music through the speaker in your keyset:

- While on-hook, press the **HOLD** button to hear music.
- Press the **HOLD** button again to turn music off.

You can set the level of background music by using the **VOLUME** buttons while listening to the music. This does not affect the speakerphone level.

## ESTABLISHED CALL PICKUP

To pick up an established call in progress at a single line extension connected to a computer modem on your PC.

- Press the **EP** button for that station on your keyset and the call is automatically moved to your keyset.
- The single line extension on your modem will be disconnected.

NOTE: You must have an assigned (**EP** button) button on your regular keyset, for the single line station.

## APPOINTMENT REMINDER / ALARM REMINDER

### ALARM CLOCK

This feature works like an alarm clock. Use it to remind yourself of an appointment later in the day (TODAY ONLY) or as a daily reminder every day (DAILY). You can set up to three alarms. Each one can be either a TODAY ONLY or a DAILY alarm.

When the alarm rings, you will hear three short rings repeated three times. Lift the handset to answer the alarm. If you do not, the alarm will alert you two more times at five minute intervals.

Set alarm for desired duration (Everyday, Once). These alarms can be used to remind you of an appointment later in the day (Once) or as a daily reminder

(Everyday). There are two possible alarms. Each can be either a today (Once) or a daily (Everyday) alarm.

#### To set alarms:

- Press **TRANSFER** and then dial **112**.
- Dial the alarm number **1, 2** or **3**.
- Dial the time at which you want the alarm to sound. Enter the time as HHMM (hours and minutes) using the 24 hour clock.
- Dial **0** (NOT SET), **1** (TODAY ONLY) or **2** (DAILY) to select the alarm type.
- Press **TRANSFER** to save.
- Repeat for each alarm if needed.

#### To cancel individual alarms:

- Press **TRANSFER** and then dial **112**.
- Dial alarm number **1, 2** or **3**.
- Press the **HOLD** key.

#### From the LCD:

- Press **MENU** button.
- Scroll to **E-DIARY** option, press **ENTER**.
- Scroll to **ALARM** option and press **ENTER—OR—**you may dial 2 and immediately enter the option.
- Choose the desired **ALARM NUMBER (1/2)**.
- Enter **TIME** via the dial pad in 24-hour format.
- Set **RING TONE** via the direction button (left/right). Each tone is heard.
- Set **REPEAT DURATION** via the direction button.
- Press **ENTER** when finished.

#### To clear alarm:

- Scroll to **CLEAR** option in Alarm Clock setting screen and press **ENTER**.

#### DAILY PLANNER

Scheduling feature with message. Allows the scheduling of up to 30 alarm reminders. Each of these reminders can have an associated message of up to 32 characters. These reminders can be scheduled to ring one hour before, one half hour before or right at the exact time set.

- Press **TRANSFER** and then dial **116**.
- Dial the alarm number **1, 2** or **3**.
- Dial the time you want the alarm to go off. Enter the time as HHMM (hours and minutes) using the 24 hour clock.
- Dial **0** (NOT SET), **1** (TODAY) or **2** (DAILY) to select the alarm type.

- Write your message using the dial pad keys. Each press of a key selects a character. Pressing the next key moves the cursor to the next position. For example, if your message is "TAKE MEDICATION," press **8** once to get the letter "T." Press **2** once to get "A." Press **5** twice to get "K." Continue selecting characters from the following table to complete your message.
- Press the **TRANSFER** key to store the alarm and reminder message.
- Repeat for each alarm if needed.

#### From the LCD:

- Press **MENU** button.
- Select **E-DIARY**.
- Select **DAILY PLANNER**.
- Press direction button **UP/DOWN** to set the month. Press direction button **LEFT/RIGHT** to set the date. Press **ENTER** on the desired date.
- Press **MENU** then **ADD**.
- Enter the **TIME** desired for the alarm (in 24 hour format).
- Enter the message in the **CONTENTS** field.
- Write your message using the dial pad buttons. Each press of a key selects a character. Pressing the next key moves the cursor to the next position. For example, if your message is "TAKE MEDICATION," press 8 once to get the letter "T." Press 2 once to get "A." Press 5 twice to get "K." Continue selecting characters from the following table to complete the message.
- Enter **ALARM ALERT** period.
- Set **RING TONE**.
- When all information is set, press **ENTER**.

COUNT	1	2	3	4	5
DIAL 0	<	>	.	)	0
DIAL 1	space	?	,	!	1
DIAL 2	A	B	C	@	2
DIAL 3	D	E	F	#	3
DIAL 4	G	H	I	\$	4
DIAL 5	J	K	L	%	5
DIAL 6	M	N	O	^	6
DIAL 7	P	Q	R	S	7
DIAL 8	T	U	V	Q	8

DIAL 9                    W                    X                    Y                    Z                    9

DIAL \*                    :                    =                    [                    ]                    \*

#### NOTES:

1. When the character you want appears on the same dial pad key as the previous character, press **UP** to move the cursor one space to the right.
2. Other symbols are available for DIAL #.

## ANSWERING THE DOOR PHONE

When you are programmed to receive calls from a door phone:

- You will receive three short rings repeated.
- Lift the handset. You are connected to the door phone.
- If an electric door lock release is installed, dial **13** to unlock the door.

## CALLING THE DOOR PHONE/ ROOM MONITOR

You may call the door phone and listen to what may be happening outside or in another room.

- Dial the extension number of the door phone.
- You will be connected to the door phone and you can listen or have a conversation.
- If an electric door lock release is installed, dial **13** to unlock the door.

NOTE: If the Hot Keypad feature has been turned off, you must first lift the handset or press the **SPEAKER** button.

## EXECUTIVE/SECRETARY HOT LINE

If programmed, an executive and a secretary can have a hot line between them. When the executive station is in the DND mode, all of its calls will ring the secretary station. If the secretary does not answer, the caller will go to the secretary's voice mail box if setup.

When an Executive/Secretary hotline is programmed to this keyset, the keyset offers an additional screen option. This screen has options for setting the status of the keyset user. This status update is viewable to EasySet users only.

- Either person can press the **BOSS** button to make a voice call to the other station.
- Using the hot line will override DND at the other station. This button will have a flashing indication when the other station is in use.

#### To transfer a call to a Boss in DND:

- Press the **TRANSFER** button followed by the **BOSS** button.
- Wait for the **BOSS** to answer, then announce the call and hang up to complete the transfer—**OR**—hang up to complete a blind transfer after pressing the **BOSS** button.

#### To send a text message to the Boss display:

- Press the **TRANSFER** button followed by the **EXE/SECR MSG** soft button.
- Scroll to the desired message and press **ENTER** (the BOSS station gets three short ring bursts, followed by the message).
- This method gives you the option to transfer the call to another station if so desired.
- Press the **TRANSFER** button again to be reconnected to the caller.
- Take the necessary action (the BOSS cancels DND and transfer the call or take a message)—**OR**—press the **EXE/SECR MSG** soft button, scroll to the desired message and press **ENTER** (while maintaining contact with the caller). This method does not give you the option to transfer the call to another station.
- Take necessary action (take message, etc.)

#### To set up the Executive/Secretary messages (10 each):

- Press **BOSS/SECR** button and establish a connection.
- Press the **EXE/SECR MSG** button. The first message screen is displayed. Pressing the **DOWN** arrow in the upper left corner of the LCD will scroll you to the second screen. Pressing the **UP** arrow in the upper right corner of the LCD will return you to the first screen.
- This method gives you the option to transfer the call to another station if so desired.
- Scroll to the desired message.
- Press **MENU** button for options (Send, Edit, and Remove)
  - SEND** - Sends the message to the other end.
  - EDIT** - Enter message from the dial pad.
  - REMOVE** - Deletes message. Use remove option to delete the "Blank Message" default message.

#### From the BOSS station in DND:

- Receive three short, double ring bursts, followed by the text message from the Secretary.
- Press **ENTER** to invoke **REPLY** option—**OR**—scroll to **OK** option and press **ENTER**.
- If **REPLY** option is activated, the Select Message screen is displayed.
- Scroll to the desired message and press **ENTER**. The message is sent to the Secretary keyset display and the Secretary station has the option to reply, if so desired.

### **Sending a text message from the BOSS keyset to the Secretary keyset, from the idle condition:**

- Press the **EXE/SECR MSG** button.
- Press the **NEXT** button (if there are more than two Secretary stations assigned to that BOSS station, all Secretary keysets will be displayed), in the case of multiple Secretary stations, scroll to the desired Secretary, press the soft key associated with that Secretary and press **NEXT** button.
- Scroll to the desired message and press the associated soft key or **ENTER**.
- The message is sent.

### **Executive Divert:**

- From the BOSS keyset when the keyset rings, press the **EXEC DIVERT** button. The call is forwarded to the Secretary station.
- Pressing the **EXEC DIVERT** button, when the keyset is in idle status, will divert all calls after, to the Secretary station. Pressing the **EXEC DIVERT** button again, will cancel the divert function.

## **GROUP LISTENING**

When you are engaged on a call and you are using the handset, you may want other people to hear the distant party's voice over the speaker:

- Press the **LISTEN** button to turn on the speaker. The microphone is not in use, so the distant party does not hear other parties present in your office.
- Press **LISTEN** again to turn the speaker off and resume private conversation.
- Repeat if necessary.

NOTE: Depending on speaker volume and the acoustics of your office, it may be advisable to turn the group listening feature off before hanging up. This will eliminate a momentary squeal.

## **ACCOUNT CODES**

When enabled, your system allows calls to be charged to different accounts. You can enter account codes either by dialing the full code, by entering an account code "bin number", or by pressing your **ACC** key if one is assigned. Bin numbers are a 3 digit short code that will automatically insert the appropriate account code. Account codes may be a maximum of 12 digits (# may be used); if the account code is to be less than 12 characters you may end the code by pressing **\*** or the right soft key. The type of code used is determined by your telephone system administrator. Codes can be entered before or during a call as follows:

To enter an account code before placing the call:

- Press your **ACC** key or dial **47**.
- Dial the account code or bin number.

- You will receive a confirmation tone and display.
- When prompted dial a trunk or trunk group (i.e. 9) and the telephone number to call.

To enter an account code by interrupting the conversation:

- While on an outside call press the **ACC** key or press **TRANSFER** followed by **47**.
- Dial the account number or bin number (if you are entering an account code you will need to press your **ACC** key or right soft key to finalize the entry)

NOTE: If you make an error simply repeat the procedure with the correct code. Only the most recent account code dialed will be recorded.

## **LOCKING YOUR KEYSSET**

You can lock your keyset to control misuse of your phone while you are away. You can unlock it when you return.

- Press **MENU** button.
- Scroll to **MY PHONE** option. Press **ENTER**.
- Scroll to **LOCKED** option and press **ENTER—OR—**you may press 4 and immediately access option.
- Enter the **PASSWORD**. Press **ENTER**. (Default Password is "1234").
- Use Direction button to scroll **LEFT/RIGHT** to choose desired mode.
  - 1. UNLOCKED** - No restrictions. User may complete internal and outside calls.
  - 2. LOCKED OUTGOING** - Restricted to incoming calls only. No outside calls can be made. When 911 is programmed, 911 emergency dialing is allowed.
  - 3. LOCKED ALL** - No calls, incoming or outgoing allowed to or from the set.
- Press **ENTER**.
- Press **CANCEL** to return to Main Config Menu—**OR—**press **END** to return to idle screen.

## **MANUAL SIGNALLING**

Use this feature when you want to send a brief 500ms ring burst to another station, regardless of the status of your phone (on-hook, off-hook, handsfree, DND, or ringing).

**To send a signal to another station:**

- Press the Manual Signalling (**MS**) button.
- You may press the **MS** button repeatedly to send multiple signals to the designated station.

**NOTE: Your phone must have a Manual Signalling (MS) button with a station number extender assigned to it.**

## OFF-HOOK VOICE ANNOUNCE

Keysets may receive a voice announcement while on another call. The calling station must have an **OHVA** button. When you are in DND, you cannot receive OHVA calls. The OHVA feature will work with intercom and transferred calls.

When you receive an OHVA and secure OHVA is ON, you will hear the announcement in the handset receiver, if you are using the handset. If secure OHVA is OFF then you will hear the announcement on the speaker, if you are talking on the handset. If you are using the speakerphone the announcement will always be heard through the speaker.

### To make an off-hook voice announcement:

- Dial the extension number or press the **DSS** button.
- When you receive a busy signal, press the **OHVA** button.
- After the attention tone, begin speaking.
- Finish the call by replacing the handset.
- Press the flashing **CALL** button on your keyset. This will place the original party on hold and allow you to talk to the announcing party.
- To return to your first party, press the button corresponding to your original call. This will disconnect the OHVA call.

### NOTES:

1. When you are voice announcing to a station close to you, use the handset to avoid an echo effect.
2. You cannot off-hook voice announce to single line telephones.

## OHVA BLOCK

Your keyset can be programmed with an OHVA Block (**BLOCK**) button. Pressing this button will prevent anyone from making an OHVA to you until you press the button again and cancel the blocking.

## OHVA REJECT

Your keyset can be programmed with an OHVA Reject (**REJECT**) button. Pressing this button while receiving an OHVA call will disconnect the voice announcing party and return you to your original call.

## IN GROUP/OUT OF GROUP

If your keyset is assigned to a station ring group, you can remove your keyset from the group and then put it back in. While you are out of the group, you can receive calls to your extension number but not calls to the group number. If you have an **IN/OUT** button with the group number assigned.

- Press the **IN/OUT** button. The button indicator will be lit steady when your keyset is in the group.
- Press the **IN/OUT** button again to exit the group and the indicator will go blank. Repeat as necessary.

If you do not have an **IN/OUT** button:

- Dial the **IN/OUT** access code number \_\_\_\_\_, then the group number, then **0** to exit the group or **1** to enter the group.

NOTE: If the Hot Keypad feature has been turned off, you must first lift the handset or press **SPEAKER** button.

The **IN/OUT** button can include an extender to indicate the specific group that this button will affect. This means that if you are in multiple groups, you can decide for which groups you will receive calls.

# CUSTOMIZING YOUR KEYSSET

## AME PASSWORD

This feature allows customers using the AME feature to enable password protection. This will prevent unauthorized users from listening to your messages being left. The passcode is the same as your station passcode. This feature only applies if there is a Samsung Voicemail card installed in the system and your keyset has a programmed AME button.

- With the handset on-hook, press **TRANSFER** and then dial **110**.
- Dial **101** to turn on AME PASSCODE or **100** to turn it off.
- Press **TRANSFER** to store your selection.

### From the LCD:

- Press **MENU** button.
- Scroll to **SETUP** option and press **ENTER**.
- Scroll to **STATION ON/OFF** and press **ENTER—OR—**you may dial **6** and immediately enter the option.
- Scroll to **AME** password and press **ENTER** to change status.
- Press **CANCEL** to return to the Main Option Page—**OR—**press **END** to return to the idle screen.

## AUTO CAMP-ON

This option allows intercom calls to be automatically camped on, if possible, when a busy station is called.

- With the handset on-hook, press **TRANSFER** and then dial **110**.
- Press **081** to turn CAMP-ON on or **080** to turn it off.
- Press **TRANSFER** to store your selection.

### From the LCD:

- Press **MENU** button.
- Scroll to **SETUP** option and press **ENTER**.
- Scroll to **STATION ON/OFF** and press **ENTER—OR—**you may dial **6** and immediately enter the option.
- Scroll to **AUTO CAMP-ON** and press **ENTER** to change status.
- Press **CANCEL** to return to the Main Option Page—**OR—**press **END** to return to the idle screen.

## SELECT RING TONE

Each ITP-5112L user can select from a variety of ring tones.

### From the LCD:

- Press **MENU** button.
- Scroll to **SOUND/SCREEN** option and press **ENTER**.
- Scroll to **RING TONE SELECT** and press **ENTER—OR—**you may dial **1** and immediately enter the option.
- Select from one of the three categories:
  1. Standard Ring Tones
  2. Melody or
  3. My Ring Tones
- Press **ENTER** to select. Use **LEFT/RIGHT** arrow buttons to scroll through the available ring tones and press **ENTER** to **SAVE**.
- Press **CANCEL** to return to the Main Option Page—**OR—**press **END** to return to idle screen.

## CHANGE YOUR PASSCODE

From the factory, your station passcode is 1234. You can change your station passcode whenever you desire.

- While on-hook, press **TRANSFER** and then dial **101**.
- Dial your old passcode.
- Dial a new passcode (must be four characters). You can use **0–9**.
- Redial the new passcode to verify. If successful, you will hear two beeps. Four beeps indicate an incorrect code. Reenter the code again.
- Press **TRANSFER** to store the new passcode.

### From the LCD:

- Press **MENU** button.
- Scroll to **MY PHONE** option and press **ENTER**.
- Scroll to **CHANGE PASSWORD** and press **ENTER—OR—**you may dial **3** and immediately enter the option.
- Enter **CURRENT PASSWORD**, press **ENTER**.
- Enter **NEW PASSWORD** and press **ENTER**.
- Enter **NEW PASSWORD** again, for confirmation and press **ENTER**.
- Press **CANCEL** to return to the Main Option Page—**OR—**press **END** to return to idle screen.



## SET ANSWER MODE (INTERCOM)

You can receive internal calls in one of three modes ([see Answering Intercom Calls under Intercom Calls](#) for descriptions).

- While on-hook, press **TRANSFER** and then dial **103**.
- Dial **0** for Ringing, **1** for Auto Answer or **2** for Voice Announce.
- Press **TRANSFER** to store your selection.

### From the LCD:

- Press **MENU** button.
- Scroll to **SETUP** option and press **ENTER**.
- Scroll to **ANSWERING MODE** and press **ENTER—OR—**you may dial **1** and immediately enter the option.
- Select desired station ring type setting. (Ring, Auto Answer, or Voice Announce).
- Press **ENTER** to select and **SAVE**.
- Press **CANCEL** to return to the Main Option Page—**OR—**press **END** to return to idle screen.

NOTE: When your keyset is programmed for Auto Answer and you have Forward No Answer (FNA) turned on, you must answer screened transfers by pressing the **SEND** button before your FNA timer expires or the call will forward.

## SET ANSWER MODE (CO)

Your incoming CO calls can be set to follow the intercom answer mode.

- While on-hook, press **TRANSFER** and then dial **110**.
- Dial **15** to access **AUTO ANS CO**.
- Press the **VOLUME UP** or **DOWN** key to change status.
- Press **TRANSFER** to store your selection.

## AUTOMATIC HOLD

While on an outside call, pressing a line button, route button or a flashing **CALL** button will automatically put your call on hold and connect you to the next call. This feature can be turned on or off at your keyset.

- With the handset on-hook, press **TRANSFER** and then dial **110**.
- Dial **001** to turn Automatic Hold on or **000** to turn it off.
- Press **TRANSFER** to store your selection.

### From the LCD:

- Press **MENU** button
- Scroll to **SETUP** option and press **ENTER**.
- Scroll to **STATION ON/OFF** and press **ENTER—OR—**you may dial **6** and immediately enter the option.
- Scroll to **AUTO HOLD**, press **ENTER** to change option status.
- Press **CANCEL** to enter change and return to the Main Configuration Menu—**OR—**press **END** to return to idle screen.

NOTE: Intercom calls can be automatically put on hold by pressing **TRANSFER**.

## HEADSET OPERATION

Keyset users can switch between headset mode and handset mode. When using headset mode, press the **SEND** and **END** buttons to answer and release calls.

- With the handset on-hook, press **TRANSFER** and then dial **110**.
- Dial **021** to use the headset or **020** to use the handset.
- Press **TRANSFER** to store your selection.

### From the LCD:

- Press **MENU** button.
- Scroll to **SETUP** option and press **ENTER**.
- Scroll to **STATION ON/OFF** and press **ENTER—OR—**you may dial **6** and immediately enter the option.
- Scroll to **HEADSET USE** and press **ENTER** to change option status.
- Press **CANCEL** to enter change and return to Main Configuration Menu—**OR—**press **END** to return to idle screen.

Your keyset may be equipped with a Headset mode button. If it is so equipped pressing this button while the button indicator is blank will cause the keyset to enter headset mode and the button indicator to be lit solid to indicate this. Pressing the button while the button indicator is lit solid will cause the keyset to return to handset mode and the button indicator will go blank.

## HOT KEYPAD

On your phone system your keyset's keypad can be made "live" or "hot" so that it is not necessary to lift the handset or press the **SPEAKER** button before you begin dialing. Calls can be made and features activated by simply dialing the C.O. line number, trunk group access code, intercom number or feature access code.

- With the handset on-hook, press **TRANSFER** and then dial **110**.
- Dial **031** to turn the Hot Keypad on or **030** to turn it off.
- Press **TRANSFER** to store your selection.

#### From the LCD:

- Press **MENU** button.
- Scroll to **SETUP** option, press **ENTER**.
- Scroll to **STATION ON/OFF** and press **ENTER**—**OR**—you may dial **6** and immediately enter the option.
- Scroll to **HOT KEYPAD**, press **ENTER** to change option status.
- Press **CANCEL** to enter change and return to Main Configuration Menu—**OR**—press **END** to return to idle screen.

## KEY CONFIRMATION TONE

You can hear a short beep (confirmation tone) each time you press a button on the dial pad. This tone can be turned on or off.

- While on-hook, press **TRANSFER** and then dial **110**.
- Dial **040** to turn tones off or **041** to turn tones on.
- Press **TRANSFER** to store your selection.
- Additional ring tones can be selected from the **SOUND/SCREEN**, “Keytone Select” option.

## REJOINING A PAGE

This feature allows you to hear the remaining portion of an ongoing internal page after you return your keyset to idle. To enable this feature:

- With the handset on-hook, press **TRANSFER** and then dial **110**.
- Dial **051** to turn this feature on or **050** to turn it off.
- Press **TRANSFER** to store your selection.

#### From the LCD:

- Press **MENU** button.
- Scroll to **SETUP** and press **ENTER**.
- Scroll to **STATION ON/OFF** and press **ENTER**—**OR**—you may dial **6** and immediately enter the option.
- Scroll to **PAGE REJOIN**, press **ENTER** to change option status.
- Press **CANCEL** to enter change and return to the Main Configuration Menu—**OR**—press **END** to return to idle screen.

## RING PREFERENCE

This feature automatically answers ringing calls when you lift the handset or press the **SEND** button. This method will always answer calls in the order they arrived at your keyset. When you turn ring preference off, you must press the flashing button to answer a call, allowing you to answer calls in the order you choose.

- With the handset on-hook, press **TRANSFER** and then dial **110**.
- Dial **061** to turn ring preference on or **060** to turn it off.
- Press **TRANSFER** to store your selection.

#### From the LCD:

- Press **MENU** button.
- Scroll to **SETUP** option, press **ENTER**.
- Scroll to **STATION ON/OFF** and press **ENTER**—**OR**—you may dial **6** and immediately enter the option.
- Scroll to **RING PREF**, press **ENTER** to change option status.
- Press **CANCEL** to enter change and return to Main Configuration Menu—**OR**—press **END** to return to idle screen.

## AUTO ANSWER CO CALLS

This option will allow CO calls that directly ring your phone to auto answer. When a CO call arrives at your station and this option set for ON your phone will sound two beeps, the same as when a screened transfer is completed, and you will be connected to the CO call. In order for this option to work the station must also be programmed for auto answer ([see Set Answer Mode](#)).

- Press **MENU** button.
- Scroll to **SETUP** option, press **ENTER**.
- Scroll to **STATION ON/OFF** and press **ENTER**—**OR**—you may dial **6** and immediately enter the option.
- Scroll to **AUTO ANS CO CALL**, press **ENTER** to change option status.
- Press **CANCEL** to enter change and return to Main Configuration Menu—**OR**—press **END** to return to idle screen.

NOTE: Outside lines must ring your station directly for the Auto Answer CO to work. Lines ringing a station group will not cause your phone to Auto Answer the call.

## DISPLAY SPEED DIAL NAME

This option allows you to view the name associated with a speed dial number as it is dialed.

- With you handset on-hook, press **TRANSFER** and then dial **110**.
- Press **111** to turn **DISP SPDNAME** on or **110** to turn it off.
- Press **TRANSFER** to store your selection.

#### From the LCD:

- Press **MENU** button.
- Scroll to **SETUP** option, press **ENTER**.

- Scroll to **STATION ON/OFF** and press **ENTER**—**OR**—you may dial **6** and immediately enter the option.
- Scroll to **DISP SPDNAME**, press **ENTER** to change option status.
- Press **CANCEL** to enter change and return to Main Configuration Menu—**OR**—press **END** to return to idle screen.

## CALLER ID REVIEW ALL

This feature allows display keyset users to review Caller ID information for calls sent to their stations. This list can be from ten to fifty calls in a first in, first out basis. The list includes calls that you answered and calls that rang your station but that you did not answer. When reviewing this list, you can press one button to dial the person back. The system must be using LCR to dial the stored number.

- With you handset on-hook, press **TRANSFER** and then dial **110**.
- Press **121** to turn **CID REVIEW ALL** on or **120** to turn it off.
- Press **TRANSFER** to store your selection.

### From the LCD:

- Press **MENU** button.
- Scroll to **SETUP** option, press **ENTER**.
- Scroll to **STATION ON/OFF** and press **ENTER**—**OR**—you may dial **6** and immediately enter the option.
- Scroll to **CID REVIEW ALL**, press **ENTER** to change option status.
- Press **CANCEL** to enter change and return to Main Configuration Menu—**OR**—press **END** to return to idle screen.

## SECURE OHVA

This option allows you to receive OHVA (Over Head Voice Announce) calls via the speaker while you are on the handset.

- With your handset on hook, press **TRANSFER** and then dial **110**.
- Press **131** to turn **SECURE OHVA ON** or **130** to turn it **OFF**.
- Press **TRANSFER** to save your selection.

### From the LCD:

- Press the **MENU** button from the idle screen.
- Select **SETUP**.
- Select **STATION ON/OFF**.
- Scroll to **SECURE OHVA** and press **ENTER** to change status.
- Press **CANCEL** to return to option Main Screen.
- Press the **END** to return to idle screen.

## CONFIGURE MOBILE EXTENSIONS (MOBEX)

This feature allows you to configure options for any Mobile Extension (MOBEX) ports that are assigned to you by your telephone system administrator. You can turn a port on or off; set the telephone number for the port; or set the caller ID you will be calling in from. The caller ID field has no effect unless you have been authorized as an Executive MOBEX user. Check with your telephone system administrator for further details on your specific system configuration.

### To set the phone number a MOBEX port can reach you on:

- Press **TRANSFER** and then dial **126**.
- Dial your station pass code.
- Dial the number of the port you wish to configure (1-5) (you may also use the Volume Up and Volume Down keys to select a port and press the right soft key to confirm).
- Dial **0** to select the telephone option.
- Dial the number of a C.O. line to use when making calls to this MOBEX port.
- Dial the phone number you can be reached at by users calling this MOBEX port.
- Press **TRANSFER** to store your selection and exit programming.

### To set the caller ID of the location you will be calling in from:

- Press **TRANSFER** and then dial **126**.
- Dial your station pass code.
- Dial the number of the port you wish to configure (1-5) (you may also use the Volume Up and Volume Down keys to select a port and press the right soft key to confirm).
- Dial **1** to select the caller ID option.
- Dial the phone number you will be calling in from.
- Press **TRANSFER** to store your selection and exit programming.

### To turn a MOBEX port ON or OFF:

- Press **TRANSFER** and then dial **126**.
- Dial your station pass code.
- Dial the number of the port you wish to configure (1-5) (you may also use the Volume Up and Volume Down keys to select a port and press the right soft key to confirm).
- Dial **2** to select the activation status option.
- Dial **0** to turn the port on, dial **1** to turn the port off.
- Press **TRANSFER** to store your selection and exit programming.

# DISPLAY FEATURES

## DIRECTORY INFORMATION

An 11 character directory name can be assigned to each extension number. Display keyset users can view the name of the called or calling station before answering.

Each outside line can have an 11 character directory name. Incoming calls can be easily identified and answered with different greetings.

Outside and internal calls ringing to a station group will display [CALL FOR xxx] where xxx is the station group number. This allows you to answer calls directed to you differently than calls directed to your group.

## CALL LOG

The system can log both incoming and outgoing calls placed from or to your telephone. You must have a **LOG** button programmed on your keyset and assigned a review list.

Each **IN** and **OUT** list can be up to 50 numbers maximum. They are assigned in blocks of 10 each.

- Press the **LOG** key.
- Press either the **IN** or **OUT** key.
- View the first IN/OUT telephone number. At this point you may select one of the three options related to this number or use the UP/DOWN keys to scroll through your list of calls.
- Press the **CLEAR** button to erase this number from the list.
- Press the NND key repeatedly to view the Name, Number, or Date associated with this call.
- Press the **DIAL** key to call this number.

These options are the same for the incoming or outgoing call logs.

You can also review your Call Log by following the steps below:

- From the idle screen, you can press the **MENU** button.
- Select **PHONEBOOK**.
- Select Outgoing, Incoming or Missed Call Logs.

## DIAL BY NAME

Each station or speed dial number can have an associated directory name. A station or speed dial number can be selected by scrolling alphabetically through a directory name list. This on-line “phone book” allows the user to look up and dial any station or speed dial number in seconds.

- Press **MENU** button
- Scroll to **PHONEBOOK** option, press **ENTER**.
- Scroll to **SEARCH** and press **ENTER**—**OR**—you may dial **1** and immediately enter the option.
- Scroll to **BY NAME**, press **ENTER**.
- Enter **NAME** to search for and press **ENTER**.
- Name is displayed, press **ENTER**, number is displayed.
- Press **SEND** button to automatically call by number.
- Press **MENU** button for more options.
- Press **CANCEL** to enter change and return to Main Configuration Menu—**OR**—press **END** to return to idle screen.

You can also use the Dial by Name feature by following these steps:

- Press the **DIR** button (**DIRECTORY**).
- Select the directory you wish to use: **PERS** (personal speed dial numbers), **SYS** (system speed dial numbers) or **STN** (station names).
- Dial the button on the keypad that corresponds to the first letter of the name you wish to search for.
- Use the **UP** and **DOWN** arrows to scroll through the names.
- Press the **DIAL** soft key to dial the number.

NOTE: A **DIR** button can have an extender to take you directly to one of the above lists (PERS, SYS, or STN).

## CALL PROGRESS DISPLAYS

During everyday call handling, your keyset display will provide information that is helpful and in some cases invaluable. Displays like [CALL FROM 203], [TRANSFER TO 202], [701: RINGING], [TRANSFER FM 203], [708 busy], [Camp on to 204], [Recall from 204], [Call for 501], [message frm 204] and [FWD ALL to 204] keep you informed of what is happening and where you are. In some conditions you are prompted to take an action and in other cases you receive directory information.

## DISPLAY NUMBER DIALED

Display keysets begin showing digits as they are dialed. They will stay in the display until the call duration timer comes on automatically or the **TIMER** button is pressed. If the call duration timer is not used, the number dialed will be displayed until the call is released, transferred or put on hold.

## CALL DURATION TIMER

The system can be set to automatically time outside calls. A few seconds after you dial a telephone number, the timer appears in the display. It appears immediately for incoming calls. The call timer continues for the duration of the call. Call duration times are displayed in minutes and seconds. If a call lasts longer than 60 minutes, the timer restarts.

You can press the **TIMER** button to manually begin timing a call. Press it again to stop timing. If you press it while the automatic timer is on, the call duration time is restarted.

## AUTO TIMER

Display keyset users may have the timer automatically start when they answer incoming calls or after a short delay on an outgoing call.

- With the handset on-hook, press **TRANSFER** and then dial **119**.
- Dial **41** to turn the auto timer on or **40** to turn it off.
- Press **TRANSFER** to store your selection.

## TIMER FUNCTION

Display keyset users may use this feature as a simple stopwatch.

- When the keyset is idle, press the **TIMER** button to start timing.
- Press the **TIMER** button again to stop timing.
- Read the elapsed time in the display.
- Lift the handset and replace it. The display will return to date and time.

## VIEWING MESSAGE INDICATIONS

You can view all of your message indications before you return them:

- With the handset on-hook, press the **MESSAGE** button with the flashing indicator.
- The first station that left a message indication will be displayed.
- Press the **UP** and **DOWN** arrows to scroll through the stations that left message indications. Use the soft keys to reply, clear or advance to the next message.
- Press the **END** button to return your keyset to the idle condition.

## PERSONAL SPEED DIAL NAMES

Each personal speed dial number can have an 11 character name assigned to it. This name is used to select the speed dial bin when you are dialing by directory.

- Press **TRANSFER** and then dial **106**.
- Dial the speed dial bin number **00–49**.
- Write your message using the procedure described in [Alarm Reminder](#).
- Press the **TRANSFER** key to store the speed dial name.
- Repeat for each speed dial bin if necessary.

[See Programming Personal Speed Dial Numbers Section.](#)

## STATION NAMES

[See Application Program Menus—My Phone.](#)

## MANAGING KEY ASSIGNMENTS

You can view your key assignments and add extenders to some of your programmable keys for easy one touch operation of frequently used features.

- While on-hook, press **TRANSFER** and then dial **107**.
- Use the **VOLUME** buttons to scroll through all of your programmable buttons **OR** press the programmable button to which you want to add the extender.
- When you reach a key listed below, dial the corresponding extender.
- Press **TRANSFER** to store and exit programming.

Please refer to the [Enhanced Display Programming Section](#) provided by your installation company when requested for a complete list of descriptions and extenders for any keys you may have programmed on your keyset.

NOTE: Confirm that the cursor is placed correctly before you enter the extender.

## LCR WITH CLEAR

When you are making outside call using LCR and dial an incorrect digit, you can press the **CLEAR** soft key to reenter the telephone number. You do not need to redial 9 to reaccess LCR.

## BACKSPACE WITH LCR

If you misdial while using LCR, you can delete digits shown in the display by pressing the **BACKSPACE** soft key as many times as necessary.

# TEXT MESSAGING

*See also MESSAGE option in the Application Program Menus section.*

This feature allows two digital keyset users to respond to each other with preprogrammed messages. After receiving an Off Hook Voice Announcement or Station Camp-On, you may respond with a text message while continuing to talk and listen to your outside party. The other station can view this message and take the appropriate action or respond back with another text message.

There are 1000 messages assignable to stations in blocks of 10, stored in system memory that can be sent to another display keyset. Only the display keysets that are allowed in system programming (MMC 611) will receive the TEXT MESSAGE soft key in the display and use this feature.

Familiarization with the two digit message numbers you will use the most will make this procedure quick and easy. However if you do not know them, use the **UP/DOWN** button to scroll to the desired message, then press **SEND**.

The basics steps in text messaging are:

1. Press **TEXT MESSAGE** soft key to begin text messaging.
2. Dial the 2 digit number for the desired message.
3. Confirm this is the intended message then press **SEND**.
4. Wait for a reply from the other station (steps 1, 2 & 3)
5. When any station presses **EXIT** the displays at both stations return to their previous call progress condition.

At all times after step 1 you can talk and listen to your caller while repeating steps 2.

The example on the following page will better demonstrate how to use Text Messaging. In this example station 201 is making an off hook voice announcement to station 205 who after hearing the announcement will respond with a text message.

**STATION 201: LINDA**  
received a call on line 702

Talking on line 702

702: 01:15  
CONF PAGE MUTE

Press **TRANSFER**

Transfer:  
RETURN

Dial **205**

205:busy  
OHVA CAMP ON



OHVA to 205

Wait for reply

ASK THEM TO HOLD  
TMSG EXIT



702: 01:45  
CONF PAGE MUTE

**STATION 205: JOHN**  
is talking on line 701

701: 05:25

OHVA from 201  
TMSG REJECT

GIVE THE CALL  
TMSG:01 SEND

Dial **03** or press **↑** twice

ASK THEM TO HOLD  
TMSG:03 SEND



Wait for reply

701: 05:55  
CONF PAGE MUTE

# CALLER ID

## SELECTING YOUR CALLER ID DISPLAY

Simultaneous display of Caller ID name and number on incoming CO calls on both lines of display keysets is supported on all OfficeServ systems. On Transferred CO calls, you can decide if you want to see the Caller ID name or Caller ID number in the display. Regardless of which data is selected, you can press the NND button to view the other pieces of Caller ID information. To select the type of Caller ID information you wish to view:

- With the handset on-hook, press **TRSF** and then dial **119**.
- To set the first line of a ringing call display dial **0**.
- To set the second line of a ringing call display dial **1**.  
Set the data to display from the following:
  - To show nothing dial **0**.
  - To show Caller ID Number dial **1**.
  - To show Caller ID Name dial **2**.
  - To show the DID Number the call came in on dial **3**.
  - To show the Name of the DID the call came in on dial **4**.
  - To show the Name of the Group the call came in for dial **5**.
  - To show the DID Number and then Name of the DID dial **6**.
  - To show the Name of the DID and then the DID Number dial **7**.
- To set the top line of the display shown after answering a call dial **2**.  
Set the data to display from the following:
  - To show Caller ID Number dial **0**.
  - To show Caller ID Name dial **1**.
  - To show the DID Number the call came in on dial **2**.
  - To show the Name of the DID the call came in on dial **3**.
  - To show Caller ID Number and then the DID Number dial **4**.
  - To show Caller ID Name and then the DID Number dial **5**.
  - To show the DID Number and then the name of the DID dial **6**.
  - To show the Name of the DID and then the DID Number dial **7**.
  - To show the C.O. line information dial **8**.
- To set the format if the C.O. line information when the above is set to show C.O. line information dial **3**.
  - To show the C.O. line number and the dialed or Caller ID Number dial **0**.
  - To show only the dialed or Caller ID Number dial **1**.
- Press **TRANSFER** to exit and store your selection.

## VIEWING THE NEXT CALLER ID CALL

In the event that you have a call waiting or a camped-on call at your keyset, you can press the **NEXT** button to display the Caller ID information associated with the call in queue at you keyset. Either the CID name or CID number will show in the display depending on you Name/Number selection.

To view Caller ID information for calls that have been camped-on to your keyset, press the **NEXT** button.

## SAVING THE CALLER ID NUMBER

At any time during an incoming call that provides CID information, you may press the **SAVE** button to save the CID number. The system must be using LCR to dial the saved number.

## REDIALING A SAVED CALLER ID NUMBER

To redial a number that has been saved, press the **SNR** button or dial **17**.

NOTES:

1. Your telephone system must be LCR correctly programmed to redial the saved number.
2. If the Hot Keypad feature has been turned off, you must first lift the handset or press the **SPEAKER** button before you begin.

## STORING A CALLER ID NUMBER

At any time during an incoming call that provides CID information, you may save the CID number as a speed dial number in your personal speed dial list. To store a Caller ID number in a personal speed dial bin:

- Press the **STORE** button. The system displays the speed dial bin in which the number was stored—**OR**—press the **CID** button and then press the **SCROLL** button.
- Press the **STORE** soft key.
- The system displays the speed dial bin in which the number was stored.

NOTE: Your telephone system must have LCR correctly programmed to redial the saved number. If LCR is not being used on your system, you will not be allowed to STORE CID numbers.

## INQUIRE CALLER ID PARK/HOLD INFO

If you are informed that an incoming call is on hold or has been parked for you, you may view the Caller ID information before you retrieve the call. This may influence how you choose to handle the call.

From an idle keyset:

- Press the **INQUIRE** button—**OR**—press the **CID** button and then the **INQUIRE** soft key.
- Dial the trunk number.
- You may now answer the call by pressing the **ANS** button—**OR**—you may use **NND** to view more information about this call—**OR**—you can return to the idle condition by pressing **IGNORE**.

If you are on a call:

- Press the **INQUIRE** button. Your existing call will go on hold—**OR**—press the **CID** button and then the **INQUIRE** soft key to place the first call on hold.
- Dial the trunk number.
- You may now answer the call by pressing the **ANS** button—**OR**—you may use **NND** to view more information about this call—**OR**—you can return to the idle condition by pressing **IGNORE**.

NOTES:

1. If you are on an intercom call or you have Automatic Hold turned off, you must finish the existing call or place it on hold before inquiring.
2. If you inquire about an outgoing call, you will receive a [call no longer available] display.

## REVIEWING PAST CALLER ID CALLS

This feature allows you to review CID information for calls sent to your keyset. This list can contain 10–50 calls in a last-in, first-out basis. The list includes calls that you answered and calls that rang your keyset but that you did not answer (missed calls). When reviewing this list, you can press one button to dial the person back. The system must be using LCR to dial the stored number. To access the CID information stored in your REVIEW list:

- Press the **REVIEW** button—**OR**—press the **CID** button and then press the **REVIEW** soft key.
- If you have entries in your review list, the most recent call will be shown first.
- You can now **CLEAR** this entry—**OR**—use **NND** to view more information about this call, **OR** Press **DIAL** to call this person back—**OR**—press **SCROLL** and then press **STORE** to save this number in a personal speed dial bin.

NOTES:

1. Each keyset defaults with ten review bins. Please see your system administrator to determine the number of bins assigned to your keyset.
2. Your system must have LCR correctly programmed to allow you to **DIAL** numbers from the review list or to **STORE** entries from the review list.

## APPLICATION PROGRAM MENUS

Much of the call processing of the ITP 5112L can be accomplished by using the various feature/function screens on the LCD. Below are instructions for additional call processing and special applications that can be accomplished via the LCD programming. These screens, features and functions can be accessed by pressing the **MENU** button. Follow the below user information to utilize these features and functions.

After pressing the **MENU** button, use the direction button to highlight desired menu icon. For multiple screen options, the UP/DOWN arrows at the top left and right sides of the LCD may be used to scroll on a per page basis. Press **ENTER** to access that menu. To navigate within the menu, you may scroll to the desired option/function, dial the associated option function number or press the associated select button on either side of the display.

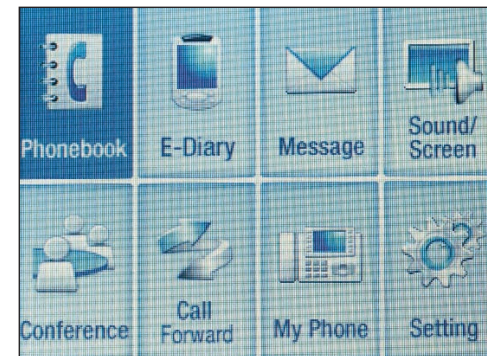

Application Program Main Menu Screen

Press **END** button to exit programming.

## PHONEBOOK

This menu allows you to maintain a contact list of addresses, phone numbers, names, speed numbers and call logs. [Refer to Speed Dialing and Programming Section.](#)

## E-DIARY

1. **WAKE UP CALL:** Set Wake Up call for desired duration (Everyday, Monday-Saturday, Monday-Friday). Using the direction button scroll **UP/DOWN** to the desired option and **LEFT/RIGHT** to scroll to desired option setting.

- Enter **TIME** via dial pad in 24-hour format.
- Set **RING TONE** via direction button (**LEFT/RIGHT**) Each tone is heard.
- Set **REPEAT DURATION** via direction button.
- Press **ENTER** when finished.

2. **ALARM:** [See Alarm Reminder Programming Section.](#)



3. **DAILY PLANNER:** [See Alarm Reminder Programming Section.](#)
4. **MEMO PAD:** Self memo feature. Allows you to set text message notes. Up to 5 memos may be stored.
  - Add **NEW MEMO:** Type in memo on keypad. Press **MENU** button to change fonts or add characters. To save press **ENTER**.
  - When you select an existing **MEMO**, press **MENU** to edit it or delete it.
5. **CALCULATOR**
  - Enter **FIRST NUMBER**, press **NAVIGATION KEY** associated with the proper operation.
  - Enter **SECOND NUMBER** and press **ENTER** to display answer.
6. **WORLD TIME:** Displays times throughout the world.
  - Use direction button, **LEFT/RIGHT** to view desired time zone.
  - Press **MENU** to set your current time zone.
7. **D-DAY PLUS:** Scheduling feature that allows the user to view the time left until an event, or time since event occurred. Use to monitor deadlines, schedules, etc.
8. **UNIT CONVERT:** Weights and Measures conversion application. Allows you to convert units of weights and measures into other units.
  - Choose desired function (**LENGTH, WEIGHT, AREA, VOLUME, TEMPERATURE**), press **ENTER**.
  - Scroll **LEFT/RIGHT** to select base unit.
  - Scroll **DOWN** and **ENTER VALUE** to be converted.
  - Scroll **DOWN**, select **CONVERSION UNIT**.
  - Press **ENTER** to display answer.

## MESSAGE

This menu allows the user to send and receive text messages to/from other ITP-5112L phones and Softphones. The user can also store up to 10 messages on the phone.

### 1. SEND MESSAGE

- a. **SEND MESSAGE:** Select this option to enter and send a new text message. In the "Recv#" field enter the **EXTENSION** of the **RECIPIENT** phone. In the **MSG** box enter your **MESSAGE** and press **ENTER** to send.

- b. **RETRIEVE MESSAGE:** Select this option to **RETRIEVE** a saved message from the Message Box. When selected a list of saved messages will be shown. You can select one of these messages and open it or you can press the **MENU** buttons for deleting, editing or sending.

2. **RECEIVE BOX:** When this item is selected, all incoming text messages will be shown. If you select a received message, then press **MENU**, you can **REPLY**, **RESEND** or **DELETE** the message.
3. **SENT BOX:** This shows a list of sent messages. You can press **MENU** and **RESEND** and **DELETE** messages.
4. **MESSAGE BOX:** This item allows you to save up to 10 messages on your phone. You can send any of these messages at any time. Select "1) Edit Message" to **CREATE** a new message. Select "2) Message List" to **VIEW** and **EDIT** all saved messages. Press **MENU** to **ADD**, **EDIT** or **DELETE** messages.

## SOUND/SCREEN

This option allows the user to set ring tones, volume, and screen settings. Use the directional **ARROW KEYS** to browse and **ENTER** to save.

1. Ring Tone Select: Select from 3 categories of ring tones from your phone.
2. Keytone Select: Selects the tone heard when pressing any button on your phone.
3. Volume: Sets various volume levels on your phone.
4. Select Background: Select the background for your idle screen.
5. Menu Style: Select from 2 menu formats.
6. Background Style: Select from 2 color schemes for your phone menus.
7. Select Brightness: Select screen brightness level.
8. Screen Saver: Determines what time/interval the screen saver or power save will kick in.

## CALL FORWARD

[See Transferring Calls Section, Forwarding Calls.](#)

## SETUP

1. **ANSWERING MODE:** [See Customizing Your Keypad Section, Station Answering Mode Programming.](#)
2. **ABSENT MESSAGE:** [See Paging and Messaging Section.](#)
3. **INTERNAL CALL:** Select incoming information display from internal caller. (Number or Name)

#### 4. AOM PAGE SETUP

5. **DIAL MODE:** Select dial type options. (enblock-requires SEND button to complete the call, or overlap - direct out dial)

- Scroll to or dial **9**, press **ENTER**.
- Scroll **LEFT/RIGHT** to select desired display option.
- Press **ENTER**, display confirms save.

6. **STATION ON/OFF:** Turn the features below on/off in the keyset.

**AUTO HOLD:** Automatically hold the current caller before accessing another trunk or **CALL** key.

**HEADSET USE:** Enable headset mode operation.

**HOT KEYPAD:** Allow dialing from an idle state.

**KEY TONE:** Generate a tone each time a key is pressed on the keyset.

**PAGE REJOIN:** Connect to an in-process page after disconnecting a caller.

**RING PREF:** Allow the user to answer calls by lifting the handset or pressing the speaker button.

**AUTO CAMP-ON:** Automatically camp-on when calling to a busy station.

**AME PASSWORD:** Require a user to enter their AME password to listen to messages as they are being recorded.

**DIS SPDNAME:** Display the Speed Dial bin name instead of the dialed number when calling to a Speed Dial number.

**CID REVIEW ALL:** Store all calls in the CID Review block.

**SECURE OHVA:** Receive Off-Hook Voice Announce (OHVA) audio through the handset.

**AUTO ANS CO:** Automatically answer CO calls when the keyset is set for AUTO ANSWER mode in MMC 103.

**ENBLOCK 2LCD:** Require the user to press SEND to dial the call when 2 LINE ENBLOCK is set to ENABLE in MMC 861.

**STN NO RING:** Do not ring on incoming calls, only flash the CALL/DT/DSS key.

**FEATURE TONE:** Change dial tone to a higher pitch to indicate that a phone status feature is active (DND, Forward All, Station Lock, etc).

**RCV GPU INFO:** Generate a short burst of ring tone when a call rings at another member of the pickup group when PINGRING SERVICE is set to ENABLE in MMC 861.

**MISSED CALLS:** Display a notification of missed calls including number of missed calls and the CID of the most recent call missed.

**USE STN RING:** Allow the user to select a ringtone stored in the keyset instead of a system-generated ringtone.

#### 7. OUT CODE SETUP

8. **NETWORK INFO:** Provides all IP network related information.

## MY PHONE

Used to personalize your keyset.

1. **MY NAME:** Enters the user's name on the phone. The name registered here is displayed on the LCD screen of the opponent's phone when making an internal call.

2. **LANGUAGE:** Sets a language between Korean and English

3. **CHANGE PASSWORD:** Changes the four-digit password that can lock the phone from use.

4. **LOCKED:** Sets the lock status of the phone. This will restrict access to the phone.

- UNLOCKED: Full Access.
- LOCKED OUT: Restricts outgoing calls.
- LOCK ALL: Restricts complete access to phone.

5. **PRIVATE LIFE PROTECTION:** Restricts access to the MENU button using a password.

6. **PHONE VERSION:** Displays the software version of the telephone.

7. **RESET TO DEFAULT:** Removes the data (phone number, messages) set by the user and defaults the phone.

# Samsung Voicemail

This section describes how to setup and use the various features available to a Subscriber. A Subscriber is a person that has been authorized access to the various features and services available in the Samsung Voicemail. Please review this section carefully before you use your Authorized Features and Services, known as Subscriber Services.

Voice Mail is one of the Subscriber Services available. Your voice mail box has the capability of storing private messages, and offers a number of options for sending or redirecting messages as well as provides several ways to notify you of new messages.

Another very common Subscriber Service is Access Manager. This allows you control over when and where you receive your calls as well as what to speak to your callers in the event you are unable to speak to them directly. The 'events' are referred to as "Call Conditions": No-Answer, Busy, and Blocked are the most commonly used Call Conditions.

This guide can be used by Subscribers from within the office or from telephones outside the office. The basic operation is the same, but the access method will be different. [See the Subscriber Services Menu Diagram for more details.](#)

Note that some features and prompts detailed here may not be available to all Subscribers. See your System Administrator if you have questions about feature availability.

## ACCESSING YOUR MAILBOX

*[Also known as Subscriber Services Menu]*

### Inside Callers *[Subscriber logging in from their Desk]*

- Dial the voicemail access number or press the key assigned to ring voicemail **[VMMSG]**.
- Enter your personal password when prompted (the default password is 0000).

### Outside Callers *[Subscribers calling from Cell Phones or outside of the office environment]*

- Dial the phone number that will be answered by the voicemail. The main greeting will answer.
- At the main greeting dial **[#]** plus your Subscriber (or mailbox) number (Subscriber and Mailbox numbers will usually match your extension number).
- Enter your personal password when prompted (the default password is 0000).

### Access your Subscriber Services (or Mailbox) from a Station other than your Own (or checking a mailbox associated with a different station)

- Press the **[VMMSG]** key or dial the voicemail **group number**. You will be prompted to enter a password.
- Press **[\*]**. This will take you to the Main Auto Attendant Menu.
- Press **[#]** plus the Subscriber number of your choice. You will be prompted to enter your password.

At this point the inside and outside callers follow the same instructions. You will hear a message stating the number of messages left in your mailbox. You will then hear the Subscriber Services Menu with the following options:

- 1 Listen to New Messages - [See Listening to your Message.](#)**
  - 2 Record and Send Message - [See Sending Messages.](#)**
  - 3 Review Saved Messages - [See Listening to your Message.](#)**
  - 4 Access Manager - [See Access Manager.](#)**
  - 5 Personal Greetings - [See Personal Greetings.](#)**
  - 6 Mailbox Administration - [See Mailbox Administration.](#)**
- # Personal Services - [See Personal Services.](#)**
- \* Return to Main Menu.**

# Subscriber Services Menu

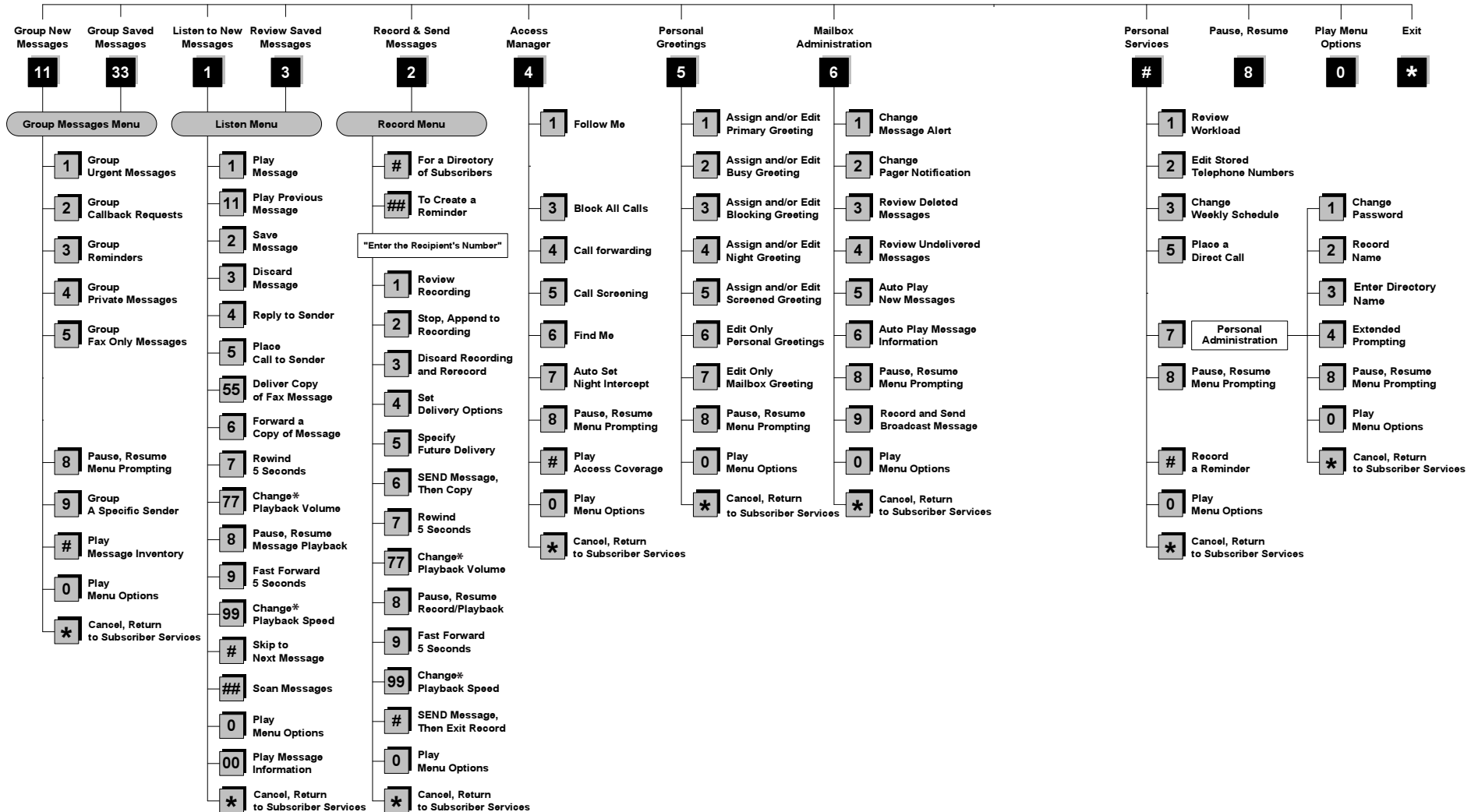

NOTE: All options shown MAY NOT be authorized. If an option is not available please speak to your system administrator.

\*Change Playback Speed and Volume not available on the OfficeServ 7030, OfficeServ 7100, OfficeServ 7200-5 or OfficeServ IP-UMS.

## GETTING STARTED

Using your new Samsung Voicemail Subscriber Services is as simple as following a few simple spoken instructions. First time users should read this section as a tutorial. You should start with the following steps:

- Access your Subscriber Services Menu - You already know how to do this.

### From the Subscriber Services Menu:

- Record a Primary/No-Answer Personal Greeting. Dial **[5][1]**.
- Record a Mailbox Greeting. Dial **[5][7]**.
- Change your access code (Password). Dial **#[7][1]**.
- Record your name. Dial **#[7][2]**.
- Enter your directory name. Dial **#[7][3]**.

After you have completed the steps above your Subscriber Services are set up and ready to use.

## LISTEN TO YOUR MESSAGES

If there are new messages in your mailbox your **[VMMMSG]** key will be lit. Call the Samsung Voicemail by pressing this key, and when prompted enter your password. You will then be at the Subscriber Services Menu. Select **[1]** to listen to new messages or **[3]** to listen to saved messages.

Note: After you enter your password, if "Autoplay of New Messages" is enabled and you have new messages the Samsung Voicemail will begin to play them automatically. A subscriber can control this feature. From the Subscriber Services Menu **[6] [5]** toggles "Autoplay of New Messages" ON/OFF.

## SUBSCRIBER SERVICES MENU

The following is a list of all the options available in the Subscriber Main Menu.

- 1** LISTENING TO NEW MESSAGES
- 11** GROUP NEW MESSAGES
- 2** RECORD AND SEND A MESSAGE
- 3** LISTENING TO OLD MESSAGES
- 33** GROUP OLD MESSAGES
- 4** ACCESS MANAGER
- 5** PERSONAL GREETINGS
- 6** MAILBOX ADMINISTRATION
- 8** PAUSE / RESUME

- 0** PLAY MENU OPTIONS
- \*** EXIT TO AUTO ATTENDANT
- #** PERSONAL SERVICES

## 1 or 3

## LISTENING TO OLD OR NEW MESSAGES

- 1** Play / replay the message you just heard.
- 11** Play the previous message.
- 2** Save the message you just heard and listen to the next message.
- 3** Delete the message you just heard and listen to the next message.
- 4** Reply to the message.  
This will allow you to leave a message in the mailbox of the sender (if the sender has a mailbox on this system).
- 5** Return the call directly to the telephone number that left the message.  
This will work for internal and external callers, but Caller ID service is needed to use this feature on an outside call.
- 55** Deliver a fax copy.  
This will allow you to receive attached faxmail document(s). Faxmail documents can be delivered to any fax machine of your choice as long as out calling is authorized. You can also have faxmail messages automatically delivered to the fax machine of your choice.
- 6** Forward the message and saves a copy.  
The subscriber can be selected by dialing their mailbox number (nnn), using the directory service (#) or you may also add comments and leave it as a memo to yourself (##).  
The Send and Copy Service (option 6) allows a user to send copies of a message to multiple recipients easily. A different introduction message may be left for each recipient.
- 7** Rewind the message 5 seconds.
- 77** Change playback volume of the recording. **[Not available on the OS 7030, OS 7100, OS 7200-S or OS IP-UMS]**  
There are two levels of volume during playback. Dialing this code will toggle between the two levels.
- 8** Pause or resume during message playback.
- 9** Fast forward the message 5 seconds.

- 99** Change playback speed of the recording. **[Not available on OS 7030, OS 7100, OS 7200-S or OS IP-UMS]**

There are two levels of speed during playback. Dialing this code will toggle between the two speeds.

- 0** Play options.  
Pressing this key will play all the menu options available to you from this point.
- 00** Hear the time and date, and sender's information of the message you just heard. Sender information is not available on outside calls.
- #** Move to the next message. This does not Save or Discard the current message - it is retained as new.
- ##** Scan. Plays first 7 seconds of a message then skips to next message. This is similar to the scan button on a radio. It will allow you to find a specific message quickly. To stop scanning press **[1]**.
- \*** Cancel and return to previous menu.

**11** or **33**

## GROUP NEW OR OLD MESSAGES

Messages can be grouped as either Reminders, press **[3]** or Messages from a specific sender, press **[9]**.

Additionally you can press **[#]** and hear a summary of your mailbox contents:

- Number of messages
- Number of reminders
- Number of urgent messages
- Number of messages needing a callback
- Number of private messages
- Number of fax messages

**2**

## RECORD AND SEND A MESSAGE

This option is used to send a message to another subscriber. The steps are simple:

- Enter the recipient's mailbox number, or if this is not known enter **[#]** to use the system directory.

- Record your message at the tone. After recording the message, you will hear the Send Menu with the following functions:

- Review
- Continue Recording
- Discard and Re-Record
- Set Message Attributes (Delivery Options)
- Schedule Future Delivery
- Save and Send then Send a Copy to Someone Else
- # Save and Send the Recording

## Setting Message Attributes

If after recording a message you select **[4]** you can set up any combination of the following delivery options:

- Urgent Delivery
- Return Receipt Requested
- Request a Call Back
- Private Delivery
- Reply Required
- \* Exit

## Scheduling Future Delivery

If after recording a message you select **[5]** to schedule future delivery, you will be able to set message attributes and set this message as:

- Immediate Delivery
- Next Few Hours
- End of Current Business Day (based on your Availability Schedule)
- Beginning of Next Business Day (based on your Availability Schedule)
- A Coming Day of the Week
- Specific Day / Time
- \* Exit

**4**

## ACCESS MANAGER

The Access Manager allows the subscriber to set a number of options for when, where and how, and/or if the Samsung Voicemail contacts you when a caller dials your extension number. All of the options are toggled on/off based on their current status when you access them.

**Note: ALL** Access Manager options **MUST** be individually allowed by the System Administrator for each Subscriber. They are:

### 1 Follow Me

Allows the subscriber to enter an alternate location and set how long the new destination (Designated Location) will be active. This number may be an internal or external number. This is useful if you are frequently traveling or changing the number where you can be reached.

When Follow Me is activated, the transfer will be supervised and confirmed. This means that if the call is not answered or if rejected by the Subscriber at the designated location it will be recalled to the Subscriber's mailbox.

### 3 Call Blocking

When this feature is active, callers will not be transferred to your extension, they will hear your 'blocked' greeting (if recorded) and will go directly to your mailbox if they do not select any or are not offered any other options.

### 4 Call Forwarding

Unlike Follow Me where the subscriber wants to take their calls at an alternate location this feature allows the subscriber to pass control of his calls to another Subscriber. The "Forwarded To" Subscriber will now be in control of the caller and the caller will NOT return to originating Subscriber's Mailbox. If the "Forwarded To" Subscriber does not answer the caller it will now follow what ever the "Forwarded To" Subscriber has set up for their call conditions. The Caller will hear "Forwarding to""{Subscriber Name}" before actually being forwarded.

### 5 Call Screening

If this is turned on, the caller will be asked their name and the Samsung Voicemail will play this name to you before the transfer, giving you an option to accept or reject the call.

### 6 Find Me

Find Me, when enabled, will attempt to locate the subscriber by calling a list of preprogrammed phone numbers. The stored phone numbers are entered in 'Personal Services' [#][2] (if allowed by the Administrator). The stored telephone number list can contain up to 9 preprogrammed telephone numbers. The Find Me feature only use the first five.

### 7 Night Intercept

This feature is dependent on your weekly availability schedule, which is entered in 'Personal Services' [#][3] (if allowed by the Administrator). When Night Intercept is active the Samsung Voicemail will first ring your extension

then play your primary, No Answer greeting during the day (when you are available) and will NOT ring your extension but simply play your Night greeting during the night (when you are not available).

**Note:** This does NOT use the Day and Night schedules of the phone system. It is solely controlled by the Subscriber's Availability Schedule.

### 8 Pause / Resume

### \* Exit from Access Manager

### 0 Play All Options

### # Play Access Coverage

This feature is useful for finding out how you current access settings are set. It will also tell you what greetings will play under each of the call conditions you have setup.

## 5

## PERSONAL GREETINGS

The options available in this menu will be determined by your System Administrator, and not all of them may be available to you. In the simplest systems, only a mailbox greeting will be available, additional greetings may be accessible in more complex systems.

Your Personal Greeting will be played every time someone dials your extension and you do not answer.

You may record up to 9 Personal Greetings, and you may assign any one of them to be active. There are several different 'Call Coverage' conditions to which you may assign any of your 9 greetings. The Call Coverage Conditions are: No-Answer, Busy, and Do Not Disturb (or Forwarded All). This will allow different greetings to play depending on the type of call forward that you have set, or the condition of your telephone.

The Call Coverage conditions that you can assign specific greetings to are selected by the following digits:

### 1 Primary/No Answer Greeting

Used when in your office, away from your desk or during the time period you are scheduled available. If this is the only Personal Greeting you record, it will play for all call coverage conditions.

This option is available only if the Administrator has assigned you the 'Basic Greeting' feature.

Example: "Hi this is John Smith. I'm sorry I am not available to answer your call. If someone else can help you, please enter the extension number now. Or, to leave me a message, press 1."

## 2 Busy Greeting

Played to a caller when you are already talking to someone on your extension or the telephone at your Designated Location.

This option is available only if the Administrator has assigned you the 'Busy Greeting' feature.

Example: "Hi, this is John Smith. I'm on another line right now. If someone else can help you, please enter the extension number now. Or, to leave a message, press 1."

## 3 Call Blocking Greeting

Used while Call Blocking is enabled in your Access Manager or if your phone is forwarded ALL or DND.

This option is available only if the Administrator has assigned you the 'Call Blocking' feature.

Example: "Hi, this is John Smith. Sorry I missed your call, but I'm going to be out of the office for the next few hours. If someone else can help you, please enter the extension number now. Or, to leave me a message, press 1."

## 4 Night Greeting

Used during the time period you are scheduled UNAVAILABLE, usually after business hours during the evening and at night.

This option is available only if the Administrator has assigned you the 'Scheduling' feature.

Example: "Hi, this is John Smith. I've left the office for the evening. If you would like to try someone else, please enter the extension number now. Or, to leave me a message, press 1."

## 5 Call Screening Greeting

Used while Call Screening is enabled, and you REJECT a caller after listening to the caller's record name.

This option is available only if the Administrator has assigned you the 'Call Screening' feature.

Example: "Hi, this is John Smith. I'm sorry, but I am not available to speak with you at this time. If someone else can help you, please enter the extension number now. Or, to leave me a message, press 1."

## 6 Edit Personal Greetings

You may also edit/record each one of the greetings (1-9) at any time.

Select a greeting number to edit and follow the instructions to record your greeting. When you are done recording your greeting, you will be able to listen to the greeting you recorded, save the greeting you recorded and return to the previous menu, record the greeting again, or exit without saving the greeting.

Note: If you record only the greeting assigned to the No-Answer Call Coverage Condition, then that greeting will play to callers for all Call Coverage Conditions (No-Answer, Busy, Blocked, Night, and Rejected Caller). In this case, the salutation part of the greeting should be very general.

## 7 Edit Mailbox Greeting

Used whenever a caller reaches your mailbox or if you have not recorded any of the Call Coverage greetings. The way a caller is transferred to your mailbox greeting directly, is by another subscriber transferring the caller to your mailbox using the VT (VoiceMail Transfer) key.

This option is available only if the Administrator has assigned you the 'Mailbox Greeting Option' feature.

Example: "Hi, this is John Smith. Please leave me a message, I will call you as soon as I can."

Note: This greeting will only play if none of the 5 personal greetings has played to the caller. A common usage for this Greeting is when another Subscriber is talking with a caller and uses the VT key on their phone to transfer the caller directly to your Mailbox.

# 6

## MAILBOX ADMINISTRATION

The Mailbox Administration menu is used to turn on and off your pager notification, message alert options and other message control features.

### 1 Message Alert

When this function is activated, the Samsung Voicemail will call any outside or inside telephone number, after each message is left in your voice mailbox.

To hear your message at the remote location when the Samsung Voicemail calls you, after you pick up the telephone and answer you will be instructed that there is a message and to enter your password. Simply enter your password and you will now be logged in.



### Setting Up Message Alert:

- From the Subscriber Services Menu press **[6]** for Mailbox Administration.
- Press **[1]** for Message Alert.
- There are 4 options available to you:
  - Press **[1]** to toggle message alert on and off.
  - Press **[2]** to set the schedule when you would like to be notified.
  - Press **[3]** to be notified on urgent messages only.
  - Press **[4]** to set the destination phone number.

## 2 Pager Notification

When this function is activated, the Samsung Voicemail will call your beeper service and notify you after each message is left in your voice mailbox.

- From the Subscriber Services Menu press **[6]** for Mailbox Administration.
- Press **[2]** for pager notification.
- There are 4 options available to you:
  - Press **[1]** to toggle pager notification on and off.
  - Press **[2]** to set the schedule when you would like to be paged.
  - Press **[3]** to be notified on urgent messages only.
  - Press **[4]** to set the pager phone number.

## 3 Undelete

When this function is activated, the Samsung Voicemail will allow you to undelete any messages that you have recently deleted (up to the programmed Daily Maintenance Time, which is set to 3 a.m. by Default the following morning).

- From the Subscriber Services Menu press **[6]** for Mailbox Administration.
- Press **[3]** for Deleted Messages.

Deleted voice mail messages are temporarily stored in memory until 3 a.m. the following day. Select this option to recover ("undelete") previously deleted messages, during this period of time.

## 4 Undelivered Retrieval

When this function is activated, the Samsung Voicemail will allow you to recall any messages you have sent that have NOT yet been picked up by the recipient.

- From the Subscriber Services Menu press **[6]** for Mailbox Administration.
- Press **[4]** for Undelivered Messages.

This useful feature will allow you to cancel any messages that have NOT yet been picked up by the recipient.

## 5 Auto Play New Messages

If this option is enabled, after you enter your password correctly any new messages will immediately begin to play. To enable (or if already enabled toggle and disable) this feature:

- From the Subscriber Services Menu press **[6]** for Mailbox Administration.
- Press **[5]** to Set Auto Play of New Messages.

## 6 Auto Play Message Information

If this option is enabled, the date, time and sender's name will be played automatically before each message. If this is disabled, the information must be requested manually by pressing '00'. To enable (or if already enabled toggle and disable) this feature:

- From the Subscriber Services Menu press **[6]** for Mailbox Administration.
- Press **[6]** to Set Auto Play of Message Information.

# 9

## MESSAGE BROADCAST

This option will only be available if it has been allowed by the System Administrator.

### Broadcast to All Mailboxes

If you have been designated as a Subscriber Administrator, you may send a message to ALL mailboxes in the system.

- From the Subscriber Services Menu press **[6]** for Mailbox Administration.
- Press **[9]** for Broadcast Messages.

This option will only be available if your mailbox has been assigned Subscriber Administration privileges.



## PERSONAL SERVICES

The Personal Administration Menu is used to set your password and record your name. Many of these features must be allowed by the System Administrator.

### 1 Workload Management

Allows you to access to all reminders, both Active and Pending. If authorized you can group your reminders as Commitments, Follow-Ups or Tasks for better organization. The system will flag each reminder as Active or Pending (pending means scheduled for future delivery).

### 2 Stored Numbers

Allows you to enter up to 9 stored phone numbers. The first five of these are used in the 'Find Me' feature, but any of them (1-9) can be easily dialed using only one digit followed by the pound key, to be used by many other features from within your subscriber space. (ie: "Follow Me," "Message Alert," "Pager Alert," and "Direct Call").

### 3 Schedule Availability

Allows you to enter a weekly availability schedule for use with Night Personal Greeting and the Auto Night Intercept feature. Follow the spoken directions to enter the days of the week and times you are generally available to talk to your callers. All other times you will be considered unavailable.

### 5 Place a Direct Call

Allows you to place a direct call out of the Samsung Voicemail from anywhere. You may either dial the number or dial a single digit 1-5 that corresponds to a stored number ([See Personal Services, 2 - Stored Numbers](#)). This feature must be authorized by the System Administrator and can be limited or opened to internal, local, and long distance calls.

### 7 Personal Administration

This area is used during the initial set up of your Subscriber Settings ([see next section](#)).

## PERSONAL ADMINISTRATION SETTINGS

This menu allows you to make changes to basic setup settings, that are rarely changed. Use these when you initially set up your personal Subscriber settings. You probably will not need to change them after that.

### 1 Setting your Password

- From the Subscriber Services Menu press **#[7][1]**.
- The current password will be played and you will have the chance to change it.

### 2 Recording your Name

Use this option to record your name. Your recorded name is played in several different situations. It is important to record your name for proper operation of the Samsung Voicemail system.

- From the Subscriber Services Menu press **#[7][2]**.
- The current name will be played and you will have the chance to change it.

Note: It is possible that if you do not record your name and/or enter your Directory Name (described below), you will not be included in the Dial by Name Directory.

### 3 Entering your Directory Name

Use this option to enter your Directory Name. Your Directory Name is used by callers to find you if they do not know your extension number.

- From the Subscriber Services Menu press **#[7][3]**.
- The current Directory Name will be played as a string of digits that are equal to your name spelled out on your telephone keypad. Follow the instructions to enter a new name. You will be prompted to enter your last name and then your first name.

This must be done in order for the directory feature to work correctly.

Note: It is possible that if you do not record your name (described above) and/or enter your Directory Name, you will not be included in the Dial by Name Directory.

### 4 Extended Prompting

Use this option to drastically reduce the number of prompts played in the subscriber interface (mailbox prompts). Change this setting only if you are very familiar with the user operation of the SVMi E-Series.

Note: Remember if you know what digits to press, you can enter them at any time you do not have to wait to be prompted. This feature can be toggled on/off at anytime. Also if it is off you will be prompted within each subscriber menu to press zero for more options. This enables you to still be able to find out what to do if you were to get lost and extended prompting was disabled.

## KEYSET USER FEATURES

The following options are available if you have a display keyset. They require setup by the System Administrator.

### Message Waiting Lights

When new messages are left in your mailbox, the voice mail message light on your keyset will flash. Press this flashing key [**VMMMSG**] and follow the prompts to retrieve messages. This key may be pressed at any time to log into your Subscriber Main Menu.

### Answer Machine Emulation

If you have an Answer Machine Emulation key programmed on your keyset, you can use it to monitor calls going to your voice mail, and optionally answer them. The operation of this feature is similar to screening a call on a home answering machine.

Your keyset must be set to forward on no answer to voice mail. After ringing your station the caller will be connected to your voice mail and hear your personal greeting before leaving a message. During this time you will be monitoring the connection between the caller and your voice mail box. At this time you will only be monitoring the call, you can not talk to the other party until you answer. You may pick up the call at any time or ignore it.

To activate this feature press the **AME** button. The associated indicator will be lit steady. Press again to turn off. If this key is pressed while a station is ringing (during forward no answer), the feature will be turned on for the current call only.

While the caller is leaving a message or ringing you may:

- Press [**#**] to immediately put the caller in your voice mailbox and monitor it.
- Press [**\***] to immediately disconnect your station. The caller continues to leave a message normally.
- Pick up the handset and monitor privately.
- Press **ANS / RLS** to answer the call (using the handset or speaker).

## AME Password

If your keyset has **AME PASSWORD** (MMC 110) set to **YES**, you must enter your station password to listen to messages being left. This will prevent unauthorized people from listening to messages being left for you.

If the password option is turned on, while a message is being left, press the flashing **AME** indicator and enter your station password (not your SVMi E-Series password). You will then hear the message being left.

## Call Record

If you have a call record button assigned to your phone, you may press it at any time, to record the conversation in progress. If you have a display keyset, you will also have the soft key options to pause and time the message.

## SHORTCUTS

### Calling

Calling a station that is busy or does not answer you can press [#] to immediately send the call to the called parties mailbox.

### Call Divert to Voicemail

While receiving an incoming (ringing) call, dial [\*] to immediately send the caller to your personal voicemail box. This will override the call forward no answer setting.

### Direct Messaging

[#] + DSS To make it easy to leave messages for others in your office without having to dial their extension number first, keyset users may simply dial [#] plus a mailbox (extension) number and leave a message directly. If you dial a busy extension press [#] to connect directly with the mailbox.

### Self Memo (Reminder)

Pressing [##] will leave a message in your own mailbox. This is useful to remind yourself of things to do now or in the future. Messages can be sent with future delivery so you can have the system call you when items become due.

## INTERACTIVE DISPLAYS

Display keyset users have the added advantage of using the soft keys and displays to play, save, delete, reply, call, forward, rewind, pause, fast forward, change the volume, get message information, or help.

### Viewing Mailbox Contents

If you have new messages, in addition to the Terminal Status Indicator (TSI) you will be able to use the keyset displays and soft keys to communicate with the SVMi E-Series.

## E-MAIL GATEWAY (EMG)

The E-Mail Gateway feature integrates your voice mail box with your email client. No matter what email client software you are using or where you use it, you can send voice mail messages and fax mail messages to your E-Mail inbox.

There are two parts to the E-Mail Gateway; E-Message Delivery and E-Message Notification.

- E-MESSAGE DELIVERY:** Voice mail messages (.wav) and/or fax mail messages (.tiff) are "delivered" to your Inbox with the appropriate attached file.
- E-MESSAGE NOTIFICATION:** You will receive an e-mail, with NO attachments, notifying you that you have a voice and/or fax mail message in your Voice Mail Box.
  - As a subscriber you can use either E-Message Delivery and/or E-Message Notification.
  - As a subscriber you can have multiple e-mail addresses. (a maximum of 5 valid email addresses).
  - E-Message Notification can be set to one e-mail address while E-Message Delivery is set to different e-mail address.

## Functionality

- With either type of EMG, when Caller ID (CID) is provided, the callers telephone number will appear in the subject field of the email along with the date and time stamp of when the voice message was originally recorded in your Voice Mail Box.
- If the caller is also a subscriber on the system and the E-Mail Gateway is set up with a valid "Reply To" address, the Subscriber's name will also appear in the "From" field. Otherwise, the "From" field will display the name of the Samsung voice mail system (SVMi-8E, SVMi-16E, or SVMi-20E) sending the message.
- Client will use their PC's Multi-Media kit (equipped with either speakers and/or a headset) to listen to messages delivered to their e-mail Inbox.

**IMPORTANT NOTE:** If the PC/Laptop/PDA/Smart Phone/etc... is not equipped with hardware and software capable of playing a '.WAV' file then the E-Mail Gateway will not work for them until they add some method to listen to '.WAV' files delivered to their Inbox.

The same applies to Fax Mail messages, if the device the subscriber is using does not support the viewing of '.TIFF' files, then the E-Mail Gateway for Fax Mail will not work for them until they add some method to view .tiff files delivered to their inbox.

- No Synchronization of messages is performed between the Voice Mail Box and the E-mail Inbox.
  - Messages listened to, forwarded, deleted, and/or saved within an e-mail inbox will NOT effect the status of that same new message in the Voice Mail or the MWI (Message Waiting Indicator) associated with that message on the phone.
  - Also messages listened to in the Voice Mail, from a phone, will not change the Unread/Read status of the same message in an e-mail inbox.

- However, the Voice Mail Administrator can adjust parameters per subscriber or group of subscribers that decide how, when, or if to delete the original voice message after it is sent to the E-Mail Server.
- When full synchronization of messages between Voicemail Box and E-mail Inbox is required, ask your Samsung representative about the OfficeServ IP-UMS. This is an Internet Protocol based fully synchronized Unified Messaging System.

## Benefits

- Store and Archive Voice and Fax Mail Messages in visible folders.
- Voice and Fax Mail Messages can now easily be dragged and dropped into folders the same way e-mail messages are organized and saved.
- Voice and Fax Mail Messages are now essentially the same as any other e-mail message.
- Backups and Message Archives can be made when they are made for all other types of e-mail messages.
- Add text notes and comments to use for reference later.
- Some (if not all) e-mail clients will allow you to edit the body of the e-mail to add comments.
- Some will allow you to edit the subject field to help you find a particular message quickly in a large archive of messages.
- Call Back Numbers and Date & Time Stamp are easily displayed in the Subject field.
- Easily forward Voice messages received, to others even if they are not a Voice Mail Subscriber on your system.
- No EMG System or Client Software to load on your Local PC or Network Servers.

Therefore compatible with most:

- E-Mail providers and E-Mail Clients
- PCs, Laptops, PDA, and/or Smartphones

**NOTE:** If you are not sure you have this functionality on your system and you would like to use it, please contact your on Site system administrator to see if it is available.

## PERSONAL SPEED DIAL NUMBERS

CODE	NAME	TELEPHONE NUMBER
00	_____	_____
01	_____	_____
02	_____	_____
03	_____	_____
04	_____	_____
05	_____	_____
06	_____	_____
07	_____	_____
08	_____	_____
09	_____	_____
10	_____	_____
11	_____	_____
12	_____	_____
13	_____	_____
14	_____	_____
15	_____	_____
16	_____	_____
17	_____	_____
18	_____	_____
19	_____	_____
20	_____	_____
21	_____	_____
22	_____	_____
23	_____	_____
24	_____	_____

# PERSONAL SPEED DIAL NUMBERS

CODE	NAME	TELEPHONE NUMBER
25	_____	_____
26	_____	_____
27	_____	_____
28	_____	_____
29	_____	_____
30	_____	_____
31	_____	_____
32	_____	_____
33	_____	_____
34	_____	_____
35	_____	_____
36	_____	_____
37	_____	_____
38	_____	_____
39	_____	_____
40	_____	_____
41	_____	_____
42	_____	_____
43	_____	_____
44	_____	_____
45	_____	_____
46	_____	_____
47	_____	_____
48	_____	_____
49	_____	_____

## System Feature Codes

### Line Groups

9 Local/LCR  
 800 \_\_\_\_\_  
 801 \_\_\_\_\_  
 802 \_\_\_\_\_

### Station Groups

501 \_\_\_\_\_  
 502 \_\_\_\_\_  
 503 \_\_\_\_\_  
 504 \_\_\_\_\_

### Paging Zones - Dial 55 plus

0 All Internal Zones  
 1 \_\_\_\_\_  
 2 \_\_\_\_\_  
 3 \_\_\_\_\_  
 4 \_\_\_\_\_  
 5 \_\_\_\_\_  
 6 \_\_\_\_\_  
 7 \_\_\_\_\_  
 8 \_\_\_\_\_  
 9 All External Zones  
 \* All External Zones and Internal Zone 0

### Programmed Messages - Dial 48 plus

00 Cancel Message  
 01 In A Meeting  
 02 Out On A Call  
 03 Out To Lunch  
 04 Leave A Message  
 05 Page Me  
 06 Out Of Town  
 07 In Tomorrow  
 08 Return Afternoon  
 09 On Vacation  
 10 Gone Home  
 11 \_\_\_\_\_  
 12 \_\_\_\_\_  
 13 \_\_\_\_\_  
 14 \_\_\_\_\_  
 15 \_\_\_\_\_  
 16\* \_\_\_\_\_  
 17\* \_\_\_\_\_  
 18\* \_\_\_\_\_  
 19\* \_\_\_\_\_  
 20\* \_\_\_\_\_

### Feature Access Codes

10 + xxx Pick Up A Parked Call  
 12 + xxx Pick Up A Held Call  
 13 Door Lock Release  
 16 + xxx Speed Dialing  
 17 Save And Redial Number  
 18 New Call (Recall)  
 19 Last Number Redial  
 400 Cancel Do Not Disturb  
 401 Set Do Not Disturb  
 42 + xxx Cancel Message Wait  
 43 Return Message  
 44 Callback  
 45 Busy Station Camp-On  
 46 Conference  
 47 Account Code  
 48 + xx Programmed Messages  
 49 Send Flash To C.O. or PBX  
 53 + xxx In/Out of Group  
 54 Meet Me Page  
 56 Meet Me Page Answer  
 600 Cancel All Call Forward  
 601 + xxx Set Forward All Calls  
 602 + xxx Set Forward Busy  
 603 + xxx Set Forward No Answer  
 604 + xxx Set Fwd Busy/No Answer  
 605 + xxx Set Forward on DND  
 606 + xxx Set Forward Follow Me  
 65 + xxx Pick Up Ringing Extension  
 66 + xx Group Call Pick Up  
 67 Universal Answer  
 \* Authorization Code

\*Programmed Messages 16-20 not available on OfficeServ 7030, 7100, or 7200-S.



# ITP-5121D IP Keyset User Guide

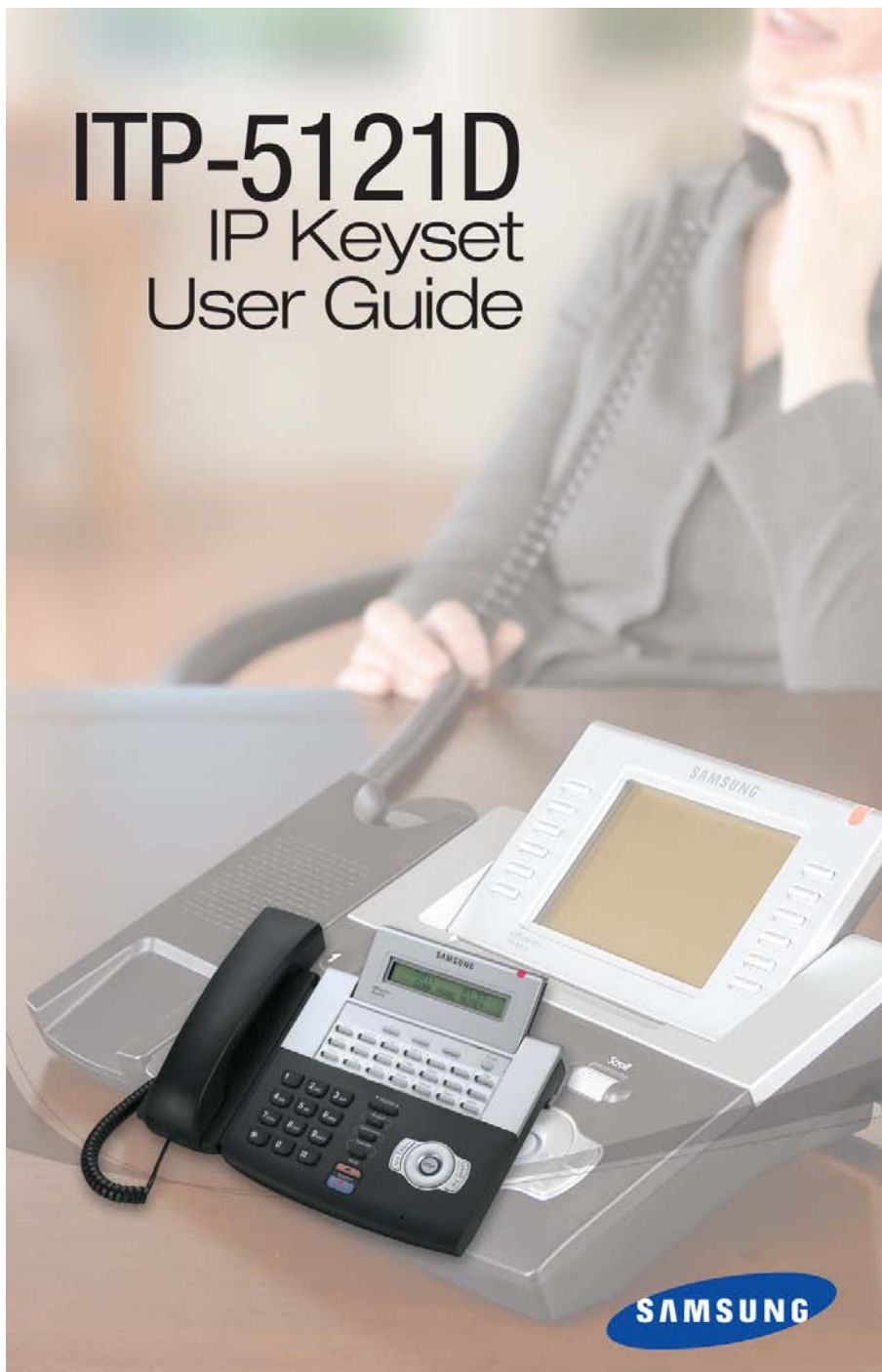

Enterprise IP Solutions

# OfficeServ™

ITP-5121D User Guide

*For OfficeServ™ 100, OfficeServ™ 500,  
OfficeServ™ 7000 Series*

# TABLE OF CONTENTS

<b><u>ABOUT THIS BOOK</u></b> .....	1
<b><u>THINGS YOU SHOULD KNOW</u></b> .....	2–7
<b><u>ASSEMBLING YOUR KEYSET</u></b> .....	8
<b><u>ITP-5121D SETUP</u></b> .....	9–15
<b><u>OUTSIDE CALLS</u></b>	
<u>Making an Outside Call</u> .....	16
<u>Answering an Outside Call</u> .....	16
<u>Universal Answer</u> .....	16
<u>Recall/Flash</u> .....	17
<u>Busy Line Queuing with Callback</u> .....	17
<u>Canceling Callback</u> .....	17
<b><u>INTERCOM CALLS</u></b>	
<u>Calling Other Stations</u> .....	18
<u>Answering Intercom Calls</u> .....	18
<u>Answer Modes</u> .....	18
<u>Busy Station Callback</u> .....	19
<u>Busy Station Camp-on</u> .....	19
<u>Calling Your System Operator</u> .....	20
<b><u>CALL PROCESSING</u></b>	
<u>Holding Calls</u> .....	21–22
<u>Transferring Calls</u> .....	22–23
<u>Transfer with Camp-On</u> .....	23
<u>Transfer to Voicemail</u> .....	23
<u>Call Waiting</u> .....	23
<u>Conference Calls</u> .....	24
<u>Forwarding Calls</u> .....	25–26
<u>Call Pickup</u> .....	27
<u>My Group Pickup</u> .....	27
<u>Privacy Release</u> .....	28

Copyright 2006-2009 Samsung Telecommunications America.

All rights reserved. No part of this manual may be reproduced in any form or by any means—graphic, electronic or mechanical, including recording, taping, photocopying or information retrieval systems—without express written permission of the publisher of this material.

Samsung Telecommunications America reserves the right without prior notice to revise information in this guide for any reason. Samsung Telecommunications America also reserves the right without prior notice to make changes in design or components of equipment as engineering and manufacturing may warrant. Samsung Telecommunications America disclaims all liabilities for damages arising from the erroneous interpretation or use of information presented in this guide.



## **DIALING FEATURES**

Speed Dialing .....	29
Programming Personal Speed Dial Numbers .....	29–30
One Touch Speed Dialing .....	30
Last Number Redial .....	30
Manual Retry with Redial .....	31
Save Number with Redial .....	31
Chain Dialing .....	31
Automatic Redial/Retry .....	31
Pulse to Tone Changeover .....	32
Memo Redialing .....	32

## **PAGING AND MESSAGING**

Making an Internal Page .....	33
Making an External Page .....	33
All Page .....	33
Meet Me Page .....	34
Call Park and Page .....	34
Messages—Set and Cancel .....	35
Returning Messages .....	36
Programmed Messages .....	36

## **CONVENIENCE FEATURES**

Logging In and Out .....	37
Do Not Disturb .....	37
One Time DND .....	37
Mute .....	38
Background Music .....	38
Established Call Pick-Up .....	38
Appointment Reminder/Alarm Clock .....	38
Door Phone Calls .....	39
Executive/Secretary Hotline .....	39
Executive Divert .....	40
Group Listening .....	40
Account Codes .....	40
Locking Your Keypad .....	41
Manual Signalling .....	41
Off-Hook Voice Announce .....	42
OHVA Block .....	42
OHVA Reject .....	43
In Group/Out of Group .....	43

## **CUSTOMIZING YOUR KEYSSET**

AME Password .....	44
Auto Camp-On .....	44
Select Ring Tone .....	44
Change Your Passcode .....	44
Set Answer Mode (Intercom) .....	45
Set Answer Mode (CO) .....	45
Automatic Hold .....	45
Headset Operation .....	45
Hot Keypad .....	46
Key Confirmation Tone .....	46
Rejoining a Page .....	46
Ring Preference .....	46
Auto Answer CO Calls .....	47
Display Speed Dial Name .....	47
Caller ID Review All .....	47
Secure OHVA .....	47
Enblock Dialing .....	48
Configure Mobile Extensions (MOBEX) .....	48–49

## **DISPLAY FEATURES**

Interactive Display Keys .....	50
Directory Information .....	50
Call Log .....	51
Dial by Name .....	51
Call Progress Displays .....	52
Display Number Dialed .....	52
Call Duration Timer .....	52
Auto Timer .....	52
Timer Function .....	52
Viewing Message Indications .....	53
Alarm Reminder Messages .....	53–54
Personal Speed Dial Names .....	54
Station Names .....	54
Managing Key Assignments .....	55
LCR with Clear .....	55
Backspace with LCR .....	55
Text Messaging .....	56–57
Caller ID .....	58–62
ANI .....	59–62
CLI .....	59–62

<b>SPECIAL APPLICATION MENU</b> .....	63
Menu Options.....	63–65
Outgoing Call Log .....	63
Incoming Call Log .....	63
Speed Dial.....	64
Directory Dial .....	64
Forward Set .....	64
Alarm Reminder .....	65
<b>Samsung Voicemail</b> .....	66
Accessing your Mailbox .....	67
Subscriber Services Menu Diagram .....	68–69
Getting Started .....	70
Listen to your Messages .....	70
Subscriber Services Menu .....	70
Listening to Old or New Messages .....	71
Group New or Old Messages .....	72
Record and Send a Message .....	72–73
Access Manager .....	73–75
Personal Greetings .....	75
Mailbox Administration .....	77
Message Broadcast .....	79
Personal Services .....	80
Personal Administration Settings .....	81
Keypad User Features .....	82
Shortcuts .....	84
Interactive Displays .....	84
E-Mail Gateway (EMG) .....	84–86
<b>PERSONAL SPEED DIAL NUMBERS</b> .....	87–88

## ABOUT THIS BOOK

Samsung's new OfficeServ Technology keyset model, ITP-5121D, is part of the OfficeServ 100, OfficeServ 500, and OfficeServ 7000 Series.

The ITP-5121D IP keyset represents a new concept of Internet phone, in that it uses an IP address to Send/Receive voice and data. For voice communications, the ITP-5121D uses the data network line already in place in most offices and increasing number of homes.

The ITP-5121D keysets incorporate an LCD screen, which provides important information for the user, to make using the keyset easier and more convenient.

Your keyset is the most visible part of your telephone system. Please take the time to study this guide and to become familiar with the operation of your keyset. Keep this guide handy, as you may need to look up instructions for infrequently used features.

Learning to use your keyset correctly will make everyday telephone communications a breeze.

This book is written based on the factory default settings for the feature access codes. Sometimes, due to programming requirements, these codes may be changed. If you find that a feature code does not work as described in this book, please contact your installation and service company to determine the correct code.

# THINGS YOU SHOULD KNOW

## USER ORIENTATION

The ITP model telephones are called IP keysets. The IP keyset incorporates buttons or “keys” that are used to access or activate the many features of your office phone system. The ITP-5121D keyset incorporates 21 programmable buttons. These 21 buttons are arranged in three rows of seven across the face of the keyset. Any of the system features or functions can be programmed to these buttons.

The three buttons above the top row of programmable buttons are soft keys. These buttons assist in the use of the system features and functions.

Lines from the telephone company are “C.O. lines.” Calls on these lines are referred to as “outside calls.” Your system can have individual C.O. line keys or lines may be assigned to groups. When they are in a group, you access a line by dialing an access code or pressing a route button. For example, dial 9 or press a “LOCAL” button to get a local outside line. If Least Cost Routing is used, pressing the “LCR” button will automatically select a preprogrammed C.O. line according to what digits are dialed. Each line in the system is numbered, beginning with 701, then 702, 703, etc.

Direct Station Selection (DSS) buttons are programmed to ring specific stations. You can press a DSS button instead of dialing the extension number.

## CALL INDICATIONS

The buttons on your phone have light emitting diodes (LEDs). These are tri-colored LEDs that light green, red or amber (green and red together).

Intercom calls, also called internal calls, always appear on your CALL buttons. They will always light green. You can have up to eight CALL buttons, but at least two are recommended.

Outside calls appear on individual line buttons if they are assigned. When an individual line is not assigned to its own button, it will appear on a CALL button.

Your outside calls will light green on your keyset and red on other keysets. You never lose sight of your calls while they are on hold. They stay right where you put them and are identified with a green flashing light.

Some simple rules to remember:

- Any steady LED indicates the line or feature is in use.
- A fast flashing green LED indicates a new call ringing in.
- A slow flashing green or red LED indicates a call is on hold.
- A slow flashing amber LED indicates a recall to your keyset.

## FULL DUPLEX SPEAKERPHONE

All ITP keysets are speakerphones. Pressing the **SEND** button will answer an incoming call on the speakerphone. Pressing the **END** button will release the call on the speakerphone.

Switching from the handset to the speakerphone is easy. Simply press the **SPEAKER** button and hang up the handset.

## VOLUME CONTROLS

The ITP-5121D keyset uses the **UP** and **DOWN** buttons to adjust the ringer volume while the keyset is ringing, the speaker volume while the speakerphone is in use and the handset volume while you are listening. These three levels will be stored in memory until changed. If background music is turned on at your keyset, the volume buttons will also control the level of music. The volume of pages heard through the speaker of a keyset can be adjusted during a page announcement by using the volume buttons. There are 16 levels for each volume setting. The volume of off-hook ring is controlled by a user-programmable setting.

## TERMINAL STATUS INDICATOR

The terminal status indicator light is positioned on the top right corner of the keyset above the display. The terminal status indicator is a tri-colored (red, green, and amber) light that provides greater visibility of your keysets status than the individual button LEDs. The terminal status indicator provides the following indications:

- |                     |                                      |
|---------------------|--------------------------------------|
| • Busy/Off Hook     | Steady Red                           |
| • Intercom Ring     | Flashing Red                         |
| • Outside Call Ring | Flashing Green                       |
| • Recall Ring       | Flashing Amber                       |
| • Message Waiting   | Flashing Red                         |
| • Do Not Disturb    | Fast Flash Red at 1 Second Intervals |

## CONFERENCE BUTTON

The **CONFERENCE** button allows the user to set up a call with up to 5 parties (station or trunk).

## TRANSFER BUTTON

Transfer is used to send any call to another extension in one of two ways. You can do a screened transfer by informing the other extension who is calling or you can do a blind transfer without notification.

## HOLD BUTTON

The **HOLD** button maintains the call at your keyset, while enabling you to call other stations or consult coworkers in confidence.

## SPEAKER BUTTON

The **SPEAKER** button allows you to have a conversation from the keyset without lifting the handset.

## NAVIGATION BUTTON

The ITP-5121D keyset incorporates a **NAVIGATION** button. This button is designed to assist the user in activating and using various station features, more easily. These features include:

- Outgoing Call Log
- Incoming Call Log
- Speed Number Search
- Name Search
- Call Forward Assign
- Alarm Assign

With the **NAVIGATION** button the station user is no longer required to enter station level programming to activate these frequently used features. A few button presses and these features are activated.

The **NAVIGATION** button is divided into separate feature buttons. These buttons are described below.

- **MENU BUTTON:** This button displays the station feature main menu so that the users can easily utilize various settings and helpful functions.

- **SEND BUTTON:** If the station is programmed for **Enblok Dial Mode**, when dialing an outside telephone number or internal station number, you must press the **SEND** button to initiate the call. This button is also used when reviewing recently received or called numbers and answering incoming calls.

When reviewing recently received calls, continue to press the **SEND** button for more than 2 seconds and the last outside number called will be redialed.

The **SEND** button operates as the **ANS** portion of the **ANS/RLS** button. An **ANS/RLS** button may be assigned to the station as a programmable button.

- **ENTER BUTTON:** This button is used to select a menu option, or to save changes made to a menu or submenu option.
- **DIRECTION BUTTON:** The **DIRECTION BUTTON** is the donut shaped ring, which surrounds the **ENTER** button. This button is used to navigate within the menus. There are directional arrows stenciled into this button, which indicate which direction the cursor will be moved.
- **END BUTTON:** This button is used to disconnect a call after a conversation or to move to the initial screen.  
The **END** button operates as the **RLS** portion of the **ANS/RLS** button. An **ANS/RLS** button may be assigned to the station as a programmable button.
- **CANCEL BUTTON:** This button is used to erase any characters or numbers entered by the dial pad or to move to the previous screen.

## FEATURE ACCESS CODES

This user guide is written based on the default access code for using system features. If the system numbering plan has been changed some of the access codes may not be correct. Your installing company can inform you of the correct codes.

# SYSTEM TONES

The system provides several tones to assist you. Some of these tones are already familiar to you.

Intercom Dial Tone—A steady tone that indicates you can begin dialing.

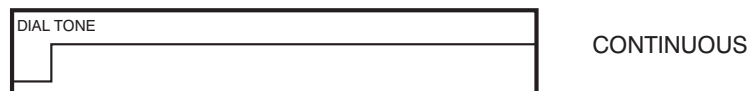

Ringback Tone—Indicates the station you dialed is ringing.



Busy Tone—Indicates the station you dialed is busy.



DND/No More Calls Tone—Fast busy tone indicates the station you dialed is in the Do Not Disturb mode or cannot receive any more calls.

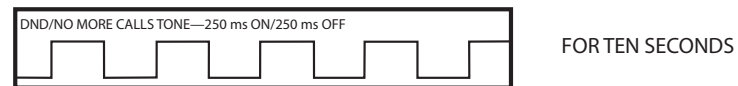

Transfer/Conference Tone—Indicates your call is being held and you can dial another party.

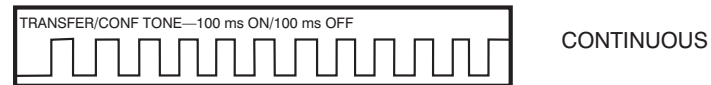

Confirmation Tone—Very short beeps followed by dial tone indicate you have correctly set or canceled a system feature.



Error Tone—A distinctive two level beeping tone indicates you have done something incorrectly. Try again.



# ITP-5121D

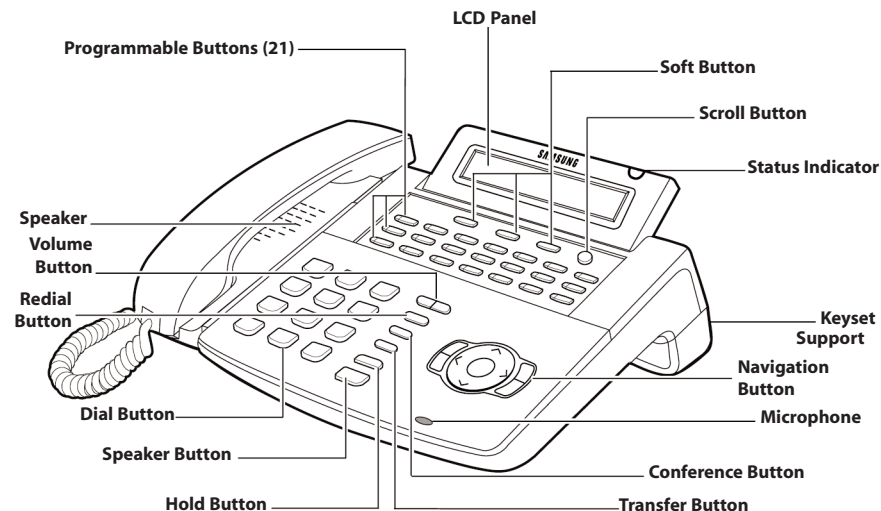

# ASSEMBLING YOUR KEYSSET

- Place the keyset face down on a flat surface.
- Insert notched ends of the support bracket into the channels located in the upper section of the bottom panel. Push towards the top of the keyset to lock in.
- Plug the handset cord into the jack marked with the  symbol.
- Route the handset cord out the **RIGHT** side of the keyset as you look at it face down.
- Plug an eight-conductor ethernet cable, from the wall, into the jack marked **LAN** on the back of the keyset. (Connect the ITP keyset to any port on the local network).
- If your ITP will share LAN connection with a PC, plug an eight-conductor ethernet cable, from the PC, into the jack marked **PC** on the back of the keyset.
- Plug the power connector, from the power adapter provided, into the power jack on the back of the keyset. The power adapter is not required if the ITP is connected to a LAN connection that provides power over the ethernet. The ITP-5121D supports the power over ethernet feature when it is connected to a IEEE 802.3af compliant LAN switch or power injector port.

## IMPORTANT NOTE:

- Be careful not to connect the Network LAN cable into the PC connector of the phone.
- To prevent damaging the keyset, only use the Power Adapter that came with the 5121D keyset.
- This manual assumes that the ITP keysets are connected to a functioning local IP network. The local IP network must be able to communicate with the main processor and MGI channel in the OfficeServ 100, OfficeServ 500, or in the OfficeServ 7000 Series systems over IP. This is assumed regardless of whether the IP keyset is on a local or remote network.

# ITP-5121D SETUP

## INITIALIZING THE ITP-5121D

Initially the ITP-5121D IP keyset will need to be setup to operate within the users network. The Setup Menu is also used to make changes to the keyset, in the event that the system information should change. The option chosen via scroll key will be highlighted.

The station numbers will be automatically set by the OfficeServ 100, OfficeServ 500, and the OfficeServ 7000 Series systems once the necessary information has been entered into the IP keyset. Enter ID and password of the server, as described below to register the phone.

See your system administrator for specific Network and Server addresses. The addresses necessary to set up the ITP-5121D are:

- IP Address of the ITP
- Network Gateway Address
- Subnet Mask
- IP Address of System's main processor
- User ID
- Password

To get to the Set-Up Menu, unplug the power from the ITP-5121D phone or unplug the LAN cable if using Power over Ethernet, press and hold the **MENU** button while plugging in the power cord or LAN cable if using Power over Ethernet back into the phone. Now release the **MENU** button.

>1. SYSTEM EASY WIZARD  
2. SYSTEM INFORMATION

Other items not shown on screen when scrolling down (press down arrow on navigation disc).

3. NETWORK SETUP  
4. LOAD & UPGRADE SETUP

5. SYSTEM SERVER SETUP  
6. PHONE SETUP

6. PHONE SETUP  
7. FACTORY RESET

7. FACTORY RESET  
8. REBOOT

## IP SETUP MENU

To enter the **IP SETUP MENU**, press the **MENU** button as soon as the ITP-5121D phone is connected to the power supply or Power over Ethernet LAN port.

When entering the IP setup menu, the LCD displays the following options:

>1. SYSTEM EASY WIZARD  
2. SYSTEM INFORMATION

Other items not shown on screen when scrolling down (press down on navigation disc):

3. NETWORK SETUP  
4. LOAD & UPGRADE SETUP

5. SYSTEM SERVER SETUP  
6. PHONE SETUP

6. PHONE SETUP  
7. FACTORY RESET

7. FACTORY RESET  
8. REBOOT

Once the **IP SETUP MENU** is displayed, you can move to each menu in the Set Up by using the navigation buttons.

- The **UP** and **DOWN** directions buttons in the navigation button assembly are used to move the highlighted bar up or down to the desired option.
- The **LEFT** and **RIGHT** buttons in the navigation button assembly are used to move the highlighted bar left or right, to the desired option, move to a sub menu and if a menu is at the last line, that menu option will be executed.
- The **[0]-[9]** dial buttons are used to directly choose a menu, or sub menu options.
- The **[ENTER]** button in the navigation button assembly is used when saving a modification.
- The **[MENU]** button in the navigation button assembly is used to display the IP Setup Main Menu.
- The **[END]** button in the navigation button assembly is used when canceling or editing the modification, or existing programming.
- The **[CANCEL]** button in the navigation button assembly is used to go back to the previous screen or to delete the last digit of a displayed option value.

## MENU STRUCTURE

The IP SETUP MENU is configured as follows:

### 1. SYSTEM EASY WIZARD

This option will guide you through setting up all required parameters for connecting the ITP keyset to your system.

### 2. SYSTEM INFORMATION

1. Version Info: Provides boot rom, software, DSP, and hardware version information.
2. Network Info: Displays network mode, IP address of phone, network, and gateway information.
3. Netmask
4. Gateway

Note that items 2 to 4 are only displayed when setting Manual IP.

### 3. NETWORK SETUP

This menu allows you to individually setup the same parameters found in the Easy Wizard.

### 4. LOAD & UPGRADE SETUP

1. Upgrade TFTP Server: The IP address of the TFTP server containing the ITP software.
2. Upgrade Start: Starts the ITP software upgrade process.

### 5. SYSTEM SERVER SETUP

1. Server IP Address: The main processor's IP address.
2. Server ID: The ID assigned to your ITP (see your phone administrator for this information).
3. Server Pass: The password assigned to your ITP (see your phone administrator for this information).

### 6. PHONE SETUP

1. Idle Mode: Allow or Deny access to the Hot Desking (Idle Login) feature.

### 7. FACTORY RESET

This option resets ITP to factory default settings.

### 8. REBOOT

This option reboots the ITP.

## NAVIGATING THE MENUS

When programming within various menu options, information can be entered via the dial pad keys using [0]-[9] and [\*] dial keys, as well as utilizing the navigation button assembly.

The button used for editing and their features are summarized below.

BUTTON	FEATURES
Left and Right .....	To move a cursor (highlighted area) or to erase what is entered.
Enter .....	To save the current setting and end programming.
End.....	To cancel the current programming and return to the Main Menu.
Cancel.....	To move back to the previous screen or delete the last digit of the displayed option value.
[*] .....	To enter [,] between IP address fields.
[0]-[9] .....	To enter numerical values.

## SETTING HOT DESKING (IDLE LOGIN)

Hot Desking allows you to log in and out of your ITP-5121D without rebooting.

- From the Main Menu, select [**6. PHONE SETUP**] to turn Hot Desking on or off.

6. PHONE SETUP

- Select [**1. IDLE MODE**].

1. IDLE MODE

- Enter **1** to **allow** Hot Desking, Enter **0** to **deny** Hot Desking.

IDLE MODE En(1)/Di s(0)  
0\_

- Press **ENTER**.
- Press **END**.

## SETTING THE NETWORK PARAMETERS

Utilize the following programming steps to program the ITP-5121D keyset to operate within the users network.

### Network Parameter Setup

From the Setup, Main Menu, select [**3. NETWORK SETUP**] to set or modify the network parameters.

3. NETWORK MODE SET UP

Select the **Network Mode Setup** and press **ENTER**, the LCD will display this message.

>1. MANUAL IP  
2. DHCP

- If [**1. MANUAL IP**] is selected, the user must enter the IP address of the IP keyset. Then enter the subnet mask, and gateway value for the customer network.
- If [**2. DHCP**] is selected, the IP address, subnet mask, and gateway value will be obtained automatically (if a DHCP server is present).

### Setting IP Manually

- From the "Network Mode Setup" Menu, select [**1. MANUAL IP**] and press **ENTER**. Next, press the **END** button to get to the **NETWORK SETUP MENU** as seen here.

1. NETWORK MODE SET UP  
2. IP ADDRESS SET UP

3. NETMASK SETUP  
4. GATEWAY SETUP

Enter the IP address of the IP keyset. Next, enter the netmask and gateway address for the customer network.

- If the [**2. IP ADDRESS SET UP**] menu is selected, press **ENTER**, the LCD will display this message and the user can enter its IP address.

INPUT IP ADDRESS & PRESS OK  
xxx. xxx. xxx. xxx

Check if there is any currently saved IP address of the phone on the LCD. If the IP address has not been set, the LCD displays nothing. The user can enter the IP address using [0]-[9] dial buttons and [\*] button for entering a "." Save that IP address by pressing the [Enter] button of navigation button assembly.

- If the [**3. NETMASK SET UP**] menu is selected, press **ENTER**, the LCD will display the following message and the user can enter a new Netmask IP address.

INPUT NETMASK & PRESS OK  
xxx. xxx. xxx. xxx



Check if there is any currently saved subnet mask address of the phone on the LCD. If the subnet mask address has not been set, the display will show nothing. Press any dial buttons from [0]-[9] and [\*] button to enter the subnet mask IP address and then save that subnet mask IP address by pressing the [Enter] button of navigation button assembly.

- If the [4. GATEWAY SET UP] menu is selected, press **ENTER**, the LCD will display the following message and the user can enter a new gateway address.

INPUT GATEWAY & PRESS OK  
xxx. xxx. xxx. xxx

Check if there is any currently saved Gateway IP address of the phone on the LCD. If the gateway IP address has not been set, the LCD displays nothing. The user can enter the gateway IP address by using [0]-[9] and [\*] button and can save that IP address by pressing the [ENTER] button of the navigation button assembly.

NOTE: In the [3. NETWORK SET UP MENU], [1. NETWORK MODE SETUP] option, when [2. DHCP] is selected the IP address, Netmask, and Gateway will not be displayed on the LCD.

## Load and Upgrade Set/Modify

The fourth item [4. LOAD & UPGRADE SET UP] sets or modifies the IP phone's software version. Use extreme caution when upgrading the keyset.

Select the [4. LOAD & UPGRADE SET UP] item and move to the lower level. The screen below is displayed.

1. UPGRADE TFTP SERVER  
2. UPGRADE START

Select option [1. UPGRADE TFTP SERVER] and enter the IP address of the TFTP server containing the ITP software. Use [0]-[9] and [\*] button to enter the IP address. Press ENTER to save.

Select option [2. UPGRADE START] to start the upgrade process.

## System Server Setup

The fifth item [5. SYSTEM SERVER SET UP] sets or modifies settings related to registering the phone to the main processor. You can obtain this information from your system administrator. The screen below is displayed.

1. SERVER IP ADDRESS

You can set/modify the IP address of the main processor at the [1. SERVER IP ADDRESS] item. The screen below is displayed when you enter the item. The server IP is the IP address of the main processor.

INPUT SERVER IP ADDRESS  
xxx. xxx. xxx. xxx

You can confirm the current IP address of the main processor at the LCD panel. The address is left blank if it is not set. Use the dial buttons from [0]-[9], and [\*] to set the IP address and press the [ENTER] button among the navigation buttons to save and exit. Select the [2. SERVER ID] item.

\* INPUT SYSTEM ID  
xxxx

You must input the ID assigned to your ITP phone. See your phone system administrator to get this value. Press the [ENTER] button to save and exit. Select the [3. SERVER PASS] item.

\* INPUT SYSTEM PASSWORD  
xxxx

You must input the password associated with your ID. See your phone system administrator to get this value. Press the [ENTER] button to save and exit.

## Completion of Settings

From the main menu, select the seventh item [7. REBOOT] to save all modified settings and reboot the ITP-5121D phone.

# OUTSIDE CALLS

## MAKING AN OUTSIDE CALL

- Lift the handset and press an idle outside line button, line group button or dial a line access code to receive dial tone—**OR**—press an idle outside line button, line group button or dial a line access code to receive dial tone through the speaker—**OR**—press **SPEAKER**, receive intercom dial tone and dial a line access code.
- Dial the telephone number.
- Finish the call by replacing the handset or pressing the **END** button.

NOTE: You will receive No More Calls tone when you attempt to make a call and there is no button available for that line.

- If Least Cost Routing is enabled on your phone system, this button may be labeled **LCR** or accessed by dialing an access code (usually **9**).
- If your system is programmed to require an authorization code before making a call, dial **\*** plus a valid code before selecting a C.O. line.
- If your system is programmed to require an account code before making a call, press the **ACC** button or dial **47** plus a valid bin number, press the **ACC** button again, or **\***, and then select a C.O. line. [See Account Codes for more information.](#)

For more information on authorization and account codes, see your system administrator.

NOTE: If the Hot Keypad feature has been turned off, you must first lift the handset or press the **SPEAKER** button before dialing.

## ANSWERING AN OUTSIDE CALL

- Lift the handset and you are automatically connected to the ringing call. [See Ring Preference under Customizing Your Keypad](#)—**OR**—press the **SEND** button to automatically answer on the speakerphone.

NOTE: If a call is flashing at your keyset but not ringing, you must press the flashing button to answer.

## UNIVERSAL ANSWER

Outside lines may be programmed to ring a general alerting device. To answer calls ringing this device, dial **67** or press the **UA** button. This device can operate in any one of the six different ring plans.

NOTE: If the Hot Keypad feature has been turned off, you must first lift the handset or press the **SPEAKER** button before dialing.

## RECALL DIAL TONE

Press the **NEW** button to disconnect your existing call, wait for dial tone and then make a new call on the same line.

NOTE: If this button does not appear on your keyset, the **FLASH** button may be programmed to recall dial tone.

## SENDING A FLASH

While on an outside call, press the **FLASH** button to send a flash to the telephone company. This is required for some custom calling features or CENTREX use.

NOTE: Flash is not available on an ISDN circuit.

## BUSY LINE QUEUING WITH CALLBACK

If you receive a busy signal when you are selecting an outside line, this means that the line or group of lines is busy.

- Press the **CBK** button, if programmed, or dial **44**. You will hear confirmation tone.
- When the line becomes free, the system will call you back.
- Lift the handset or press the **SEND** button to answer, wait for dial tone and dial the telephone number or speed dial number again.

NOTES:

1. A callback will be canceled if not answered within 30 seconds. If you have set a callback, your **CBK** button will light.
2. If the Hot Keypad feature has been turned off, you must first lift the handset or press the **SPEAKER** button before dialing.

## CANCELING CALLBACK

A callback will be canceled if not answered within 30 seconds. If you have set a callback, your **CBK** button will light.

Your phone may have a maximum of five callbacks to lines and/or stations set at a time. To cancel a callback:

- Press the **CBK** button, if programmed, or dial **44**. You will hear confirmation tone.
- While you are listening to confirmation tone, press the **HOLD** button. This will cancel the oldest set callback.

NOTE: If the hot keypad feature is turned off, you must first lift the handset or press the **SPEAKER** button before dialing.

# INTERCOM CALLS

## CALLING OTHER STATIONS

- Dial the extension number or group number.
- Wait for the party to answer. If you hear a brief tone burst instead of ringback tone, the station you called is set for Voice Announce or Auto Answer. Begin speaking immediately after the tone.
- Finish the call by replacing the handset or press the **END** button.

### NOTES:

1. If you have a **DSS** button assigned to an extension or station group, you may press this button instead of dialing the number.
2. If the Hot Keypad feature has been turned off, you must first lift the handset or press the **SPEAKER** button before you begin dialing.

## ANSWERING INTERCOM CALLS

- When your keyset rings, simply lift the handset—**OR**—press the **SEND** button to be connected to the calling station.
- To finish the call, replace the handset or press the **END** button.

[See Ring Preference under Customizing Your Keypad.](#)

## VOICE ANNOUNCE MODE

When another station calls you, your keyset will sound a brief attention tone and you will hear the caller's announcement.

- Press **SEND** to turn on the microphone and speak handsfree—**OR**— lift the handset to reply.
- To finish the call, replace the handset or press the **END** button.

NOTE: In order for C.O. calls to be answered handsfree, AUTO ANS CO must be set ON.

## AUTO ANSWER MODE

When another station calls you, your keyset will sound a brief attention tone and then automatically answer the call.

- Your microphone and speaker are turned on and you can speak handsfree. For privacy, use the handset.
- To finish the call, replace the handset or press the **END** button.

NOTE: In order for C.O. calls to be answered handsfree, AUTO ANS CO must be set ON.

## BUSY STATION CALLBACK

When you call another station and receive a busy signal:

- Press the **CBK** button, if programmed, or dial **44**.
- When the busy station becomes free, your keyset will ring.
- Lift the handset or press **SEND** to call the now idle station.

### NOTES:

1. A callback will be canceled if not answered within 30 seconds. If you have set a callback, your **CBK** button will light.
2. If the Hot Keypad feature has been turned off, you must first lift the handset or press the **SPEAKER** button before dialing.

## BUSY STATION CAMP-ON

When you call another station and receive a busy signal but you do not want to wait for a callback:

### MANUAL CAMP-ON

- Press the **CAMP** button or dial **45**.
- The called station will receive off-hook ring tone repeated every few seconds and its first available **CALL** button will flash green to indicate your call is waiting.
- Wait for the called party to answer.
- The called station must release its first call or place it on hold before answering your camp-on.

### NOTES:

1. If you receive No More Calls tone, that station has no available button to accept your call. Hang up or leave a message.
2. If the Hot Keypad feature has been turned off, you must first lift the handset or press the **SPEAKER** button before dialing.

### AUTO CAMP-ON

When you want to automatically camp on to a busy station without pressing the camp on button every time you call a busy station, you can set your phone for auto camp-on.

- With the handset on-hook, press **TRANSFER** and then dial **110**.
- Dial **081** to turn on auto camp-on or **080** to turn it off.
- Press **TRANSFER** to store your selection.

## CALLING YOUR SYSTEM OPERATOR

- Dial **0** to call your system operator or group of operators.
- If you want to call a specific operator, dial that person's extension number.

NOTE: If the Hot Keypad feature has been turned off, you must first lift the handset or press the **SPEAKER** button before you begin dialing.

## CALL PROCESSING

### SYSTEM HOLD

- When you are connected to any call, press **HOLD**. The call will flash green at your keyset. If this call appears on a line button at other keysets, it will flash red at those keysets.
- To take the caller off hold, press that button and the green flashing light will go steady green again. Resume the conversation.

NOTE: While on a call, pressing a line button, route button or flashing **CALL** button will automatically put your first call on hold and connect you to the new call. [See Automatic Hold under Customizing Your Keypad.](#)

### EXCLUSIVE HOLD

To place an outside call on hold at your phone so that other users cannot get it:

- Press the **HOLD** button twice. The call will flash green on your keyset and this line will show a steady red light on other keysets.
- To retrieve the call, press the flashing green line button or press the **HOLD** button a third time.

NOTE: Intercom calls will always be placed on exclusive hold.

### REMOTE HOLD

When you wish to place a call on hold at another station. Press **TRANSFER** and dial the station number (or press the appropriate DSS button). Press the **HOLD** button. This will place the call on system hold on an available CALL button or Line Button at the remote station and return you to dial tone.

NOTES:

1. If the destination station does not have any free CALL buttons or line buttons you will hear No More Calls tone and must return to the other party by pressing the **TRANSFER** button (or the RETURN soft key in the display).
2. Intercom calls cannot be remote held.

### HOLD RECALL

If you leave a call on hold longer than the hold timer, it will recall your station. The button that the call appears on will have a slow flashing amber light.

- When your phone rings, lift the handset or press the **SEND** button to answer the recall.

- If you do not answer this recall within a pre-programmed period of time, it will go to the system operator.

## CONSULTATION HOLD

When you are talking on an outside line and it is necessary to consult with another extension:

- Press the **TRANSFER** button; you will receive transfer dial tone. Your call is placed on transfer hold.
- Dial the extension number.
- Consult with the internal party.
- Press **TRANSFER** to return to the outside party or hang up to transfer the call.

NOTE: Repeatedly pressing the **TRANSFER** button will toggle between the outside party and internal extension. If necessary you may disconnect either one of the parties by pressing the **DROP** button.

## RETRIEVING CALLS HELD AT ANOTHER STATION

When a line is on hold and it appears on your keyset, press the line button with the red flashing light.

When a line is on hold and it does not appear on your keyset, dial **12** plus the line number or the extension number of the station that placed the call on hold.

NOTE: If the Hot Keypad feature has been turned off, you must first lift the handset or press the **SPEAKER** button before you begin dialing.

## TRANSFERRING CALLS

Transfer is used to send any call to another extension in one of two ways. You can do a screened transfer by informing the other extension who is calling or you can do a blind transfer without notification.

- While on a call, press the **TRANSFER** button and dial an extension number or group number. Your call is automatically put on transfer hold. **OR** Press a **DSS** button or station group button. Your call is automatically put on transfer hold.
- Hang up when you hear ringing (this is an unscreened or blind transfer).  
**OR**  
Wait for the called party to answer and advise him/her of the call and hang up. If the transfer is refused, you will be reconnected to the outside line when the called station hangs up or you can press **TRANSFER** to return to the outside party. If you wish to send the call to another extension without waiting for the

first station to hang up, simply press another **DSS** button. **OR** Press the **CALL** button or C.O. line button to return to the outside party and begin the transfer process again.

When you are transferring a call to a keyset set for Voice Announce or Auto Answer, the transferred call will always ring.

NOTES:

1. After the inside party answers, you may alternate back and forth between the parties by pressing the **TRANSFER** button.
2. If you receive No More Calls tone, that station has no button available to receive another call. Press **TRANSFER** to return to the other party.
3. You cannot transfer an Intercom call by pressing a DSS button. You must press the **TRANSFER** button and dial the destination extension number.

## TRANSFER WITH CAMP-ON

When you are transferring a call to another station and you receive a busy signal, you may camp the call on to this station. Simply hang up when you hear the busy signal. The called party will be alerted that a call is waiting for them.

NOTE: If you receive No More Calls tone, that station has no button available to receive another call. Press **TRANSFER** to return to the outside caller.

## TRANSFER TO VOICEMAIL

This feature is used to send a call directly to a voice mailbox. Your keyset must have a correctly programmed **VT** button to accomplish this. To transfer a call directly to a voice mailbox:

- While on a call, press the **VT** button and dial the mailbox number.
- Hang up when dialing is completed.

## CALL WAITING

If an outside call has been camped-on to your phone or another station has camped-on to you:

- You will hear a tone in the earpiece and the call that is waiting for you (camped-on) will flash. In addition the bottom line of the display will indicate the number of the station or trunk party camped-on.
- Press the flashing button to answer; your other call will go on hold automatically if your station has the Automatic Hold feature set. If not, you must press

**HOLD** and then the flashing button **OR**

Finish the first call and hang up; the waiting call will ring.

- Lift the handset or press the **SEND** button to answer.

NOTE: Intercom calls will not go on Automatic Hold.

## CONFERENCE CALLS

You may conference up to five parties (you and four others) in any combination of outside lines and internal stations in any order.

- While engaged in a conversation, press the **CONF** button and receive conference tone.
- Make another call, either intercom or outside, press the **CONF** button and receive conference tone.
- Make another call or press the **CONF** button to join all parties.
- Repeat the last step until all parties are added.

NOTE: When attempting to add another party to the conference and you are not able to reach the desired person, hang up. Simply press the **CONF** button again to return to your previous conversation.

### To drop a party from your conference call:

- Press **CONF** and dial the extension or line number that is to be dropped.
- Press **CONF** again to reestablish the conference.

NOTE: To leave the conference, hang up. Control is passed to the next internal station. If there are no internal stations and you wish to leave outside lines connected together in a trunk to trunk conference, press the **CONF** button plus the **CALL** button that the call appears on or follow the instructions to drop a party and use your extension number. When they hang up, the lines will release automatically. Press **CONF** to rejoin a trunk to trunk conference.

### CONFERENCE SPLITTING

If you are the controlling party of a conference and your keyset has the Auto Hold feature turned on ([See Customizing Your Keyset](#)) and all of the outside lines involved in the conference appear as buttons on your keyset, you can split the conference into separate calls as follows:

- Press any one of the outside line buttons. That outside line will remain steady green to indicate you are still connected to it. All other outside lines in the conference will be placed on system hold at your keyset. All intercom callers in the conference will be disconnected. You may now speak with each caller privately and transfer them as usual or reestablish another conference.

## FORWARDING CALLS

You may forward your calls to another station, group of stations or an external telephone number. Program a destination for the type of forwarding you want as detailed below. If you have **FWD ALL**, **FWD BUSY** and **FWD NO ANSWER** buttons, press one to turn that forward feature on. A steady red light reminds you what forward condition is activated.

You can clear all call forward conditions set at your station by lifting the handset and dialing **600**.

## FORWARD ALL CALLS

To forward all your calls under any condition to another station:

- Dial **601** plus the extension or group number.
- Receive confirmation tone and hang up.

NOTES:

1. If the Hot Keypad feature has been turned off, you must first lift the handset or press the **SPEAKER** button before you begin dialing.
2. The station that receives a Forwarded All call can transfer the call to the forwarded station. This is useful when you are expecting an important call but you do not wish to be disturbed by other calls.
3. When a station user places his/her keyset in Forward All mode and he/she does not have a **FORWARD ALL** button, the **TRANSFER** button will light to indicate Forward All has been set and calls to this station have been transferred elsewhere.

## FORWARD BUSY

To forward calls to another station when you are on the phone:

- Dial **602** plus the extension or group number.
- Receive confirmation tone and hang up.

NOTE: If the Hot Keypad feature has been turned off, you must first lift the handset or press **SPEAKER** before you begin dialing.

## FORWARD NO ANSWER

To forward calls to another station when you do not answer:

- Dial **603** plus the extension or group number.
- Receive confirmation tone and hang up.

NOTE: If the Hot Keypad feature has been turned off, you must first lift the handset or press the **SPEAKER** button before you begin dialing.

## FORWARD BUSY/NO ANSWER

If you have both a Forward on Busy destination and a Forward No Answer destination programmed, you may set both of these at the same time:

- Dial **604**.
- Receive confirmation tone and hang up.

NOTE: If the Hot Keypad feature has been turned off, you must first lift the handset or press the **SPEAKER** button before you begin dialing.

## FORWARD FOLLOW ME

When you want all calls to your extension forwarded to the extension where you are now:

- Dial **606** plus your extension number.
- Receive confirmation tone and hang up.

If you want a specific extension's calls forwarded to your phone (Remote Call Forward):

- Dial **606** plus the desired extension number.
- Receive confirmation tone and hang up.

NOTE: If the Hot Keypad feature has been turned off, you must first lift the handset or press the **SPEAKER** button before you begin dialing.

## FORWARD DND

To forward your phone when you activate DND.

- Dial **605** plus the extension number or group number.
- Receive confirmation tone and hang up.

NOTE: If the Hot Keypad feature has been turned off you must first lift the handset or press the **SPEAKER** button before you begin dialing.

## CALL FORWARD OPTIONS

A display keyset may review or change call forward options and destinations. Call forward access can be done via the keypad or by accessing the keyset display features. To review or change call forward options:

- Press **TRANSFER 102**.  
The display will indicate the current call forward condition and destination  
**OR**  
Show **0:FORWARD CANCEL** to indicate no forward is set.

- Dial **0** to cancel current condition **OR**  
Dial **1-5** to select the forward type **OR**  
Press **UP** or **DOWN** to select the forward type.  
Press the right soft key to move the cursor.
- Dial the destination number (e.g., **202**) **OR**  
Press **UP** or **DOWN** to select the destination  
Press the right soft key to move the cursor
- Dial **1** to set **OR**  
Press **UP** or **DOWN** to select **YES** or **NO**
- Press **TRANSFER** to store and exit

## STATION CALL PICKUP

To pick up (answer) a call ringing at another station, lift the handset and dial **66** plus the extension number of the ringing phone.

If you have a **DP** key assigned with a station number, you only need to press this **DP** key with the flashing light to answer this ringing station.

NOTE: If the Hot Keypad feature has been turned off, you must first lift the handset or press the **SPEAKER** button before you begin dialing.

## GROUP CALL PICKUP

To pick up (answer) a call ringing in any pickup group, lift the handset and dial **66** plus the desired **group number** or press the flashing **GROUP PICKUP** button if available.

### GROUP NUMBERS

<b>01-10</b>	<b>OfficeServ 7030</b>
<b>01-20</b>	<b>OfficeServ 100, OfficeServ 7100 and OfficeServ 7200-S</b>
<b>01-99</b>	<b>OfficeServ 500 M</b>
<b>01-99</b>	<b>OfficeServ 500 L</b>
<b>01-99</b>	<b>OfficeServ 7200 and OfficeServ 7400</b>

NOTES:

1. A group pickup button can have an extender for a specific pickup group.
2. If the Hot Keypad feature has been turned off, you must first lift the handset or press the **SPEAKER** button before dialing the access code.

## MY GROUP PICKUP

If desired, a new access code can be assigned to pickup ringing calls in the same pickup group as you are in. Like "66" above except you do not need to dial the desired group number. See your installation company for the assigned access code. MY GROUP PICKUP: \_\_\_\_\_.

## PRIVACY RELEASE

This feature will allow another station to join in our conversation by releasing privacy on the C.O. from your phone.

### To Release Privacy:

While you are talking on a C.O. line and you wish to have other internal parties (or up to three) join the conversation.

- Press the **PRB** button (the **PRB** button will light steady red). Inform the other party that he/she may now join the conversation.

After the other party (or parties) has joined the conversation and you wish to return privacy to the line so that no one else can join the conversation, press the **PRB** button a second time, the **PRB** button will be off.

### To Join a Non-Private Conversation:

When someone has informed you that you can join a conversation:

- Press the **C.O. line** button that he/she has indicated.  
OR
- Dial the **C.O. line number** that he/she has indicated.

## DIALING FEATURES

All "DIALING FEATURES" instructions are written to support Overlap Dialing mode. This is the technical name for dialing from a telephone as it has been for many years. In recent years the cell phone industry has changed the cell phones to use Enblock Dialing. With this dialing mode all the digits are dialed and then sent to the carrier after pressing the SEND key. Please check your telephone setup to confirm what dialing mode is used.

## SPEED DIALING

You can dial a preprogrammed telephone number stored in the system-wide speed dial list of numbers 500~999 or from your personal list of numbers 00~49.

Your system may be set for 950 system wide numbers. If so the system speed dial access codes are 050~999 and the station speed dial codes are 000~049.

- With the handset on-hook, press the **MEMORY** button or dial **16**.
- Dial the desired speed dial number.
- The telephone number is automatically dialed for you.

NOTE: If the Hot Keypad feature has been turned off, you must first lift the handset or press the **SPEAKER** button before you begin dialing.

## PROGRAMMING PERSONAL SPEED DIAL NUMBERS

You can program frequently dialed telephone numbers in a personal speed dial list. A station may be assigned up to fifty numbers, **00-49**. See your system administrator to determine the amount assigned to your station.

- While on-hook, press **TRANSFER** and then dial **105**.
- Dial a speed dial number (**00-49**).
- Dial a line or line group access code.
- Dial the telephone number to be stored (24 digits maximum). It can include #, \*, FLASH and PAUSE.
- Press **TRANSFER** to store the number.

NOTE: If the Hot Keypad feature has been turned off, you must first lift the handset or press the **SPEAKER** button before you begin dialing.



For the purposes of programming speed dial numbers, the programmable buttons are known as **A**, **B**, **C**, **D**, **E** and **F**.

- The **A** button is not used.
- The **B** button inserts a flash.
- The **C** button inserts a pause.
- The **D** button is used for pulse to tone conversion. If your system uses rotary (or pulse) dialing C.O. lines, pressing **D** while entering a speed dial number causes all subsequent digits to be sent as DTMF tones.
- The **E** button is used to hide digits. Display keyset users may want to hide some speed dial numbers so that they will not show in the display. When you are entering a telephone number, press **E**. All subsequent digits will be hidden. Press **E** again to begin displaying digits.
- The **F** button is used to enter a name. [See \*Personal Speed Dial Names under Display Features.\*](#)
- Use the **HOLD** button to clear a speed dial number.

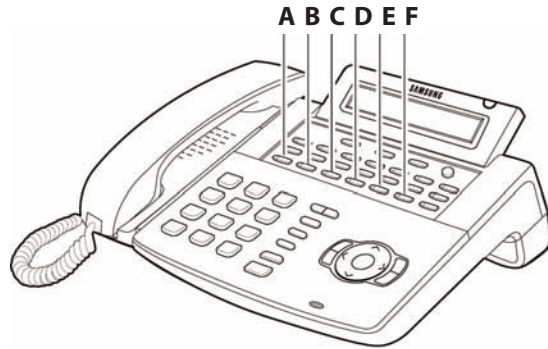

## ONE TOUCH SPEED DIALING

You may assign any speed dial number to an already existing One Touch Speed Dial button for quick and easy dialing of frequently used numbers.

- While on-hook, press **TRANSFER** and then dial **107**.
- Press a One Touch Speed Dial button.
- Dial the speed dial number (**00-49** or **500-999**) that you want assigned to this button.
- Press **TRANSFER** to store your selection.

To call this telephone number, just press the One Touch Speed Dial button.

NOTE: If the Hot Keypad feature has been turned off, you must first lift the handset or press the **SPEAKER** button before you begin dialing.

## LAST NUMBER REDIAL

To redial the last telephone number you dialed, press the **REDIAL** button or dial **19**.

NOTES:

1. If the Hot Keypad feature has been turned off, you must first lift the handset or press the **SPEAKER** button before you begin dialing.
2. Redial does not apply to intercom calls.

## MANUAL RETRY WITH REDIAL

While you are on an outside call listening to a busy signal and you want to redial the same number dialed.

- Press the **REDIAL** button.

This will hang up your existing call and manually redial the same number dialed. You can repeat this operation for a limited number of attempts.

NOTE: If your keyset is programmed with Call Log Blocks then the Redial will access the call log when pressed.

## SAVE NUMBER WITH REDIAL

To save the number you just dialed for later use, press the **SNR** button before hanging up.

To redial this saved number at any time, press the **SNR** button or dial **17**. The same line will be selected for you.

NOTES:

1. If the Hot Keypad feature has been turned off, you must first lift the handset or press the **SPEAKER** button before you begin dialing.
2. The saved telephone number is stored in memory until you save another number.
3. Redial does not apply to intercom calls.

## CHAIN DIALING

You may manually dial additional digits following a speed dial number or chain as many speed dial numbers together as required:

- After the first speed number is dialed, press **MEMORY** again and dial another speed number **OR** manually dial additional digits following a speed dial number.

## AUTOMATIC REDIAL/RETRY

When you are making an outside call and you receive a busy signal, the system can automatically redial the number for you. It will automatically redial at a pre-programmed interval for up to 15 attempts.

- When you hear a busy signal, press the **RETRY** button.
- The system will reserve the line and automatically redial the same number for you. You will hear the call being made through the keyset speaker. The microphone is muted.

- When the called party answers, lift the handset or press the flashing **SPEAKER** to begin speaking.

NOTES:

1. If you make another call, auto-redial is canceled.
2. To cancel a retry, lift and replace the handset.

## PULSE TO TONE CHANGEOVER

When making an outside call on a dial pulse line, press #. All digits dialed after the # will be sent as tones.

## MEMO REDIALING

When you are calling directory information, you can store the number you are given using the **SAVE** feature. There is no need for pencil and paper.

- While you are talking on an outside call, press **SAVE**.
- Dial the telephone number as it is dictated to you on the keypad.
- Press **SAVE** to store the number.

To dial the number, press the **SNR** button. It will select the same line and dial the stored number. If necessary, you can select a different line and then press the **SNR** button.

# PAGING AND MESSAGING

## MAKING AN INTERNAL PAGE

To make an announcement through the keyset speakers in the idle condition:

- Lift the handset.
- Press the **PAGE** button or dial **55**.
- Dial the desired zone number **0, 1, 2, 3** or **4**.
- After the attention tone, make your announcement.

NOTES:

1. If you have a dedicated page zone button, it is not necessary to press **PAGE** and dial a zone number.
2. If allowed by your system administrator you may be able to initiate a page from a speakerphone by pressing the **PAGE** key or dialing **55** without lifting the handset.

## MAKING AN EXTERNAL PAGE

To make an announcement through the external paging speakers:

- Lift the handset.
- Press the **PAGE** button or dial **55**.
- Dial the desired zone number **5, 6, 7** or **8 OR**  
Dial **9** to page all external zones.
- After the attention tone, make your announcement.

NOTES:

1. If you have a dedicated page zone button, it is not necessary to press **PAGE** and dial a zone number.
2. If allowed by your system administrator you may be able to initiate a page from a speakerphone by pressing the **PAGE** key or dialing **55** without lifting the handset.

## ALL PAGE

To page all designated keysets in internal zone 0 and all external zones at the same time:

- Lift the handset.
- Press the **PAGE** button or dial **55**.
- Dial **\*** or press the **ALL PAGE** button.
- After the attention tone, make your announcement.

#### NOTES:

1. The LED on the **PAGE** button will only light when an All Page is in progress.
2. If allowed by your system administrator you may be able to initiate a page from a speakerphone by pressing the **PAGE** key or dialing **55** without lifting the handset.

## MEET ME PAGE

- Lift the handset.
- Press the Meet Me Page (**MMPG**) button or dial **54**.
- Dial the desired zone number.
- After the attention tone, instruct the paged person to dial **56**.
- Press **WAIT** or **TRANSFER**.
- Remain off-hook until the person dials **56** from any phone.
- The paged person will be automatically connected with you.

## CALL PARK AND PAGE

When you have an outside call for someone who is not at his/her desk, you can park the call prior to paging. There are two different methods:

#### MANUAL PARK ORBITS

- While in conversation, press the **PARK** button.
- Entered a desired orbit number (**0-9**), if the orbit number is busy dial another orbit number. Display users can press **\*** to automatically place the call in any available orbit number and see the number in the display.
- Remember the selected orbit number.
- Replace the handset when finished.
- Lift the handset and make a page announcement as previously described (example: "John Smith park two").

#### To retrieve a parked call from orbit:

- Press the **PARK** button and dial the announced orbit number (**0-9**).
- You will be connected to the parked call.

#### NOTES:

1. You must have a **PARK** button or park access code to retrieve and place calls in park orbits.
2. If the parked call is not retrieved within a pre-programmed period of time, it will recall your keyset and have a slow flashing amber light. You cannot park and page intercom calls.
3. If the Hot Keypad feature has been turned off, you must first lift the handset or press the **SPEAKER** button before you begin dialing.

#### AUTOMATIC PARK WITH PAGE BUTTON

- While in conversation, press the **PAGE** button. The call is automatically parked at your station.
- Receive page tone and dial a desired page zone number.
- Make announcement indicating your extension number or the line number. Hang up.

#### To retrieve an automatically parked call:

- Dial **10** plus the number that was announced. If you have a **PAGPK** button, press it and dial the number that was announced. If you have a **PARK** button, press it and dial the announced orbit number.
- You will be connected to the parked call.

#### NOTES:

1. If the call is not retrieved within a pre-programmed period of time, it will recall your keyset and have a slow flashing amber light. You cannot park and page intercom calls.
2. If the Hot Keypad feature has been turned off, you must first lift the handset or press the **SPEAKER** button before you begin dialing.

## SETTING A MESSAGE INDICATION

When you are calling another station and no one answers or you receive a busy signal, you can leave a message indication:

- Press the **MESSAGE** button or dial **43** and receive confirmation tone.
- Hang up. The **MESSAGE** button on the called station will light. Standard telephones receive special dial tone as a message indication or a lit message lamp, if the phone is equipped with one and they are connected to an 8MWSLI card (not available on the OfficeServ 100 or OfficeServ 7000 Series) or a 16MWSLI card on the system.

#### NOTES:

1. A station can have up to five message indications.
2. If the Hot Keypad feature has been turned off, you must first lift the handset or press the **SPEAKER** button before you begin dialing.

## CANCELING MESSAGES

To cancel a message indication that you left at another station, dial **42** plus the extension number of the station at which you left a message. To cancel all message indications left at your keyset, dial **42** plus your extension. Your **MESSAGE** light will go out.

NOTE: If the Hot Keypad feature has been turned off, you must first lift the handset or press the **SPEAKER** button before you begin dialing.

## RETURNING MESSAGES

- Press the **MESSAGE** button or dial **43**. The first station that left a message will be called automatically. If that station does not answer, your **MESSAGE** light will stay on.
- Repeat until all messages have been returned in the order received.
- Your **MESSAGE** light will turn off when all messages have been returned.

### NOTES:

1. Display keyset users can view message indications and return them in any order. [See Viewing Message Indications under Display Features.](#)
2. If the Hot Keypad feature has been turned off, you must first lift the handset or press the **SPEAKER** button before you begin dialing.
3. If a message has been left at your keyset by a keyset in Auto Answer, you must manually cancel the message after it has been returned.

## PROGRAMMED MESSAGES

When you will be away from your phone for any length of time, you can leave a programmed station message. Display stations calling you will see this message and be informed of your status or follow your instructions.

- Dial **48** plus any of the message codes (**01–20**) listed on the back of this user guide.
- To cancel any of these messages you might have selected, dial **48** plus **00**.
- Press **TRANSFER** to exit and store your selection.

NOTE: If the Hot Keypad feature has been turned off, you must first lift the handset or press the **SPEAKER** button.

You can have multiple programmed message buttons (**PMSG**) and each one can have a different message code:

- Press any programmed message (**PMSG**) button. The message is set and the button will light red. Press the button again to turn off.
- Pressing another programmed message (**PMSG**) button will turn the previous one off and set a different programmed message.

## CONVENIENCE FEATURES

### LOGGING IN AND OUT

If enabled, your ITP-5121D telephone may require you to log in before making or receiving calls. In these cases your telephone system administrator will provide you with an extension number, password, and the feature code used to log out.

#### To log in:

- Press **ENTER** to begin login.
- Dial your extension number.
- Press **ENTER**.
- Dial your password.
- Press **ENTER** twice.

#### To log out:

- Dial the feature code provided by your administrator (for example 77).

### DO NOT DISTURB

Use this feature when you want to block calls to your keyset.

- While on-hook, press the **DND** button or dial **401**. The **DND** button lights steady red to remind you of this mode.
- To cancel DND, press the **DND** button again or dial **400**. The **DND** light turns off. You can make calls while in the DND mode.

### NOTES:

1. If the Hot Keypad feature has been turned off, you must first lift the handset or press the **SPEAKER** button.
2. If you place your keyset in DND mode and you do not have a **DND** button, your **TSI** button will flash to indicate DND status.

### ONE TIME DND

If you are on a call and you do not wish to be interrupted while on that call, you can press the **DND** button and place your station in Do Not Disturb. When you hang up at the end of the call, DND will be automatically canceled and your keyset will be able to receive new calls. This feature requires a **DND** button.

## MUTE

You can mute the handset transmitter or the microphone during any conversation:

- Press the **MUTE** button. It will light red.
- To resume speaking, press the **MUTE** button again. The light turns off.

## BACKGROUND MUSIC

When a music source is supplied, you may listen to music through the speaker in your keyset:

- While on-hook, press the **HOLD** button to hear music.
- Press the **HOLD** button again to turn music off.

You can set the level of background music by using the **VOLUME** buttons while listening to the music. This does not affect the speakerphone level.

## ESTABLISHED CALL PICKUP

To pick up an established call in progress at a single line extension connected to a computer modem on your PC.

- Press the **EP** button for that station on your keyset and the call is automatically moved to your keyset.
- The single line extension on your modem will be disconnected.

NOTE: You must have an assigned (EP button) button on your regular keyset, for the single line station.

## APPOINTMENT REMINDER/ALARM CLOCK

This feature works like an alarm clock. Use it to remind yourself of an appointment later in the day (TODAY ONLY) or as a daily reminder every day (DAILY). You can set up to three alarms. Each one can be either a TODAY ONLY or a DAILY alarm.

When the alarm rings, you will hear three short rings repeated three times. Lift the handset to answer the alarm. If you do not, the alarm will alert you two more times at five minute intervals.

To set alarms:

- Press **TRANSFER** and then dial **112**.
- Dial the alarm number **1, 2** or **3**.
- Dial the time at which you want the alarm to sound. Enter the time as HHMM (hours and minutes) using the 24 hour clock.
- Dial **0** (NOT SET), **1** (TODAY ONLY) or **2** (DAILY) to select the alarm type.

- Press **TRANSFER** to save.
- Repeat for each alarm if needed.

To cancel individual alarms:

- Press **TRANSFER** and then dial **112**.
- Dial alarm number **1, 2** or **3**.
- Press the **HOLD** button.

NOTE: Display keysets can show a reminder message. [See Alarm Reminder Messages under Display Features.](#)

## ANSWERING THE DOOR PHONE

When you are programmed to receive calls from a door phone:

- You will receive three short rings repeated.
- Lift the handset or press **SEND** button. You are connected to the door phone.
- If an electric door lock release is installed, dial **13** to unlock the door.

## CALLING THE DOOR PHONE/ ROOM MONITOR

You may call the door phone and listen to what may be happening outside or in another room.

- Dial the extension number of the door phone.
- You will be connected to the door phone and you can listen or have a conversation.
- If an electric door lock release is installed, dial **13** to unlock the door.

NOTE: If the Hot Keypad feature has been turned off, you must first lift the handset or press the **SPEAKER** button.

## EXECUTIVE/SECRETARY HOT LINE

If programmed, an executive and a secretary can have a hot line between them. When the executive station is in the DND mode, all of its calls will ring the secretary station. If the secretary does not answer, the caller will go to the secretary's voice mail box if setup.

- Either person can press the **BOSS** button to make a voice call to the other station.
- Using the hot line will override DND at the other station. This button will light red when the other station is in use.

### To transfer a call to a Boss in DND:

- Press the **TRANSFER** button followed by the **BOSS** button.
- Wait for the **BOSS** to answer, then announce the call and hang up to complete the transfer **OR**
- Hang up to complete a blind transfer after pressing the **BOSS** button.

## EXECUTIVE DIVERT

When the executive station is in the DIVERT mode all of his/her calls will ring the secretary station.

- Press the **DIVERT** button to pass a call while ringing.

### To transfer all calls to the Secretary:

- Press the **DIVERT** button while the phone is idle. The LED will be lit and all calls will ring the secretary.

The secretary can call the BOSS in the DIVERT mode but all other users will ring the secretary (the secretary can override the boss' DIVERT).

## GROUP LISTENING

When you are engaged on a call and you are using the handset, you may want other people to hear the distant party's voice over the speaker:

- Press the **LISTEN** button to turn on the speaker. The microphone is not in use, so the distant party does not hear other parties present in your office.
- Press **LISTEN** again to turn the speaker off and resume private conversation.
- Repeat if necessary.

NOTE: Depending on speaker volume and the acoustics of your office, it may be advisable to turn the group listening feature off before hanging up. This will eliminate a momentary squeal.

## ACCOUNT CODES

When enabled, your system allows calls to be charged to different accounts. You can enter account codes either by dialing the full code, by entering an account code "bin number", or by pressing your **ACC** key if one is assigned. Bin numbers are a 3 digit short code that will automatically insert the appropriate account code. Account codes may be a maximum of 12 digits (# may be used); if the account code is to be less than 12 characters you may end the code by pressing \* or the right soft key. The type of code used is determined by your telephone system administrator. Codes can be entered before or during a call as follows:

To enter an account code before placing the call:

- Press your **ACC** key or dial **47**.
- Dial the account code or bin number.
- You will receive a confirmation tone and display.
- When prompted dial a trunk or trunk group (i.e. 9) and the telephone number to call.

To enter an account code by interrupting the conversation:

- While on an outside call press the **ACC** key or press **TRANSFER** followed by **47**.
- Dial the account number or bin number (if you are entering an account code you will need to press your **ACC** key or right soft key to finalize the entry)

NOTE: If you make an error simply repeat the procedure with the correct code. Only the most recent account code dialed will be recorded.

## LOCKING YOUR KEYSSET

You can lock your keyset to control misuse of your phone while you are away. You can unlock it when you return. Your default station passcode is 1234.

	0 UNLOCKED	1 LOCKED OUTGOING Hold Button LED Flashes	2 LOCKED ALL CALLS Hold Button LED Solid
Make outside calls	YES	NO ACCESS DENIED	NO
Receive outside calls	YES	YES	NO
Make intercom calls	YES	YES	NO
Receive intercom calls	YES	YES	NO
Make 911 calls	YES	YES*	NO

- While on-hook, press **TRANSFER** and then dial **100**.
- Dial your four digit station passcode.
- Dial **1** to locking outgoing, **2** for locked all calls, or **0** to unlock.
- Press **TRANSFER** to store your selection.

Note\*: When 911 is programmed, 911 emergency dialing is allowed for a LOCKED OUTGOING station.

## MANUAL SIGNALLING

Use this feature when you want to send a brief 500ms ring burst to another station, regardless of the status of your phone (on-hook, off-hook, handsfree, DND, or ringing).

### To send a signal to another station:

- Press the Manual Signalling (**MS**) button.
- You may press the **MS** button repeatedly to send multiple signals to the designated station.

**NOTE: Your phone must have a Manual Signalling (MS) button with a station number extender assigned to it.**

## OFF-HOOK VOICE ANNOUNCE

Keysets may receive a voice announcement while on another call. The calling station must have an **OHVA** button. When you are in DND, you cannot receive OHVA calls. The OHVA feature will work with intercom and transferred calls.

When you receive an OHVA and secure OHVA is ON, you will hear the announcement in the handset receiver, if you are using the handset. If secure OHVA is OFF then you will hear the announcement on the speaker, if you are talking on the handset. If you are using the speakerphone the announcement will always be heard through the speaker.

### To make an off-hook voice announcement:

- Dial the extension number or press the **DSS** button.
- When you receive a busy signal, press the **OHVA** button.
- After the attention tone, begin speaking.
- Finish the call by replacing the handset.
- Press the flashing **CALL** button on your keyset. This will place the original party on hold and allow you to talk to the announcing party.
- To return to your first party, press the button corresponding to your original call. This will disconnect the OHVA call.

### NOTES:

1. When you are voice announcing to a station close to you, use the handset to avoid an echo effect.
2. You cannot off-hook voice announce to single line telephones.

## OHVA BLOCK

Your keyset can be programmed with an OHVA Block (**BLOCK**) button. Pressing this button will prevent anyone from making an OHVA to you until you press the button again and cancel the blocking.

## OHVA REJECT

Your keyset can be programmed with an OHVA Reject (**REJECT**) button. Pressing this button while receiving an OHVA call will disconnect the voice announcing party and return you to your original call.

## IN GROUP/OUT OF GROUP

If your keyset is assigned to a station ring group, you can remove your keyset from the group and then put it back in. While you are out of the group, you can receive calls to your extension number but not calls to the group number. If you have an **IN/OUT** button with the group number assigned.

- Press the **IN/OUT** button. It will light red when your keyset is in the group.
- Press the **IN/OUT** button again to exit the group and turn the light off. Repeat as necessary.

If you do not have an **IN/OUT** button:

- Dial the **IN/OUT** access code number \_\_\_\_\_, then the group number, then **0** to exit the group or **1** to enter the group.

**NOTE:** If the Hot Keypad feature has been turned off, you must first lift the handset or press **SPEAKER** button.

The **IN/OUT** button can include an extender to indicate the specific group that this button will affect. This means that if you are in multiple groups, you can decide for which groups you will receive calls.

# CUSTOMIZING YOUR KEYSSET

## AME PASSWORD

This feature allows customers using the AME feature to enable password protection. This will prevent unauthorized users from listening to your messages being left. The passcode is the same as your station passcode. This feature only applies if there is a Samsung Voicemail card installed in the system and your keyset has a programmed AME button.

- With the handset on-hook, press **TRANSFER** and then dial **110**.
- Dial **101** to turn on AME PASSCODE or **100** to turn it off.
- Press **TRANSFER** to store your selection.

## AUTO CAMP-ON

This option allows intercom calls to be automatically camped on, if possible, when a busy station is called.

- With the handset on-hook, press **TRANSFER** and then dial **110**.
- Press **081** to turn CAMP-ON on or **080** to turn it off.
- Press **TRANSFER** to store your selection.

## SELECT RING TONE

Each keyset user can select any one of eight ring frequencies:

- While on-hook, press **TRANSFER** and then dial **111**.
- Dial **1-8** or press the **UP** and **DOWN** buttons to hear each tone.
- When you hear the tone that you prefer, press **TRANSFER** to save it.

**NOTE: Specific lines or stations may be programmed to ring with a different tone than what you have selected for your keyset.**

## CHANGE YOUR PASSCODE

From the factory, your station passcode is 1234. You can change your station passcode whenever you desire.

- While on-hook, press **TRANSFER** and then dial **101**.
- Dial your old passcode.
- Dial a new passcode (must be four characters). You can use **0-9**.
- Redial the new passcode to verify. If successful, you will hear two beeps. Four beeps indicate an incorrect code. Reenter the code again.
- Press **TRANSFER** to store the new passcode.

## SET ANSWER MODE (INTERCOM)

You can receive internal calls in one of three modes ([see Answering Intercom Calls under Intercom Calls for descriptions](#)):

- While on-hook, press **TRANSFER** and then dial **103**.
- Dial **0** for Ringing, **1** for Auto Answer or **2** for Voice Announce.
- Press **TRANSFER** to store your selection.

**NOTE:** When your keyset is programmed for Auto Answer and you have Forward No Answer (FNA) turned on, you must answer screened transfers by pressing the **SEND** button before your FNA timer expires or the call will forward.

## SET ANSWER MODE (CO)

Your incoming CO calls can be set to follow the intercom answer mode.

- While on-hook, press **TRANSFER** and then dial **110**.
- Dial **15** to access **AUTO ANS CO**.
- Press the **VOLUME UP** or **DOWN** key to change status.
- Press **TRANSFER** to store your selection.

## AUTOMATIC HOLD

While on an outside call, pressing a line button, route button or a flashing **CALL** button will automatically put your call on hold and connect you to the next call. This feature can be turned on or off at your keyset.

- With the handset on-hook, press **TRANSFER** and then dial **110**.
- Dial **001** to turn Automatic Hold on or **000** to turn it off.
- Press **TRANSFER** to store your selection.

**NOTE:** Intercom calls can be automatically put on hold by pressing **TRANSFER**.

## HEADSET OPERATION

Keyset users can switch between headset mode and handset mode. When using headset mode, press the **SEND/END** button to answer and release calls.

- With the handset on-hook, press **TRANSFER** and then dial **110**.
- Dial **021** to use the headset or **020** to use the handset.
- Press **TRANSFER** to store your selection.



Your keyset may be equipped with a Headset mode button. If it is so equipped pressing this button while the light is out will cause the keyset to enter headset mode and the light will illuminate to indicate this. Pressing the button while the light is lit will cause the keyset to return to handset mode and the light will go out.

## HOT KEYPAD

On your phone system your keyset's keypad can be made "live" or "hot" so that it is not necessary to lift the handset or press the **SPEAKER** button before you begin dialing. Calls can be made and features activated by simply dialing the C.O. line number, trunk group access code, intercom number or feature access code. To activate this feature:

- With the handset on-hook, press **TRANSFER** and then dial **110**.
- Dial **031** to turn the Hot Keypad on or **030** to turn it off.
- Press **TRANSFER** to store your selection.

## KEY CONFIRMATION TONE

You can hear a short beep (confirmation tone) each time you press a button on the dial pad. This tone can be turned on or off.

- While on-hook, press **TRANSFER** and then dial **110**.
- Dial **040** to turn tones off or **041** to turn tones on.
- Press **TRANSFER** to store your selection.

## REJOINING A PAGE

This feature allows you to hear the remaining portion of an ongoing internal page after you return your keyset to idle. To enable this feature:

- With the handset on-hook, press **TRANSFER** and then dial **110**.
- Dial **051** to turn this feature on or **050** to turn it off.
- Press **TRANSFER** to store your selection.

## RING PREFERENCE

This feature automatically answers ringing calls when you lift the handset or press the **SEND** button. This method will always answer calls in the order they arrived at your keyset. When you turn ring preference off, you must press the flashing button to answer a call, allowing you to answer calls in the order you choose.

- With the handset on-hook, press **TRANSFER** and then dial **110**.
- Dial **061** to turn ring preference on or **060** to turn it off.
- Press **TRANSFER** to store your selection.

## AUTO ANSWER CO CALLS

This option will allow CO calls that directly ring your phone to auto answer. When a CO call arrives at your station and this option set for ON your phone will sound two beeps, the same as when a screened transfer is completed, and you will be connected to the CO call. In order for this option to work the station must also be programmed for auto answer ([see SET ANSWER MODE](#)).

- While on hook, press **TRANSFER** and then dial **110**.
- Dial **151** to turn Auto Answer CO on or **150** to turn it off.
- Press **TRANSFER** to store your selection.

NOTE: Outside lines must ring your station directly for the Auto Answer CO to work. Lines ringing a station group will not cause your phone to Auto Answer.

## DISPLAY SPEED DIAL NAME

This option allows you to view the name associated with a speed dial number as it is dialed.

- With you handset on-hook, press **TRANSFER** and then dial **110**.
- Press **111** to turn **DISP SPDNAME** on or **110** to turn it off.
- Press **TRANSFER** to store your selection.

## CALLER ID REVIEW ALL

This feature allows display keyset users to review Caller ID information for calls sent to their stations. This list can be from ten to fifty calls in a first in, first out basis. The list includes calls that you answered and calls that rang your station but that you did not answer. When reviewing this list, you can press one button to dial the person back. The system must be using LCR to dial the stored number.

- With you handset on-hook, press **TRANSFER** and then dial **110**.
- Press **121** to turn **CID REVIEW ALL** on or **120** to turn it off.
- Press **TRANSFER** to store your selection.

## SECURE OHVA

This option allows you to receive OHVA calls via the speaker while you are on the handset.

- With you handset on-hook, press **TRANSFER** and then dial **110**.
- Press **131** to turn **AUTO CAMP-ON** on or **130** to turn it off.
- Press **TRANSFER** to store your selection.

## ENBLOCK DIALING

This option allows you to dial digits then press the **SEND** button to make the call (like a cellphone).

- While the handset on-hook press **TRANSFER** then dial 110.
- Dial **161** to turn Enblock Dialing ON or **160** to turn it off.
- Press **TRANSFER** to store your selection.

## CONFIGURE MOBILE EXTENSIONS (MOBEX)

This feature allows you to configure options for any Mobile Extension (MOBEX) ports that are assigned to you by your telephone system administrator. You can turn a port on or off; set the telephone number for the port; or set the caller ID you will be calling in from. The caller ID field has no effect unless you have been authorized as an Executive MOBEX user. Check with your telephone system administrator for further details on your specific system configuration.

### To set the phone number a MOBEX port can reach you on:

- Press **TRANSFER** and then dial **126**.
- Dial your station pass code.
- Dial the number of the port you wish to configure (1-5) (you may also use the Volume Up and Volume Down keys to select a port and press the right soft key to confirm).
- Dial **0** to select the telephone option.
- Dial the number of a C.O. line to use when making calls to this MOBEX port.
- Dial the phone number you can be reached at by users calling this MOBEX port.
- Press **TRANSFER** to store your selection and exit programming.

### To set the caller ID of the location you will be calling in from:

- Press **TRANSFER** and then dial **126**.
- Dial your station pass code.
- Dial the number of the port you wish to configure (1-5) (you may also use the Volume Up and Volume Down keys to select a port and press the right soft key to confirm).
- Dial **1** to select the caller ID option.
- Dial the phone number you will be calling in from.
- Press **TRANSFER** to store your selection and exit programming.

### To turn a MOBEX port ON or OFF:

- Press **TRANSFER** and then dial **126**.
- Dial your station pass code.
- Dial the number of the port you wish to configure (1-5) (you may also use the Volume Up and Volume Down keys to select a port and press the right soft key to confirm).
- Dial **2** to select the activation status option.
- Dial **0** to turn the port on, dial **1** to turn the port off.
- Press **TRANSFER** to store your selection and exit programming. To turn a MOBEX port ON or OFF:
- Press **TRANSFER** and then dial **126**.
- Dial your station pass code.
- Dial the number of the port you wish to configure (1-5) (you may also use the Volume Up and Volume Down keys to select a port and press the right soft key to confirm).
- Dial **2** to select the activation status option.
- Dial **0** to turn the port on, dial **1** to turn the port off.
- Press **TRANSFER** to store your selection and exit programming.

# DISPLAY FEATURES

## INTERACTIVE DISPLAY KEYS

The three keys below the display are substitutes for dedicated feature keys and access codes. Pressing one of these buttons has the same effect as pressing a programmable button. These buttons are called soft keys as their functions are not fixed. They change to present you with the best options for that call condition. The use of soft keys allows the programmable buttons to be used for more **DSS** and speed dial buttons.

The **SCROLL** button is used to display options available to the user at a particular time or during a specific procedure. Press this button once while in the idle state to view the three main categories available.

201: STN NAME  
CALL OTHER ANS

**ANSWER:** Guides you through the options to answer calls.

**OTHER:** Guides you through features other than making or answering calls.

**CALL:** Guides you through the options to make a call.

Select one of the main categories: **CALL**, **OTHER** or **ANS (ANSWER)**. Press the **SCROLL** button to display additional options available under each of the three main categories. The symbol ➡ displayed as the last character on the lower line of the display indicates that there are additional options. Press the **SCROLL** button to display these additional options.

User instructions will be displayed in lower case letters. Options assigned to soft keys will be in upper case letters.

## DIRECTORY INFORMATION

An 11 character directory name can be assigned to each extension number. Display keypad users can view the name of the called or calling station before answering.

Each outside line can have an 11 character directory name. Incoming calls can be easily identified and answered with different greetings.

Outside and internal calls ringing to a station group will display [CALL FOR xxx] where xxx is the station group number. This allows you to answer calls directed to you differently than calls directed to your group.

## CALL LOG

The system can log both incoming and outgoing calls placed from or to your telephone. You must have a **LOG** button programmed on your keyset and assigned a review list.

Each **IN** and **OUT** list can be up to 50 numbers maximum. They are assigned in blocks of 10 each.

- Press the **LOG** key.
- Press either the **IN** or **OUT** key.
- View the first IN/OUT telephone number. At this point you may select one of the three options related to this number or use the UP/DOWN keys to scroll through your list of calls.
- Press the **CLEAR** button to erase this number from the list.
- Press the NND key repeatedly to view the Name, Number, or Date associated with this call.
- Press the **DIAL** key to call this number.

These options are the same for the incoming or outgoing call logs.

## DIAL BY NAME

Each station or speed dial number can have an associated directory name. A station or speed dial number can be selected by scrolling alphabetically through a directory name list. This on-line "phone book" allows the user to look up and dial any station or speed dial number in seconds.

- Press the **DIR** button (**DIRECTORY**).
- Select the directory you wish to use: **PERS** (personal speed dial numbers), **SYS** (system speed dial numbers) or **STN** (station names).
- Dial the key on the keypad that corresponds to the first letter of the name you wish to search for.
- Use the **UP** and **DOWN** arrows to scroll through the names.
- Press the **DIAL** soft key to dial the number.

NOTE: A **DIR** button can have an extender to take you directly to one of the above lists (PERS, SYS, or STN).

## CALL PROGRESS DISPLAYS

During everyday call handling, your keyset display will provide information that is helpful and in some cases invaluable. Displays like [CALL FROM 203], [TRANSFER TO 202], [701: RINGING], [TRANSFER FM 203], [708 busy], [Camp on to 204], [Recall from 204], [Call for 501], [message frm 204] and [FWD ALL to 204] keep you informed of what is happening and where you are. In some conditions you are prompted to take an action and in other cases you receive directory information.

## DISPLAY NUMBER DIALED

Display keysets begin showing digits as they are dialed. They will stay in the display until the call duration timer comes on automatically or the **TIMER** button is pressed. If the call duration timer is not used, the number dialed will be displayed until the call is released, transferred or put on hold.

## CALL DURATION TIMER

The system can be set to automatically time outside calls. A few seconds after you dial a telephone number, the timer appears in the display. It appears immediately for incoming calls. The call timer continues for the duration of the call. Call duration times are displayed in minutes and seconds. If a call lasts longer than 60 minutes, the timer restarts.

You can press the **TIMER** button to manually begin timing a call. Press it again to stop timing. If you press it while the automatic timer is on, the call duration time is restarted.

## AUTO TIMER

Display keyset users may have the timer automatically start when they answer incoming calls or after a short delay on an outgoing call.

- With the handset on-hook, press **TRANSFER** and then dial **119**.
- Dial **41** to turn the auto timer on or **40** to turn it off.
- Press **TRANSFER** to store your selection.

## TIMER FUNCTION

Display keyset users may use this feature as a simple stopwatch.

- When the keyset is idle, press the **TIMER** button to start timing.
- Press the **TIMER** button again to stop timing.
- Read the elapsed time in the display.
- Lift the handset and replace it. The display will return to date and time.

## VIEWING MESSAGE INDICATIONS

You can view all of your message indications before you return them:

- With the handset on-hook, press the **MESSAGE** button with the red flashing light.
- The first station that left a message indication will be displayed.
- Press the **UP** and **DOWN** arrows to scroll through the stations that left message indications. Use the soft keys to reply, clear or advance to the next message.
- Press the **END** button to return your keyset to the idle condition.

## ALARM REMINDER MESSAGES

*(See also Special Application Menu-Name Search)*

When you use the alarm/appointment reminder feature, you create a 16 character reminder message. When the alarm rings, your message will appear instead of [ALARM REMINDER]. To program reminder messages:

- Press **TRANSFER** and then dial **116**.
- Dial the alarm number **1, 2** or **3**.
- Dial the time you want the alarm to go off. Enter the time as HHMM (hours and minutes) using the 24 hour clock.
- Dial **0** (NOT SET), **1** (TODAY) or **2** (DAILY) to select the alarm type.
- Write your message using the dial pad keys. Each press of a key selects a character. Pressing the next key moves the cursor to the next position. For example, if your message is "TAKE MEDICATION," press **8** once to get the letter "T." Press **2** once to get "A." Press **5** twice to get "K." Continue selecting characters from the following table to complete your message.
- Press the **TRANSFER** button to store the alarm and reminder message.
- Repeat for each alarm if needed.

COUNT	1	2	3	4	5
DIAL 0	<	>	.	)	0
DIAL 1	space	?	,	!	1
DIAL 2	A	B	C	@	2
DIAL 3	D	E	F	#	3
DIAL 4	G	H	I	\$	4
DIAL 5	J	K	L	%	5
DIAL 6	M	N	O	^	6

DIAL 7	P	Q	R	S	7
DIAL 8	T	U	V	Q	8
DIAL 9	W	X	Y	Z	9
DIAL *	:	=	[	]	*

#### NOTES:

1. When the character you want appears on the same dial pad key as the previous character, press **UP** to move the cursor one space to the right.
2. Other symbols are available for DIAL #.

To cancel an individual alarm and reminder message:

- Press **TRANSFER** and then dial **112**.
- Dial alarm number **1, 2** or **3**.
- Press the **HOLD** button.
- Press the **TRANSFER** button.

## PERSONAL SPEED DIAL NAMES

Each personal speed dial number can have an 11 character name assigned to it. This name is used to select the speed dial bin when you are dialing by directory.

- Press **TRANSFER** and then dial **106**.
- Dial the speed dial bin number **00–49**.
- Write your message using the procedure described in *Alarm Reminder Messages*.
- Press the **TRANSFER** button to store the speed dial name.
- Repeat for each speed dial bin if necessary.

## STATION NAMES

You can assign an 11 character name to your keyset. This allows other display keyset users to call you using the directory dial feature.

To program a station name:

- Press **TRANSFER** and then dial **104**.
- Enter the 11 character name using the procedure described in *Alarm Reminder Messages*.
- Press **TRANSFER** to store the name.

## MANAGING KEY ASSIGNMENTS

You can view your key assignments and add extenders to some of your programmable keys for easy one touch operation of frequently used features.

- While on-hook, press **TRANSFER** and then dial **107**.
- Use the **VOLUME** buttons to scroll through all of your programmable buttons **OR** press the programmable button to which you want to add the extender.
- When you reach a key listed below, dial the corresponding extender.
- Press **TRANSFER** to store and exit programming.

Please refer to the [Enhanced Display Programming Section](#) provided by your installation company when requested for a complete list of descriptions and extenders for any keys you may have programmed on your keyset.

NOTE: Confirm that the cursor is placed correctly before you enter the extender.

## LCR WITH CLEAR

When you are making an outside call using LCR and dial an incorrect digit, you can press the **CLEAR** soft key to reenter the telephone number. You do not need to redial **9** to reaccess LCR.

## BACKSPACE WITH LCR

If you misdial while using LCR, you can delete digits shown in the display by pressing the **BSPC** soft key as many times as necessary.

# TEXT MESSAGING

This feature allows two digital keyset users to respond to each other with pre-programmed text messages. After receiving an Off Hook Voice Announcement or Station Camp-On, you may respond with a text message while continuing to talk and listen to your outside party. The other station can view this message and take the appropriate action or respond back with another text message.

You **must** be permitted to use the Text Messaging feature. See your System Administrator or Technician to be assigned this feature. They will assign you ten (10) blank messages. You can create any 16 character messages (01 to 10) that are appropriate for your use.

NOTE: See [ALARM REMINDER MESSAGES](#) for instructions on how to enter characters to create a text message.

Familiarization with the two digit message numbers you will use the most will make this procedure quick and easy. However if you do not know them, use the **UP/DOWN** button to scroll to the desired message, then press **SEND**.

The basics steps in text messaging are:

1. Press **TMSG** soft key to begin text messaging.
2. Dial the 2 digit number for the desired message.
3. Confirm this is the intended message then press **SEND**.
4. Wait for a reply from the other station (steps 1, 2 & 3)
5. When any station presses **EXIT** the displays at both stations return to their previous call progress condition.

At all times after step 1 you can talk and listen to your caller while repeating steps 2.

The following example will better demonstrate how to use Text Messaging. In this example station 201 is making an off hook voice announcement to station 205 who after hearing the announcement will respond with a text message.

**STATION 201: LINDA**  
received a call on line 702

**STATION 205: JOHN**  
is talking on line 701

Talking on line 702

<b>702 :</b>	<b>01:15</b>	<b>701 :</b>	<b>05:25</b>
<b>CONF PAGE MUTE</b>			

Press **TRANSFER**

**Transfer:**  
**RETURN**

Dial **205**

**205:busy**  
**OHVA CAMP ON**



**OHVA to 205**

**OHVA from 201**  
**TMSG REJECT**

**Wait for reply**

**GIVE THE CALL**  
**TMSG:01 SEND**

Dial **03** or press **↑** twice

**ASK THEM TO HOLD**  
**TMSG:03 SEND**



**ASK THEM TO HOLD**  
**TMSG EXIT**

**Wait for reply**

**702 :** **01:45**  
**CONF PAGE MUTE**

**701 :** **05:55**  
**CONF PAGE MUTE**

# CALLER ID

## WHAT IS CALLER ID?

Caller ID is the name given to the telephone company-provided feature that delivers the telephone number and sometimes the name of the person calling your phone. There are two types of Caller ID; the first delivers the calling party's telephone number only and the second (sometimes referred to as "Deluxe" Caller ID) delivers both the calling party's telephone number and name as listed in the telephone directory.

The phone system can handle both types of Caller ID; in fact, in the case of number only delivery, the system can be programmed to insert a name for a specific telephone number. However, even though you are paying to receive Caller ID information, there are some circumstances that mean you will not receive this information. The six most common reasons are listed below along with the display information that the system will provide.

PRIVATE	The caller does not wish his/her name or number to be revealed to you. This type of call can be stopped at the telephone company by dialing an access code on your outside lines. This will redirect these PRIVATE calls to an announcement that states that you do not wish to receive calls that have had Caller ID blocked. The code to block these calls can usually be found in the front section of the telephone directory.
OUT OF AREA	The caller is calling from an area that cannot provide Caller ID information (for example, international calls) or he/she is calling from a type of circuit that cannot provide Caller ID information, for example, some outbound WATS lines.
PAYPHONE	The caller is calling from a coin-operated telephone. The telephone company will send this information as there are no directory listings for pay phones. The number will be delivered as usual.
INVALID CID INFO	This is a message that will be displayed when CID information is sent on the line but was somehow corrupted.
NO CID RECEIVED	This is a message that will be displayed when there was no CID information sent on the line.

### NO CID DSP

Caller ID Digital Signal Processors (CIDDSP's) are resources in the OfficeServ 100, OfficeServ 500, and OfficeServ 7000 Series systems required for receiving CID data. If there are no CIDDSP's available at the time a call comes in, this is the message you will see on your display.

NOTE: The Caller ID features may require optional software and/or hardware. Please see your service and installation company for details.

## WHAT IS ANI?

**[T1/E&M NOT SUPPORTED ON THE OS 7030, OS 7100 and OS 7200-S]**

ANI (Automatic Number Identification) is a feature offered by some telephone service providers that provides the calling party's telephone number. This service is only available on E&M Tie Lines on a T1, digital trunk. ANI is similar to Caller Identification (CID) but the format and information of the calling person is different. CID uses FSK signalling and ANI uses DTMF signalling. Usually, with ANI, a calling party's identity is the Listed Directory Number (LDN) unless a separate bill-to-number has been specified, (in which case the bill-to-number will be sent). Note that ANI does not provide calling party NAME, only the number. The phone system can provide calling number to name translation table.

## WHAT IS CLI?

On ISDN circuits, calling party information is called CLI and is supported on both BRI (BRI not supported in the US) and PRI type circuits (not supported on OS 7030). On BRI circuits the system only supports number delivery and, like ANI, a name can be attached to the telephone number of frequent callers via the Caller ID translation table. On SESS and NI2 PRI circuits both name and number support is provided on the OfficeServ 100, OfficeServ 500, and OfficeServ 7000 systems.

## SELECTING YOUR CALLER ID DISPLAY

Simultaneous display of Caller ID name and number on incoming CO calls on both lines of display keysets is supported on all OfficeServ systems. On Transferred CO calls, you can decide if you want to see the Caller ID name or Caller ID number in the display. Regardless of which data is selected, you can press the **NND** button to view the other pieces of Caller ID information. To select the type of Caller ID information you wish to view:

- With the handset on-hook, press **TRANSFER** and then dial **119**.
- To set the first line of a ringing call display dial **0**.
- To set the second line of a ringing call display dial **1**.  
Set the data to display from the following:
  - To show nothing dial **0**.

- To show Caller ID Number dial **1**.
- To show Caller ID Name dial **2**.
- To show the DID Number the call came in on dial **3**.
- To show the Name of the DID the call came in on dial **4**.
- To show the Name of the Group the call came in for dial **5**.
- To show the DID Number and then Name of the DID dial **6**.
- To show the Name of the DID and then the DID Number dial **7**.
- To set the top line of the display shown after answering a call dial **2**.  
Set the data to display from the following:
  - To show Caller ID Number dial **0**.
  - To show Caller ID Name dial **1**.
  - To show the DID Number the call came in on dial **2**.
  - To show the Name of the DID the call came in on dial **3**.
  - To show Caller ID Number and then the DID Number dial **4**.
  - To show Caller ID Name and then the DID Number dial **5**.
  - To show the DID Number and then the name of the DID dial **6**.
  - To show the Name of the DID and then the DID Number dial **7**.
  - To show the C.O. line information dial **8**.
- To set the format if the C.O. line information when the above is set to show C.O. line information dial **3**.
  - To show the C.O. line number and the dialed or Caller ID Number dial **0**.
  - To show only the dialed or Caller ID Number dial **1**.
- Press **TRANSFER** to exit and store your selection.

## VIEWING THE NEXT CALLER ID CALL

In the event that you have a call waiting or a camped-on call at your keyset, you can press the **NEXT** button to display the Caller ID information associated with the call in queue at your keyset. Either the CID name or CID number will show in the display depending on your Name/Number selection.

To view Caller ID information for calls that have been camped-on to your keyset, press the **NEXT** button. If your keyset does not have a **NEXT** button, press the **CID** button and then the **NEXT** soft key.

## SAVING THE CALLER ID NUMBER

At any time during an incoming call that provides CID information, you may press the **SAVE** button to save the CID number. If your keyset does not have a **SAVE** button, press the **CID** button, the **SCROLL** button and then the **SAVE** soft key. The system must be using LCR to dial the saved number.

## REDIALING A SAVED CALLER ID NUMBER

To redial a number that has been saved, press the **SNR** button or dial **17**.

NOTES:

1. Your telephone system must have LCR correctly programmed to redial the saved number.
2. If the Hot Keypad feature has been turned off, you must first lift the handset or press the **SPEAKER** button before you begin dialing.

## STORING A CALLER ID NUMBER

At any time during an incoming call that provides CID information, you may save the CID number as a speed dial number in your personal speed dial list. To store a Caller ID number in a personal speed dial bin:

- Press the **STORE** button. The system displays the speed dial bin in which the number was stored, **OR**
- Press the **CID** button and then press the **SCROLL** button.
- Press the **STORE** soft key.
- The system displays the speed dial bin in which the number was stored.

NOTE: Your telephone system must have LCR correctly programmed to redial the saved number. If LCR is not being used on your system, you will not be allowed to STORE CID numbers.

## INQUIRE CALLER ID PARK/HOLD INFO

If you are informed that an incoming call is on hold or has been parked for you, you may view the Caller ID information before you retrieve the call. This may influence how you choose to handle the call.

From an idle keyset:

- Press the **INQUIRE** button, **OR**  
Press the **CID** button and then the **INQUIRE** soft key.
- Dial the trunk number.
- You may now answer the call by pressing the **ANS** button, **OR**  
You may use **NND** to view more information about this call, **OR**  
You can return to the idle condition by pressing **IGNORE**.



If you are on a call:

- Press the **INQUIRE** button. Your existing call will go on hold, **OR** Press the **CID** button and then the **INQUIRE** soft key to place the first call on hold.
- Dial the trunk number.
- You may now answer the call by pressing the **ANS** button, **OR** You may use **NND** to view more information about this call, **OR** You can return to the idle condition by pressing **IGNORE**.

NOTES:

1. If you are on an intercom call or you have Automatic Hold turned off, you must finish the existing call or place it on hold before inquiring.
2. If you inquire about an outgoing call, you will receive a [call no longer available] display.

## REVIEWING PAST CALLER ID CALLS

This feature allows you to review CID information for calls sent to your keyset. This list can contain 10–50 calls in a last-in, first-out basis. The list includes calls that you answered and calls that rang your keyset but that you did not answer (missed calls). When reviewing this list, you can press one button to dial the person back. The system must be using LCR to dial the stored number. To access the CID information stored in your REVIEW list:

- Press the **REVIEW** button, **OR** Press the **CID** button and then press the **REVIEW** button.
- If you have entries in your review list, the most recent call will be shown first.
- You can now **CLEAR** this entry, **OR** Use **NND** to view more information about this call, **OR** Press **DIAL** to call this person back, **OR** Press **SCROLL** and then press **STORE** to save this number in a personal speed dial bin.

NOTES:

1. Each keyset defaults with ten review bins. Please see your system administrator to determine the number of bins assigned to your keyset.
2. Your system must have LCR correctly programmed to allow you to **DIAL** numbers from the review list or to **STORE** entries from the review list.

## SPECIAL APPLICATION MENU

Below are instructions for additional call processing and special applications that can be accomplished via the LCD programming. These features and functions can be accessed by pressing the **MENU** button. Follow the user instructions below to utilize these features and functions.

After pressing the **MENU** button, use the direction button to scroll to the desired menu option. Press **ENTER** to access the menu. To navigate within the menu you may scroll to the desired option/function or dial the associated option function number.

Press **END** button to exit programming.

## MENU OPTIONS

Note that some of the features listed here may require system programming and configuration in order to function. See your system administrator for details.

Press the **MENU** button to access the options below. Use the **UP/DOWN** directional button to scroll to, and within option menus and sub menus. You may also dial the option number, after pressing the **MENU** button.

1. **OUTGOING LOGS:** Allows you to view a list of the 30 most recent outgoing calls from the keyset. You may return the call directly from the displayed status.

- Scroll or dial option number **1. Outgoing Call Log**.
- Press **ENTER**.
- Scroll to the desired **PHONE NUMBER** and press the **SEND** button to automatically dial the number.

OR

- Press **CANCEL** to return to Main Menu.

OR

- Press **END** to exit programming.

2. **INCOMING LOGS:** Allows you to view a list of the 30 most recent incoming calls to the keyset. You may return the call directly from the displayed status.

- Scroll or dial option number **2. Incoming Call Log**.
- Scroll to the desired **PHONE NUMBER** and press the **SEND** button to automatically dial the number.

OR

- Press **CANCEL** to return to Main Menu.

OR

- Press **END** to exit programming.

**3. SPEED DIAL:** Allows you to search through Station and System Speed Dial Numbers. You may dial the number directly from the displayed status.

- Scroll or dial option number **3. Speed Dial**.
- Press **ENTER**.
- Scroll to option or dial desired option.
  1. Personal Speed
  2. System Speed
- Press **ENTER**.

OR

- Scroll to the desired number and press the **SEND** button to automatically dial the number.

OR

- Press **CANCEL** to return to main menu.

OR

- Press **END** to exit programming.

**4. DIRECTORY DIAL:** Allows you to search for station speed, system speed and station numbers based on their associated programmed name.

- Scroll or dial option number **4. Directory Dial**.
- Press **ENTER**.
- Scroll to option or dial desired option.
  1. Personal Speed
  2. System Speed
  3. Station Number
- Enter the name associated with that speed number or station number.
- Press the **SEND** button to automatically dial the number.

OR

- Press **CANCEL** to return to main menu.

OR

- Press **END** to exit programming.

**5. FORWARD SET:** Allows you to assign station call forward condition for the phone. You must first set the forward type and destination (Options 2-5) then activate the forwarding in option 1.

- Scroll or dial option number **5. Forward Set**.
- Press **ENTER**.
- Scroll to or dial the desired forward option and assign station number to forward your station to.

2. ALL FWD NO.
3. BUSY FWD NO.
4. NOANS FWD NO.
5. DND FWD NO.
0. FWD CANCEL

- Press **ENTER**.
- Scroll to or dial **1. FORWARD TYPE** and scroll to or dial the desired forward type.
- Press **ENTER** to activate the desired call forward type.
- Press **CANCEL** to return to main menu.

OR

- Press **END** to exit programming.

**6. ALARM REMINDER:** Allows you to set an Alarm Reminder. Up to three alarms may be set.

- Scroll or dial option number **6. Alarm Reminder**.
- Scroll or dial the desired Alarm number (Alarm 1-3).
- Press **ENTER**.
- Enter Alarm Type.
  0. NOT SET: Disables alarm.
  1. TODAY: Rings alarm one time only, on the day set.
  2. DAILY: Rings alarm daily at time set.
- Press **ENTER**.
- Display confirms setting and returns to that alarm set menu.
- Scroll up to set **ALARM TIME**.
- Press **ENTER**.
- Enter **ALARM TIME** (Military Format).
- Press **ENTER**.
- Display confirms setting.
- Press **CANCEL** to return to main menu.

OR

- Press **END** to exit programming.

# Samsung Voicemail

This section describes how to setup and use the various features available to a Subscriber. A Subscriber is a person that has been authorized access to the various features and services available in the Samsung Voicemail. Please review this section carefully before you use your Authorized Features and Services, known as Subscriber Services.

Voicemail is one of the Subscriber Services available. Your voicemail box has the capability of storing private messages, and offers a number of options for sending or redirecting messages as well as provides several ways to notify you of new messages.

Another very common Subscriber Service is Access Manager. This allows you control over when and where you receive your calls as well as what to speak to your callers in the event you are unable to speak to them directly. The 'events' are referred to as "Call Conditions": No-Answer, Busy, and Blocked are the most commonly used Call Conditions.

This guide can be used by Subscribers from within the office or from telephones outside the office. The basic operation is the same, but the access method will be different. [See the Subscriber Services Menu Diagram for more details.](#)

Note that some features and prompts detailed here may not be available to all Subscribers. See your System Administrator if you have questions about feature availability.

## ACCESSING YOUR MAILBOX

*[Also known as Subscriber Services Menu]*

### Inside Callers *[Subscriber logging in from their Desk]*

- Dial the voicemail access number or press the key assigned to ring the voicemail **[VMMSG]**.
- Enter your personal password when prompted (the default password is 0000).

### Outside Callers *[Subscribers calling from Cell Phones or outside of the office environment]*

- Dial the phone number that will be answered by the voicemail. The main greeting will answer.
- At the main greeting dial **[#]** plus your Subscriber (or mailbox) number (Subscriber and Mailbox numbers will usually match your extension number).
- Enter your personal password when prompted (the default password is 0000).

### Access your Subscriber Services (or Mailbox) from a Station other than your Own (or checking a mailbox associated with a different station)

- Press the **[VMMSG]** key or dial the voicemail **group number**. You will be prompted to enter a password.
- Press **[\*]**. This will take you to the Main Auto Attendant Menu.
- Press **[#]** plus the Subscriber number of your choice. You will be prompted to enter your password.

At this point the inside and outside callers follow the same instructions. You will hear a message stating the number of messages left in your mailbox. You will then hear the Subscriber Services Menu with the following options:

- 1 Listen to New Messages - [See Listening to your Message.](#)**
  - 2 Record and Send Message - [See Sending Messages.](#)**
  - 3 Review Saved Messages - [See Listening to your Message.](#)**
  - 4 Access Manager - [See Access Manager.](#)**
  - 5 Personal Greetings - [See Personal Greetings.](#)**
  - 6 Mailbox Administration - [See Mailbox Administration.](#)**
- # Personal Services - [See Personal Services.](#)**
- \* Return to Main Menu.**

# Subscriber Services Menu

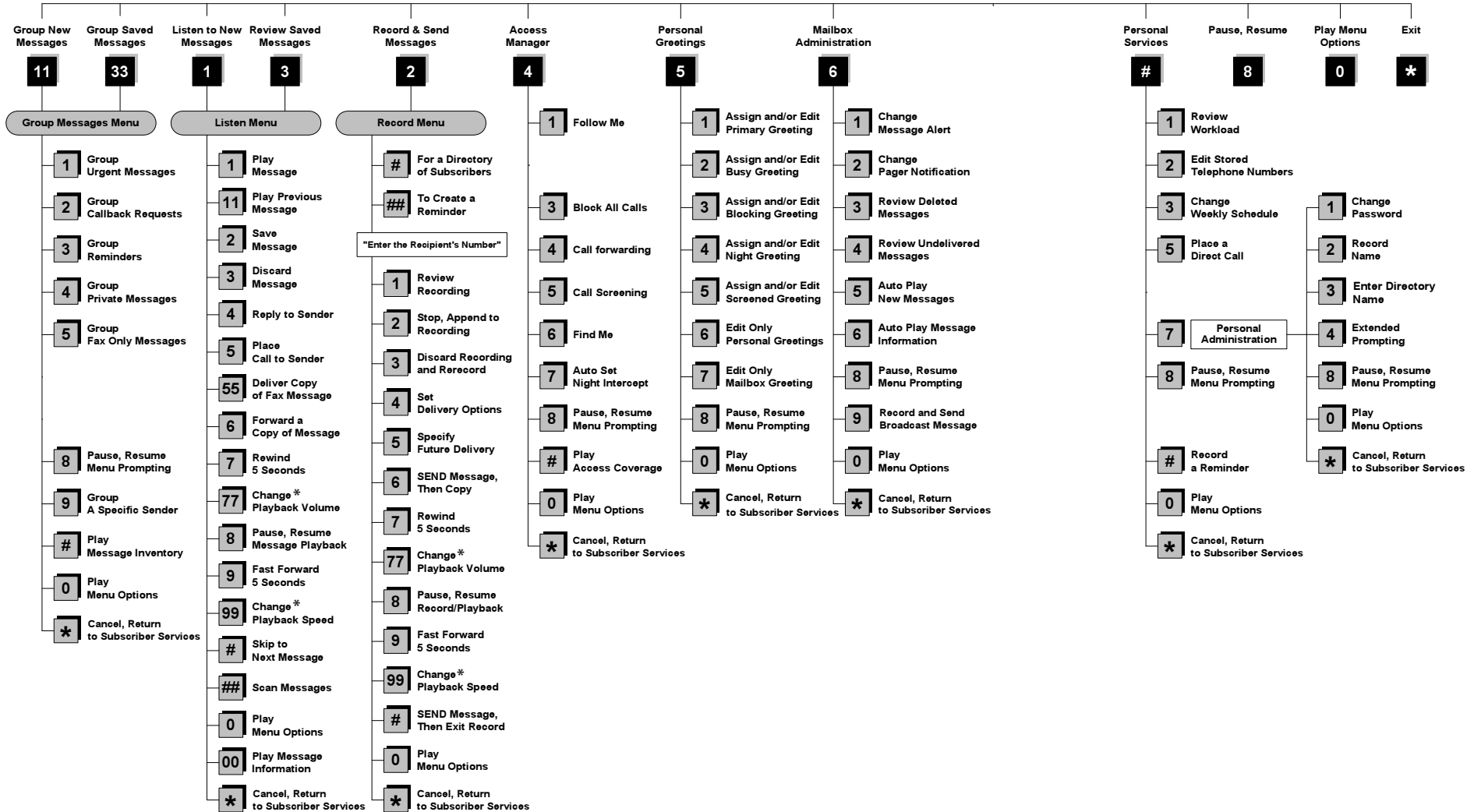

NOTE: All options shown MAY NOT be authorized. If an option is not available please speak to your system administrator.

\*Change Playback Volume and Speed not available on the OfficeServ 7030, OfficeServ 7100, OfficeServ 7200-S or OfficeServ IP-UMS.

## GETTING STARTED

Using your new Samsung Voicemail Subscriber Services is as simple as following a few simple spoken instructions. First time users should read this section as a tutorial. You should start with the following steps:

- Access your Subscriber Services Menu - You already know how to do this.

### From the Subscriber Services Menu:

- Record a Primary/No-Answer Personal Greeting. Dial **[5][1]**.
- Record a Mailbox Greeting. Dial **[5][7]**.
- Change your access code (Password). Dial **#[7][1]**.
- Record your name. Dial **#[7][2]**.
- Enter your directory name. Dial **#[7][3]**.

After you have completed the steps above your Subscriber Services are set up and ready to use.

## LISTEN TO YOUR MESSAGES

If there are new messages in your mailbox your **[VMMMSG]** key will be lit. Call the Samsung Voicemail by pressing this key, and when prompted enter your password. You will then be at the Subscriber Services Menu. Select **[1]** to listen to new messages or **[3]** to listen to saved messages.

Note: After you enter your password, if "Autoplay of New Messages" is enabled and you have new messages the Samsung Voicemail will begin to play them automatically. A subscriber can control this feature. From the Subscriber Services Menu **[6] [5]** toggles "Autoplay of New Messages" ON/OFF.

## SUBSCRIBER SERVICES MENU

The following is a list of all the options available in the Subscriber Main Menu.

- 1** LISTENING TO NEW MESSAGES
- 11** GROUP NEW MESSAGES
- 2** RECORD AND SEND A MESSAGE
- 3** LISTENING TO OLD MESSAGES
- 33** GROUP OLD MESSAGES
- 4** ACCESS MANAGER
- 5** PERSONAL GREETINGS
- 6** MAILBOX ADMINISTRATION
- 8** PAUSE / RESUME

- 0** PLAY MENU OPTIONS
- \*** EXIT TO AUTO ATTENDANT
- #** PERSONAL SERVICES

## 1 or 3

## LISTENING TO OLD OR NEW MESSAGES

- 1** Play / replay the message you just heard.
- 11** Play the previous message.
- 2** Save the message you just heard and listen to the next message.
- 3** Delete the message you just heard and listen to the next message.
- 4** Reply to the message.  
This will allow you to leave a message in the mailbox of the sender (if the sender has a mailbox on this system).
- 5** Return the call directly to the telephone number that left the message.  
This will work for internal and external callers, but Caller ID service is needed to use this feature on an outside call.
- 55** Deliver a fax copy.  
This will allow you to receive attached faxmail document(s). Faxmail documents can be delivered to any fax machine of your choice as long as out calling is authorized. You can also have faxmail messages automatically delivered to the fax machine of your choice.
- 6** Forward the message and saves a copy.  
The subscriber can be selected by dialing their mailbox number (nnn), using the directory service (#) or you may also add comments and leave it as a memo to yourself (##).  
The Send and Copy Service (option 6) allows a user to send copies of a message to multiple recipients easily. A different introduction message may be left for each recipient.
- 7** Rewind the message 5 seconds.
- 77** Change playback volume of the recording. **[Not available on OS 7030, OS 7100, OS 7200-S or OS IP-UMS]**  
There are two levels of volume during playback. Dialing this code will toggle between the two levels.
- 8** Pause or resume during message playback.
- 9** Fast forward the message 5 seconds.

**99** Change playback speed of the recording. **[Not available on OS 7030, OS 7100, OS 7200-S or OS IP-UMS]**

There are two levels of speed during playback. Dialing this code will toggle between the two speeds.

**0** Play options.

Pressing this key will play all the menu options available to you from this point.

**00** Hear the time and date, and sender's information of the message you just heard. Sender information is not available on outside calls.

**#** Move to the next message. This does not Save or Discard the current message - it is retained as new.

**##** Scan. Plays first 7 seconds of a message then skips to next message. This is similar to the scan button on a radio. It will allow you to find a specific message quickly. To stop scanning press **[1]**.

**\*** Cancel and return to previous menu.

**11** or **33**

## GROUP NEW OR OLD MESSAGES

Messages can be grouped as either Reminders, press **[3]** or Messages from a specific sender, press **[9]**.

Additionally you can press **[#]** and hear a summary of your mailbox contents:

- a) Number of messages
- b) Number of reminders
- c) Number of urgent messages
- d) Number of messages needing a callback
- e) Number of private messages
- f) Number of fax messages

**2**

## RECORD AND SEND A MESSAGE

This option is used to send a message to another subscriber. The steps are simple:

- a) Enter the recipient's mailbox number, or if this is not known enter **[#]** to use the system directory.

b) Record your message at the tone. After recording the message, you will hear the Send Menu with the following functions:

- 1** Review
- 2** Continue Recording
- 3** Discard and Re-Record
- 4** Set Message Attributes (Delivery Options)
- 5** Schedule Future Delivery
- 6** Save and Send then Send a Copy to Someone Else
- #** Save and Send the Recording

## Setting Message Attributes

If after recording a message you select **[4]** you can set up any combination of the following delivery options:

- 1** Urgent Delivery
- 2** Return Receipt Requested
- 3** Request a Call Back
- 4** Private Delivery
- 5** Reply Required
- \*** Exit

## Scheduling Future Delivery

If after recording a message you select **[5]** to schedule future delivery, you will be able to set message attributes and set this message as:

- #** Immediate Delivery
- 1** Next Few Hours
- 2** End of Current Business Day (based on your Availability Schedule)
- 3** Beginning of Next Business Day (based on your Availability Schedule)
- 4** A Coming Day of the Week
- 5** Specific Day / Time
- \*** Exit

**4**

## ACCESS MANAGER

The Access Manager allows the subscriber to set a number of options for when, where and how, and/or if the Samsung Voicemail contacts you when a caller dials your extension number. All of the options are toggled on/off based on their current status when you access them.

**Note: ALL** Access Manager options **MUST** be individually allowed by the System Administrator for each Subscriber. They are:

### 1 Follow Me

Allows the subscriber to enter an alternate location and set how long the new destination (Designated Location) will be active. This number may be an internal or external number. This is useful if you are frequently traveling or changing the number where you can be reached.

When Follow Me is activated, the transfer will be supervised and confirmed. This means that if the call is not answered or if rejected by the Subscriber at the designated location it will be recalled to the Subscriber's mailbox.

### 3 Call Blocking

When this feature is active, callers will not be transferred to your extension, they will hear your 'blocked' greeting (if recorded) and will go directly to your mailbox if they do not select any or are not offered any other options.

### 4 Call Forwarding

Unlike Follow Me where the subscriber wants to take their calls at an alternate location this feature allows the subscriber to pass control of his calls to another Subscriber. The "Forwarded To" Subscriber will now be in control of the caller and the caller will NOT return to originating Subscriber's Mailbox. If the "Forwarded To" Subscriber does not answer the caller it will now follow what ever the "Forwarded To" Subscriber has set up for their call conditions. The Caller will hear "Forwarding to" "{Subscriber Name}" before actually being forwarded.

### 5 Call Screening

If this is turned on, the caller will be asked their name and the Samsung Voicemail will play this name to you before the transfer, giving you an option to accept or reject the call.

### 6 Find Me

Find Me, when enabled, will attempt to locate the subscriber by calling a list of preprogrammed phone numbers. The stored phone numbers are entered in 'Personal Services' [#][2] (if allowed by the Administrator). The stored telephone number list can contain up to 9 preprogrammed telephone numbers. The Find Me feature only use the first five.

### 7 Night Intercept

This feature is dependent on your weekly availability schedule, which is entered in 'Personal Services' [#][3] (if allowed by the Administrator). When Night Intercept is active the Samsung Voicemail will first ring your extension then play your primary, No Answer greeting during the day (when you are

available) and will NOT ring your extension but simply play your Night greeting during the night (when you are not available).

**Note:** This does NOT use the Day and Night schedules of the phone system. It is solely controlled by the Subscriber's Availability Schedule.

### 8 Pause / Resume

### \* Exit from Access Manager

### 0 Play All Options

### # Play Access Coverage

This feature is useful for finding out how you current access settings are set. It will also tell you what greetings will play under each of the call conditions you have setup.

## 5

## PERSONAL GREETINGS

The options available in this menu will be determined by your System Administrator, and not all of them may be available to you. In the simplest systems, only a mailbox greeting will be available, additional greetings may be accessible in more complex systems.

Your Personal Greeting will be played every time someone dials your extension and you do not answer.

You may record up to 9 Personal Greetings, and you may assign any one of them to be active. There are several different 'Call Coverage' conditions to which you may assign any of your 9 greetings. The Call Coverage Conditions are: No-Answer, Busy, and Do Not Disturb (or Forwarded All). This will allow different greetings to play depending on the type of call forward that you have set, or the condition of your telephone.

The Call Coverage conditions that you can assign specific greetings to are selected by the following digits:

### 1 Primary/No Answer Greeting

Used when in your office, away from your desk or during the time period you are scheduled available. If this is the only Personal Greeting you record, it will play for all call coverage conditions.

This option is available only if the Administrator has assigned you the 'Basic Greeting' feature.

Example: "Hi this is John Smith. I'm sorry I am not available to answer your call. If someone else can help you, please enter the extension number now. Or, to leave me a message, press 1."

## 2 Busy Greeting

Played to a caller when you are already talking to someone on your extension or the telephone at your Designated Location.

This option is available only if the Administrator has assigned you the 'Busy Greeting' feature.

Example: "Hi, this is John Smith. I'm on another line right now. If someone else can help you, please enter the extension number now. Or, to leave a message, press 1."

## 3 Call Blocking Greeting

Used while Call Blocking is enabled in your Access Manager or if your phone is forwarded ALL or DND.

This option is available only if the Administrator has assigned you the 'Call Blocking' feature.

Example: "Hi, this is John Smith. Sorry I missed your call, but I'm going to be out of the office for the next few hours. If someone else can help you, please enter the extension number now. Or, to leave me a message, press 1."

## 4 Night Greeting

Used during the time period you are scheduled UNAVAILABLE, usually after business hours during the evening and at night.

This option is available only if the Administrator has assigned you the 'Scheduling' feature.

Example: "Hi, this is John Smith. I've left the office for the evening. If you would like to try someone else, please enter the extension number now. Or, to leave me a message, press 1."

## 5 Call Screening Greeting

Used while Call Screening is enabled, and you REJECT a caller after listening to the caller's record name.

This option is available only if the Administrator has assigned you the 'Call Screening' feature.

Example: "Hi, this is John Smith. I'm sorry, but I am not available to speak with you at this time. If someone else can help you, please enter the extension number now. Or, to leave me a message, press 1."

## 6 Edit Personal Greetings

You may also edit/record each one of the greetings (1-9) at any time.

Select a greeting number to edit and follow the instructions to record your greeting. When you are done recording your greeting, you will be able to listen to the greeting you recorded, save the greeting you recorded and return to the previous menu, record the greeting again, or exit without saving the greeting.

Note: If you record only the greeting assigned to the No-Answer Call Coverage Condition, then that greeting will play to callers for all Call Coverage Conditions (No-Answer, Busy, Blocked, Night, and Rejected Caller). In this case, the salutation part of the greeting should be very general.

## 7 Edit Mailbox Greeting

Used whenever a caller reaches your mailbox or if you have not recorded any of the Call Coverage greetings. The way a caller is transferred to your mailbox greeting directly, is by another subscriber transferring the caller to your mailbox using the VT (VoiceMail Transfer) key.

This option is available only if the Administrator has assigned you the 'Mailbox Greeting Option' feature.

Example: "Hi, this is John Smith. Please leave me a message, I will call you as soon as I can."

Note: This greeting will only play if none of the 5 personal greetings has played to the caller. A common usage for this Greeting is when another Subscriber is talking with a caller and uses the VT key on their phone to transfer the caller directly to your Mailbox.

# 6

## MAILBOX ADMINISTRATION

The Mailbox Administration menu is used to turn on and off your pager notification, message alert options and other message control features.

### 1 Message Alert

When this function is activated, the Samsung Voicemail will call any outside or inside telephone number, after each message is left in your voice mailbox.

To hear your message at the remote location when the Samsung Voicemail calls you, after you pick up the telephone and answer you will be instructed that there is a message and to enter your password. Simply enter your password and you will now be logged in.



### Setting Up Message Alert:

- From the Subscriber Services Menu press **[6]** for Mailbox Administration.
- Press **[1]** for Message Alert.
- There are 4 options available to you:
  - Press **[1]** to toggle message alert on and off.
  - Press **[2]** to set the schedule when you would like to be notified.
  - Press **[3]** to be notified on urgent messages only.
  - Press **[4]** to set the destination phone number.

## 2 Pager Notification

When this function is activated, the Samsung Voicemail will call your beeper service and notify you after each message is left in your voice mailbox.

- From the Subscriber Services Menu press **[6]** for Mailbox Administration.
- Press **[2]** for pager notification.
- There are 4 options available to you:
  - Press **[1]** to toggle pager notification on and off.
  - Press **[2]** to set the schedule when you would like to be paged.
  - Press **[3]** to be notified on urgent messages only.
  - Press **[4]** to set the pager phone number.

## 3 Undelete

When this function is activated, the Samsung Voicemail will allow you to undelete any messages that you have recently deleted (up to the programmed Daily Maintenance Time, which is set to 3 a.m. by Default the following morning).

- From the Subscriber Services Menu press **[6]** for Mailbox Administration.
- Press **[3]** for Deleted Messages.

Deleted voicemail messages are temporarily stored in memory until 3 a.m. the following day. Select this option to recover ("undelete") previously deleted messages, during this period of time.

## 4 Undelivered Retrieval

When this function is activated, the Samsung Voicemail will allow you to recall any messages you have sent that have NOT yet been picked up by the recipient.

- From the Subscriber Services Menu press **[6]** for Mailbox Administration.
- Press **[4]** for Undelivered Messages.

This useful feature will allow you to cancel any messages that have NOT yet been picked up by the recipient.

## 5 Auto Play New Messages

If this option is enabled, after you enter your password correctly any new messages will immediately begin to play. To enable (or if already enabled toggle and disable) this feature:

- From the Subscriber Services Menu press **[6]** for Mailbox Administration.
- Press **[5]** to Set Auto Play of New Messages.

## 6 Auto Play Message Information

If this option is enabled, the date, time and sender's name will be played automatically before each message. If this is disabled, the information must be requested manually by pressing '00'. To enable (or if already enabled toggle and disable) this feature:

- From the Subscriber Services Menu press **[6]** for Mailbox Administration.
- Press **[6]** to Set Auto Play of Message Information.

# 9

## MESSAGE BROADCAST

This option will only be available if it has been allowed by the System Administrator.

### Broadcast to All Mailboxes

If you have been designated as a Subscriber Administrator, you may send a message to ALL mailboxes in the system.

- From the Subscriber Services Menu press **[6]** for Mailbox Administration.
- Press **[9]** for Broadcast Messages.

This option will only be available if your mailbox has been assigned Subscriber Administration privileges.



## PERSONAL SERVICES

The Personal Administration Menu is used to set your password and record your name. Many of these features must be allowed by the System Administrator.

### 1 Workload Management

Allows you to access to all reminders, both Active and Pending. If authorized you can group your reminders as Commitments, Follow-Ups or Tasks for better organization. The system will flag each reminder as Active or Pending (pending means scheduled for future delivery).

### 2 Stored Numbers

Allows you to enter up to 9 stored phone numbers. The first five of these are used in the 'Find Me' feature, but any of them (1-9) can be easily dialed using only one digit followed by the pound key, to be used by many other features from within your subscriber space. (ie: "Follow Me," "Message Alert," "Pager Alert," and "Direct Call").

### 3 Schedule Availability

Allows you to enter a weekly availability schedule for use with Night Personal Greeting and the Auto Night Intercept feature. Follow the spoken directions to enter the days of the week and times you are generally available to talk to your callers. All other times you will be considered unavailable.

### 5 Place a Direct Call

Allows you to place a direct call out of the Samsung Voicemail from anywhere. You may either dial the number or dial a single digit 1-5 that corresponds to a stored number ([See Personal Services, 2 - Stored Numbers](#)). This feature must be authorized by the System Administrator and can be limited or opened to internal, local, and long distance calls.

### 7 Personal Administration

This area is used during the initial set up of your Subscriber Settings ([see next section](#)).

## PERSONAL ADMINISTRATION SETTINGS

This menu allows you to make changes to basic setup settings, that are rarely changed. Use these when you initially set up your personal Subscriber settings. You probably will not need to change them after that.

### 1 Setting your Password

- From the Subscriber Services Menu press **[#][7][1]**.
- The current password will be played and you will have the chance to change it.

### 2 Recording your Name

Use this option to record your name. Your recorded name is played in several different situations. It is important to record your name for proper operation of the Samsung Voicemail system.

- From the Subscriber Services Menu press **[#][7][2]**.
- The current name will be played and you will have the chance to change it.

Note: It is possible that if you do not record your name and/or enter your Directory Name (described below), you will not be included in the Dial by Name Directory.

### 3 Entering your Directory Name

Use this option to enter your Directory Name. Your Directory Name is used by callers to find you if they do not know your extension number.

- From the Subscriber Services Menu press **[#][7][3]**.
- The current Directory Name will be played as a string of digits that are equal to your name spelled out on your telephone keypad. Follow the instructions to enter a new name. You will be prompted to enter your last name and then your first name.

This must be done in order for the directory feature to work correctly.

Note: It is possible that if you do not record your name (described above) and/or enter your Directory Name, you will not be included in the Dial by Name Directory.

### 4 Extended Prompting

Use this option to drastically reduce the number of prompts played in the subscriber interface (mailbox prompts). Change this setting only if you are very familiar with the user operation of the Samsung Voicemail.

Note: Remember if you know what digits to press, you can enter them at any time you do not have to wait to be prompted. This feature can be toggled on/off at anytime. Also if it is off you will be prompted within each subscriber menu to press zero for more options. This enables you to still be able to find out what to do if you were to get lost and extended prompting was disabled.

## KEYSET USER FEATURES

The following options are available if you have a display keyset. They require setup by the System Administrator.

### Message Waiting Lights

When new messages are left in your mailbox, the voicemail message light on your keyset will flash. Press this flashing key [**VMMMSG**] and follow the prompts to retrieve messages. This key may be pressed at any time to log into your Subscriber Main Menu.

### Answer Machine Emulation

If you have an Answer Machine Emulation key programmed on your keyset, you can use it to monitor calls going to your voicemail, and optionally answer them. The operation of this feature is similar to screening a call on a home answering machine.

Your keyset must be set to forward on no answer to voicemail. After ringing your station the caller will be connected to your voicemail and hear your personal greeting before leaving a message. During this time you will be monitoring the connection between the caller and your voicemail box. At this time you will only be monitoring the call, you can not talk to the other party until you answer. You may pick up the call at any time or ignore it.

To activate this feature press the **AME** button. The associated indicator will be lit steady. Press again to turn off. If this key is pressed while a station is ringing (during forward no answer), the feature will be turned on for the current call only.

While the caller is leaving a message or ringing you may:

- Press [**#**] to immediately put the caller in your voice mailbox and monitor it.
- Press [**\***] to immediately disconnect your station. The caller continues to leave a message normally.
- Pick up the handset and monitor privately.
- Press **ANS / RLS** to answer the call (using the handset or speaker).

## AME Password

If your keyset has **AME PASSWORD** (MMC 110) set to **YES**, you must enter your station password to listen to messages being left. This will prevent unauthorized people from listening to messages being left for you.

If the password option is turned on, while a message is being left, press the flashing **AME** indicator and enter your station password (not your SVMi E-Series password). You will then hear the message being left.

## Call Record

If you have a call record button assigned to your phone, you may press it at any time, to record the conversation in progress. If you have a display keyset, you will also have the soft key options to pause and time the message.

## SHORTCUTS

### Calling

Calling a station that is busy or does not answer you can press [#] to immediately send the call to the called parties mailbox.

### Call Divert to Voicemail

While receiving an incoming (ringing) call, dial [\*] to immediately send the caller to your personal voicemail box. This will override the call forward no answer setting.

### Direct Messaging

[#] + **DSS** To make it easy to leave messages for others in your office without having to dial their extension number first, keyset users may simply dial [#] plus a mailbox (extension) number and leave a message directly. If you dial a busy extension press [#] to connect directly with the mailbox.

### Self Memo (Reminder)

Pressing [##] will leave a message in your own mailbox. This is useful to remind yourself of things to do now or in the future. Messages can be sent with future delivery so you can have the system call you when items become due.

## INTERACTIVE DISPLAYS

Display keyset users have the added advantage of using the soft keys and displays to play, save, delete, reply, call, forward, rewind, pause, fast forward, change the volume, get message information, or help.

### Viewing Mailbox Contents

If you have new messages, in addition to the Terminal Status Indicator (TSI) you will be able to use the keyset displays and soft keys to communicate with the Samsung Voicemail.

## E-MAIL GATEWAY (EMG)

The E-Mail Gateway feature integrates your voice mail box with your email client. No matter what email client software you are using or where you use it, you can send voice mail messages and fax mail messages to your E-Mail inbox.

There are two parts to the E-Mail Gateway; E-Message Delivery and E-Message Notification.

1. **E-MESSAGE DELIVERY:** Voice mail messages (.wav) and/or fax mail messages (.tiff) are "delivered" to your Inbox with the appropriate attached file.
2. **E-MESSAGE NOTIFICATION:** You will receive an e-mail, with NO attachments, notifying you that you have a voice and/or fax mail message in your Voice Mail Box.
  - As a subscriber you can use either E-Message Delivery and/or E-Message Notification.
  - As a subscriber you can have multiple e-mail addresses. (a maximum of 5 valid email addresses).
  - E-Message Notification can be set to one e-mail address while E-Message Delivery is set to different e-mail address.

## Functionality

- With either type of EMG, when Caller ID (CID) is provided, the callers telephone number will appear in the subject field of the email along with the date and time stamp of when the voice message was originally recorded in your Voice Mail Box.
- If the caller is also a subscriber on the system and the E-Mail Gateway is set up with a valid "Reply To" address, the Subscriber's name will also appear in the "From" field. Otherwise, the "From" field will display the name of the Samsung voice mail system (SVMi-8E, SVMi-16E, or SVMi-20E) sending the message.
- Client will use their PC's Multi-Media kit (equipped with either speakers and/or a headset) to listen to messages delivered to their e-mail Inbox.

**IMPORTANT NOTE:** If the PC/Laptop/PDA/Smart Phone/etc... is not equipped with hardware and software capable of playing a '.WAV' file then the E-Mail Gateway will not work for them until they add some method to listen to '.WAV' files delivered to their Inbox.

The same applies to Fax Mail messages, if the device the subscriber is using does not support the viewing of '.TIFF' files, then the E-Mail Gateway for Fax Mail will not work for them until they add some method to view .tiff files delivered to their inbox.

- No Synchronization of messages is performed between the Voice Mail Box and the E-mail Inbox.
  - Messages listened to, forwarded, deleted, and/or saved within an e-mail inbox will NOT effect the status of that same new message in the Voice Mail or the MWI (Message Waiting Indicator) associated with that message on the phone.
  - Also messages listened to in the Voice Mail, from a phone, will not change the Unread/Read status of the same message in an e-mail inbox.

- However, the Voice Mail Administrator can adjust parameters per subscriber or group of subscribers that decide how, when, or if to delete the original voice message after it is sent to the E-Mail Server.
- When full synchronization of messages between Voicemail Box and E-mail Inbox is required, ask your Samsung representative about the OfficeServ IP-UMS. This is an Internet Protocol based fully synchronized Unified Messaging System.

## Benefits

- Store and Archive Voice and Fax Mail Messages in visible folders.
- Voice and Fax Mail Messages can now easily be dragged and dropped into folders the same way e-mail messages are organized and saved.
- Voice and Fax Mail Messages are now essentially the same as any other e-mail message.
- Backups and Message Archives can be made when they are made for all other types of e-mail messages.
- Add text notes and comments to use for reference later.
- Some (if not all) e-mail clients will allow you to edit the body of the e-mail to add comments.
- Some will allow you to edit the subject field to help you find a particular message quickly in a large archive of messages.
- Call Back Numbers and Date & Time Stamp are easily displayed in the Subject field.
- Easily forward Voice messages received, to others even if they are not a Voice Mail Subscriber on your system.
- No EMG System or Client Software to load on your Local PC or Network Servers.

Therefore compatible with most:

- E-Mail providers and E-Mail Clients
- PCs, Laptops, PDA, and/or Smartphones

**NOTE:** If you are not sure you have this functionality on your system and you would like to use it, please contact your on Site system administrator to see if it is available.

## PERSONAL SPEED DIAL NUMBERS

CODE	NAME	TELEPHONE NUMBER
00	_____	_____
01	_____	_____
02	_____	_____
03	_____	_____
04	_____	_____
05	_____	_____
06	_____	_____
07	_____	_____
08	_____	_____
09	_____	_____
10	_____	_____
11	_____	_____
12	_____	_____
13	_____	_____
14	_____	_____
15	_____	_____
16	_____	_____
17	_____	_____
18	_____	_____
19	_____	_____
20	_____	_____
21	_____	_____
22	_____	_____
23	_____	_____
24	_____	_____

# PERSONAL SPEED DIAL NUMBERS

CODE	NAME	TELEPHONE NUMBER
25	_____	_____
26	_____	_____
27	_____	_____
28	_____	_____
29	_____	_____
30	_____	_____
31	_____	_____
32	_____	_____
33	_____	_____
34	_____	_____
35	_____	_____
36	_____	_____
37	_____	_____
38	_____	_____
39	_____	_____
40	_____	_____
41	_____	_____
42	_____	_____
43	_____	_____
44	_____	_____
45	_____	_____
46	_____	_____
47	_____	_____
48	_____	_____
49	_____	_____

## System Feature Codes

### Line Groups

- 9 Local/LCR
- 800 \_\_\_\_\_
- 801 \_\_\_\_\_
- 802 \_\_\_\_\_

### Station Groups

- 501 \_\_\_\_\_
- 502 \_\_\_\_\_
- 503 \_\_\_\_\_
- 504 \_\_\_\_\_

### Paging Zones - Dial 55 plus

- 0 All Internal Zones
- 1 \_\_\_\_\_
- 2 \_\_\_\_\_
- 3 \_\_\_\_\_
- 4 \_\_\_\_\_
- 5 \_\_\_\_\_
- 6 \_\_\_\_\_
- 7 \_\_\_\_\_
- 8 \_\_\_\_\_
- 9 All External Zones
- \* All External Zones and Internal Zone 0

### Programmed Messages - Dial 48 plus

- 00 Cancel Message
- 01 In A Meeting
- 02 Out On A Call
- 03 Out To Lunch
- 04 Leave A Message
- 05 Page Me
- 06 Out Of Town
- 07 In Tomorrow
- 08 Return Afternoon
- 09 On Vacation
- 10 Gone Home
- 11 \_\_\_\_\_
- 12 \_\_\_\_\_
- 13 \_\_\_\_\_
- 14 \_\_\_\_\_
- 15 \_\_\_\_\_
- 16\* \_\_\_\_\_
- 17\* \_\_\_\_\_
- 18\* \_\_\_\_\_
- 19\* \_\_\_\_\_
- 20\* \_\_\_\_\_

### Feature Access Codes

- 10 + xxx Pick Up A Parked Call
- 12 + xxx Pick Up A Held Call
- 13 Door Lock Release
- 16 + xxx Speed Dialing
- 17 Save And Redial Number
- 18 New Call (Recall)
- 19 Last Number Redial
- 400 Cancel Do Not Disturb
- 401 Set Do Not Disturb
- 42 + xxx Cancel Message Wait
- 43 Return Message
- 44 Callback
- 45 Busy Station Camp-On
- 46 Conference
- 47 Account Code
- 48 + xx Programmed Messages
- 49 Send Flash To C.O. or PBX
- 53 + xxx In/Out of Group
- 54 Meet Me Page
- 56 Meet Me Page Answer
- 600 Cancel All Call Forward
- 601 + xxx Set Forward All Calls
- 602 + xxx Set Forward Busy
- 603 + xxx Set Forward No Answer
- 604 + xxx Set Fwd Busy/No Answer
- 605 + xxx Set Forward on DND
- 606 + xxx Set Forward Follow Me
- 65 + xxx Pick Up Ringing Extension
- 66 + xx Group Call Pick Up
- 67 Universal Answer
- \* Authorization Code

\*Programmed Messages 16-20 not available on OfficeServ 7030, 7100, 7200-5



# ITP-5107S

## IP Keypad User Guide

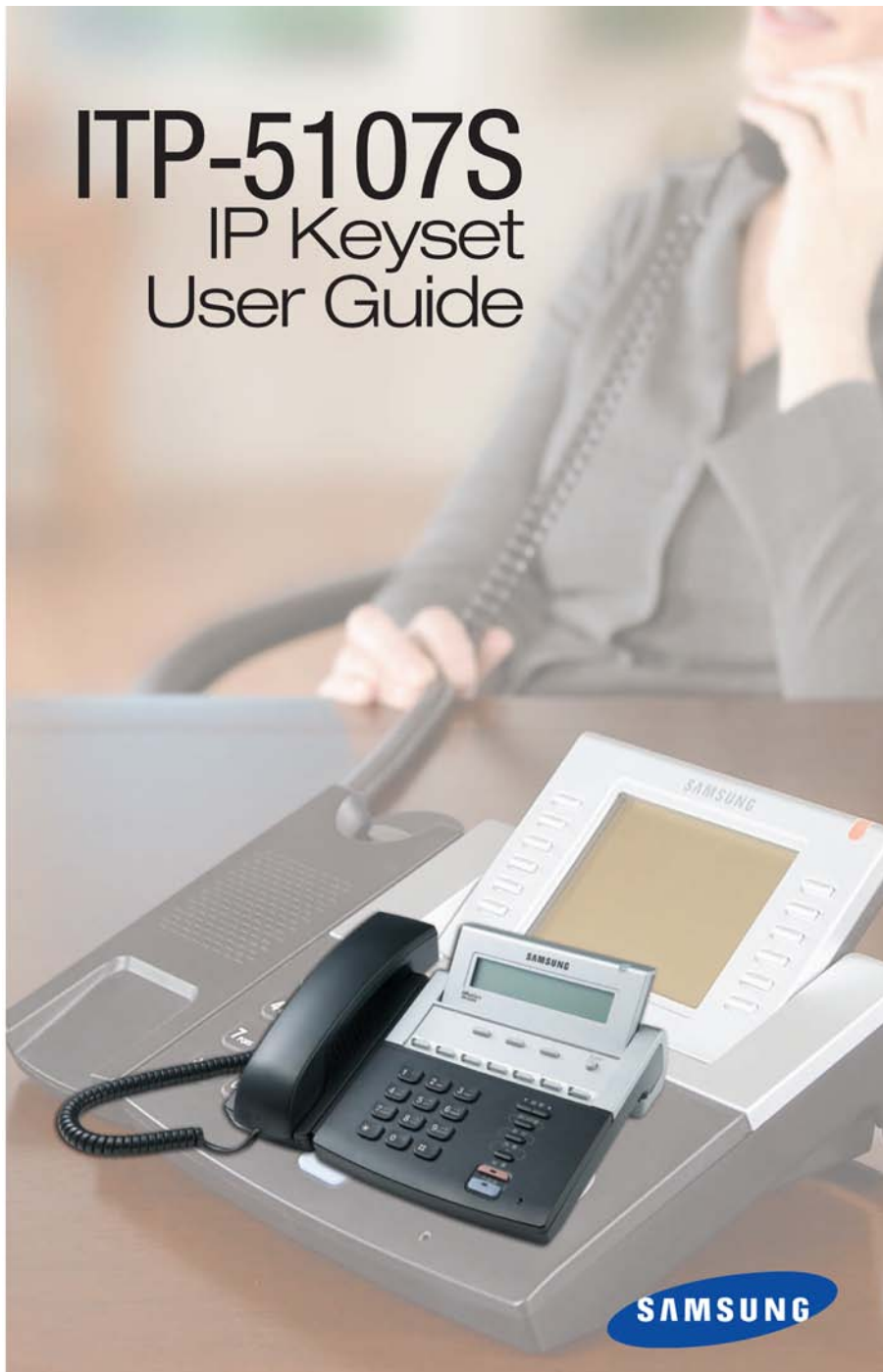

Enterprise IP Solutions

# OfficeServ™

ITP-5107S User Guide

*For OfficeServ™ 100, OfficeServ™ 500,  
OfficeServ™ 7000 Series*

# TABLE OF CONTENTS

<b><u>ABOUT THIS BOOK</u></b> .....	1
<b><u>THINGS YOU SHOULD KNOW</u></b> .....	2–6
<b><u>ASSEMBLING YOUR KEYSET</u></b> .....	7
<b><u>ITP-5107S SETUP</u></b> .....	8–14
<b><u>OUTSIDE CALLS</u></b>	
<u>Making an Outside Call</u> .....	15
<u>Answering an Outside Call</u> .....	15
<u>Universal Answer</u> .....	15
<u>Recall/Flash</u> .....	16
<u>Busy Line Queuing with Callback</u> .....	16
<u>Canceling Callback</u> .....	16
<b><u>INTERCOM CALLS</u></b>	
<u>Calling Other Stations</u> .....	17
<u>Answering Intercom Calls</u> .....	17
<u>Answer Modes</u> .....	17
<u>Busy Station Callback</u> .....	18
<u>Busy Station Camp-on</u> .....	18
<u>Calling Your System Operator</u> .....	19
<b><u>CALL PROCESSING</u></b>	
<u>Holding Calls</u> .....	20–21
<u>Transferring Calls</u> .....	21–22
<u>Transfer with Camp-On</u> .....	22
<u>Transfer to Voicemail</u> .....	22
<u>Call Waiting</u> .....	22
<u>Conference Calls</u> .....	23
<u>Forwarding Calls</u> .....	24–25
<u>Call Pickup</u> .....	26
<u>My Group Pickup</u> .....	26
<u>Privacy Release</u> .....	27

Copyright 2007-2009 Samsung Telecommunications America.

All rights reserved. No part of this manual may be reproduced in any form or by any means—graphic, electronic or mechanical, including recording, taping, photocopying or information retrieval systems—without express written permission of the publisher of this material.

Samsung Telecommunications America reserves the right without prior notice to revise information in this guide for any reason. Samsung Telecommunications America also reserves the right without prior notice to make changes in design or components of equipment as engineering and manufacturing may warrant. Samsung Telecommunications America disclaims all liabilities for damages arising from the erroneous interpretation or use of information presented in this guide.



## **DIALING FEATURES**

Speed Dialing .....	28
Programming Personal Speed Dial Numbers .....	28–29
One Touch Speed Dialing .....	29
Last Number Redial .....	29
Manual Retry with Redial .....	30
Save Number with Redial .....	30
Chain Dialing .....	30
Automatic Redial/Retry .....	30
Pulse to Tone Changeover .....	31
Memo Redialing .....	31

## **PAGING AND MESSAGING**

Making an Internal Page .....	32
Making an External Page .....	32
All Page .....	32
Meet Me Page .....	33
Call Park and Page .....	33
Messages—Set and Cancel .....	34
Returning Messages .....	34
Programmed Messages .....	35

## **CONVENIENCE FEATURES**

Logging In and Out .....	36
Do Not Disturb .....	36
One Time DND .....	36
Mute .....	37
Background Music .....	37
Established Call Pick-Up .....	37
Appointment Reminder/Alarm Clock .....	37
Door Phone Calls .....	38
Executive/Secretary Hotline .....	38
Executive Divert .....	38
Group Listening .....	39
Account Codes .....	39
Locking Your Keypad .....	40
Manual Signalling .....	41
Off-Hook Voice Announce .....	41
OHVA Block .....	42
OHVA Reject .....	42
In Group/Out of Group .....	42

## **CUSTOMIZING YOUR KEYSSET**

AME Password .....	43
Auto Camp-On .....	43
Select Ring Tone .....	43
Change Your Passcode .....	43
Set Answer Mode (Intercom) .....	44
Set Answer Mode (CO) .....	44
Automatic Hold .....	44
Headset Operation .....	44
Hot Keypad .....	45
Key Confirmation Tone .....	45
Rejoining a Page .....	45
Ring Preference .....	45
Auto Answer CO Calls .....	46
Display Speed Dial Name .....	46
Caller ID Review All .....	46
Secure OHVA .....	46
Configure Mobile Extensions (MOBEX) .....	47–48

## **DISPLAY FEATURES**

Interactive Display Keys .....	49
Directory Information .....	49
Call Log .....	50
Dial by Name .....	50
Call Progress Displays .....	51
Display Number Dialed .....	51
Call Duration Timer .....	51
Auto Timer .....	51
Timer Function .....	51
Viewing Message Indications .....	52
Alarm Reminder Messages .....	52–53
Personal Speed Dial Names .....	53
Station Names .....	53
Managing Key Assignments .....	54
LCR with Clear .....	54
Backspace with LCR .....	54
Text Messaging .....	55–56
Caller ID .....	57–61
ANI .....	58–61
CLI .....	58–61

<b>Samsung Voicemail</b> .....	62
Accessing your Mailbox .....	63
Subscriber Services Menu Diagram .....	64–65
Getting Started .....	66
Listen to your Messages .....	66
Subscriber Services Menu .....	66
Listening to Old or New Messages .....	67
Group New or Old Messages .....	68
Record and Send a Message .....	68
Access Manager .....	69
Personal Greetings .....	71
Mailbox Administration .....	73
Message Broadcast .....	75
Personal Services .....	76
Personal Administration Settings .....	77
Keypad User Features .....	78
Shortcuts .....	80
Interactive Displays .....	80
E-Mail Gateway (EMG).....	80–81

<b>PERSONAL SPEED DIAL NUMBERS</b> .....	83–84
--	-------

## ABOUT THIS BOOK

Samsung's new OfficeServ Technology keyset model, ITP-5107S, is part of the OfficeServ 100, OfficeServ 500, and OfficeServ 7000 Series.

The ITP-5107S IP keyset represents a new concept of Internet phone, in that it uses an IP address to Send/Receive voice and data. For voice communications, the ITP-5107S uses the data network line already in place in most offices and increasing number of homes.

The ITP-5107S keysets incorporate an LCD screen, which provides important information for the user, to make using the keyset easier and more convenient.

Your keyset is the most visible part of your telephone system. Please take the time to study this guide and to become familiar with the operation of your keyset. Keep this guide handy, as you may need to look up instructions for infrequently used features.

Learning to use your keyset correctly will make everyday telephone communications a breeze.

This book is written based on the factory default settings for the feature access codes. Sometimes, due to programming requirements, these codes may be changed. If you find that a feature code does not work as described in this book, please contact your installation and service company to determine the correct code.

# THINGS YOU SHOULD KNOW

## USER ORIENTATION

The ITP model telephones are called IP keysets. The IP keyset incorporates buttons or “keys” that are used to access or activate the many features of your office phone system. The ITP-5107S keyset incorporates 7 programmable buttons. Any of the system features or functions can be programmed to these buttons.

The three buttons above the row of programmable buttons are soft keys. These buttons assist in the use of the system features and functions.

Lines from the telephone company are “C.O. lines.” Calls on these lines are referred to as “outside calls.” Your system can have individual C.O. line keys or lines may be assigned to groups. When they are in a group, you access a line by dialing an access code or pressing a route button. For example, dial 9 or press a “LOCAL” button to get a local outside line. If Least Cost Routing is used, pressing the “LCR” button will automatically select a preprogrammed C.O. line according to what digits are dialed. Each line in the system is numbered, beginning with 701, then 702, 703, etc.

Direct Station Selection (DSS) buttons are programmed to ring specific stations. You can press a DSS button instead of dialing the extension number.

## CALL INDICATIONS

The buttons on your phone have light emitting diodes (LEDs). These are tri-colored LEDs that light green, red or amber (green and red together).

Intercom calls, also called internal calls, always appear on your CALL buttons. They will always light green. You can have up to eight CALL buttons, but at least two are recommended.

Outside calls appear on individual line buttons if they are assigned. When an individual line is not assigned to its own button, it will appear on a CALL button.

Your outside calls will light green on your keyset and red on other keysets. You never lose sight of your calls while they are on hold. They stay right where you put them and are identified with a green flashing light.

Some simple rules to remember:

- Any steady LED indicates the line or feature is in use.
- A fast flashing green LED indicates a new call ringing in.
- A slow flashing green or red LED indicates a call is on hold.
- A slow flashing amber LED indicates a recall to your keyset.

## FULL DUPLEX SPEAKERPHONE

All ITP keysets are speakerphones. Pressing the **FLASHING CALL BUTTON** will answer an incoming call on the speakerphone. Pressing the **SPEAKER** button will release the call on the speakerphone.

Switching from the handset to the speakerphone is easy. Simply press the **SPEAKER** button and hang up the handset.

## VOLUME CONTROLS

The ITP-5107S keyset uses the **UP** and **DOWN** buttons to adjust the ringer volume while the keyset is ringing, the speaker volume while the speakerphone is in use and the handset volume while you are listening. These three levels will be stored in memory until changed. If background music is turned on at your keyset, the volume buttons will also control the level of music. The volume of pages heard through the speaker of a keyset can be adjusted during a page announcement by using the volume buttons. There are 16 levels for each volume setting. The volume of off-hook ring is controlled by a user-programmable setting.

## TERMINAL STATUS INDICATOR

The terminal status indicator light is positioned on the top right corner of the keyset above the display. The terminal status indicator is a tri-colored (red, green, and amber) light that provides greater visibility of your keysets status than the individual button LEDs. The terminal status indicator provides the following indications:

- |                     |                                      |
|---------------------|--------------------------------------|
| • Busy/Off Hook     | Steady Red                           |
| • Intercom Ring     | Flashing Red                         |
| • Outside Call Ring | Flashing Green                       |
| • Recall Ring       | Flashing Amber                       |
| • Message Waiting   | Flashing Red                         |
| • Do Not Disturb    | Fast Flash Red at 1 Second Intervals |

## CONFERENCE BUTTON

The **CONFERENCE** button allows the user to set up a call with up to 5 parties (station or trunk).

## TRANSFER BUTTON

Transfer is used to send any call to another extension in one of two ways. You can do a screened transfer by informing the other extension who is calling or you can do a blind transfer without notification.

## HOLD BUTTON

The **HOLD** button maintains the call at your keyset, while enabling you to call other stations or consult coworkers in confidence.

## SPEAKER BUTTON

The **SPEAKER** button allows you to initiate a conversation from the keyset without lifting the handset or switch to speaker phone mode if you are currently on handset.

## FEATURE ACCESS CODES

This user guide is written based on the default access code for using system features. If the system numbering plan has been changed some of the access codes may not be correct. Your installing company can inform you of the correct codes.

## SYSTEM TONES

The system provides several tones to assist you. Some of these tones are already familiar to you.

Intercom Dial Tone—A steady tone that indicates you can begin dialing.

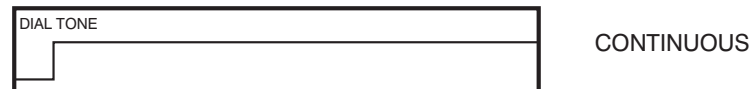

Ringback Tone—Indicates the station you dialed is ringing.



Busy Tone—Indicates the station you dialed is busy.



DND/No More Calls Tone—Fast busy tone indicates the station you dialed is in the Do Not Disturb mode or cannot receive any more calls.

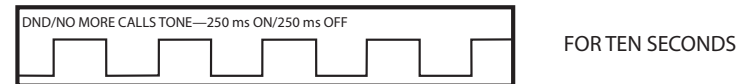

Transfer/Conference Tone—Indicates your call is being held and you can dial another party.

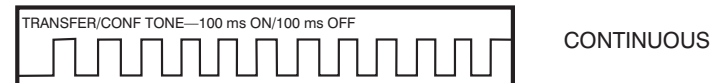

Confirmation Tone—Very short beeps followed by dial tone indicate you have correctly set or canceled a system feature.



Error Tone—A distinctive two level beeping tone indicates you have done something incorrectly. Try again.



# ITP-5107S



## ASSEMBLING YOUR KEYSSET

- Place the keyset face down on a flat surface.
- Insert notched ends of the support bracket into the channels located in the upper section of the bottom panel. Push towards the top of the keyset to lock in.
- Plug the handset cord into the jack marked with the  symbol.
- Route the handset cord out the **RIGHT** side of the keyset as you look at it face down.
- Plug an eight-conductor ethernet cable, from the wall, into the jack marked **LAN** on the back of the keyset. (Connect the ITP keyset to any port on the local network).
- Plug the power connector, from the power adapter provided, into the power jack on the back of the keyset. The power adapter is not required if the ITP is connected to a LAN connection that provides power over the ethernet. The ITP-5107S supports the power over ethernet feature when it is connected to a IEEE 802.3af compliant LAN switch or power injector port.

### IMPORTANT NOTE:

- To prevent damaging the keyset, only use the Power Adapter that came with the 5107S keyset.
- This manual assumes that the ITP keysets are connected to a functioning local IP network. The local IP network must be able to communicate with the main processor and MGI channel in the OfficeServ 100, OfficeServ 500, or in the OfficeServ 7000 Series systems over IP. This is assumed regardless of whether the IP keyset is on a local or remote network.

# ITP-5107S SETUP

## INITIALIZING THE ITP-5107S

Initially the ITP-5107S IP keyset will need to be setup to operate within the users network. The Setup Menu is also used to make changes to the keyset, in the event that the system information should change. The option chosen via scroll key will be highlighted.

The station numbers will be automatically set by the OfficeServ 100, OfficeServ 500, and the OfficeServ 7000 Series systems once the necessary information has been entered into the IP keyset. Enter ID and password of the server, as described below to register the phone.

See your system administrator for specific Network and Server addresses. The addresses necessary to set up the ITP-5107S are:

- IP Address of the ITP
- Network Gateway Address
- Subnet Mask
- IP Address of System's main processor
- User ID
- Password

## SETUP MENU

**TO GET TO THE SET-UP MENU, UNPLUG THE POWER FROM THE ITP-5107S PHONE OR UNPLUG THE LAN CABLE IF USING POWER OVER ETHERNET, PRESS AND HOLD THE \* BUTTON ON THE DIAL PAD WHILE PLUGGING IN THE POWER CORD OR LAN CABLE IF USING POWER OVER ETHERNET BACK INTO THE PHONE. NOW RELEASE THE \* BUTTON.**

>1. SYSTEM EASY WIZARD  
2. SYSTEM INFORMATION

Other items not shown on screen when scrolling down.

3. NETWORK SETUP  
4. LOAD & UPGRADE SETUP

5. SYSTEM SERVER SETUP  
6. PHONE SETUP

6. PHONE SETUP  
7. FACTORY RESET

7. FACTORY RESET  
8. REBOOT

## NAVIGATING THE MENUS

Once the IP setup menu is displayed, you can move to each menu by using the buttons as described below:

- The [0]~[9] dial buttons are used to directly choose a menu, or sub-menu options.
- The volume [▼]~[▲] buttons are used to move the cursor up or down to scroll through menu items.
- The **SPEAKER** button is used to select a menu item or to save data after entry. It functions as an "ENTER" or "OK" button.
- The **HOLD** button will take you out of the current sub-menu to one menu level up to previous screen. It functions as an "ESCAPE" or "CANCEL" button.
- In some entry fields, the **HOLD** button is used to backspace the cursor or to delete entered data.
- The [\*] button on the dial pad is used to enter [•] between IP address octets.

## MENU STRUCTURE

The IP SETUP MENU is configured as follows:

### 1. SYSTEM EASY WIZARD

This option will guide you through setting up all required parameters for connecting the ITP keyset to your system.

### 2. SYSTEM INFORMATION

1. Version Info: Provides boot rom, software, DSP, and hardware version information.
2. Network Info: Displays network mode, IP address of phone, network, and gateway information.
3. Netmask
4. Gateway

Note that items 2 to 4 are only displayed when setting Manual IP.

### 3. NETWORK SETUP

This menu allows you to individually setup the same parameters found in the Easy Wizard.

### 4. LOAD & UPGRADE SETUP

1. Upgrade TFTP Server: The IP address of the TFTP server containing the ITP software.
2. Upgrade Start: Starts the ITP software upgrade process.

### 5. SYSTEM SERVER SETUP

1. Server IP Address: The main processor's IP address.
2. Server ID: The ID assigned to your ITP (see your phone administrator for this information).
3. Server Pass: The password assigned to your ITP (see your phone administrator for this information).

### 6. PHONE SETUP

1. Idle Mode: Allow or Deny access to the Hot Desking (Idle Login) feature.

### 7. FACTORY RESET

This option resets ITP to factory default settings.

### 8. REBOOT

This option reboots the ITP.

## SETTING HOT DESKING (IDLE LOGIN)

Hot Desking allows you to log in and out of your ITP-5107S without rebooting.

- From the Main Menu, select **[6. PHONE SETUP]** to turn Hot Desking on or off.
- Select **[1. IDLE MODE]**
- Enter **1** to **allow** Hot Desking, Enter **0** to **deny** Hot Desking.
- Press **SPEAKER**.
- Press **HOLD**.

6. PHONE SETUP

1. IDLE MODE

IDLE MODE En(1)/Dis(0)  
0\_

## SETTING THE NETWORK PARAMETERS

Utilize the following programming steps to program the ITP-5107S keyset to operate within the users network. **YOU CAN SELECT THE SYSTEM EASY WIZARD TO PROGRAM ALL REQUIRED NETWORK PARAMETERS IF YOU WANT TO SET UP THESE PARAMETERS INDIVIDUALLY FOLLOW THE INSTRUCTIONS BELOW.**

### Network Parameter Setup

[Get into the SETUP MODE as shown on page 8.](#) From the Setup, Main Menu, select **[3. NETWORK SETUP]** to set or modify the network parameters. Scroll to this option using the volume [▼]~[▲] button and press **SPEAKER**.

Select the **Network Mode Setup** and press **SPEAKER**, the LCD will display this message.

3. NETWORK MODE SET UP

>1. MANUAL IP  
2. DHCP

- If **[1. MANUAL IP]** is selected, the user must enter the IP address of the IP keyset. Then enter the subnet mask, and gateway value for the customer network.
- If **[2. DHCP]** is selected, the IP address, subnet mask, and gateway value will be obtained automatically (if a DHCP server is present).

## Setting IP Manually

- From the "Network Mode Setup" Menu, select **[1. MANUAL IP]** and press **SPEAKER**. Next, press the **HOLD** button twice to get to the **NETWORK SETUP MENU** as seen here.

1. NETWORK MODE SET UP  
2. IP ADDRESS SET UP

Enter the IP keyset's IP address, the network's netmask and gateway as shown.

3. NETMASK SETUP  
4. GATEWAY SETUP

- Select the **[2. IP ADDRESS SET UP]** menu and press **SPEAKER**, the LCD will display this message and the user can enter its IP address.

INPUT IP ADDRESS & PRESS OK  
xxx. xxx. xxx. xxx

Check if there is any currently saved IP address of the phone on the LCD. If the IP address has not been set, the LCD displays nothing. The user can enter the IP address using [0]-[9] dial buttons and [\*] button for entering a "." Save that IP address by pressing the **SPEAKER** button. Use the **HOLD** button to backspace.

- Select the **[3. NETMASK SET UP]** menu and press **SPEAKER**, the LCD will display the following message and the user can enter a new Netmask IP address. Use the **HOLD** button to backspace.

INPUT NETMASK & PRESS OK  
xxx. xxx. xxx. xxx

Check if there is any currently saved subnet mask address of the phone on the LCD. If the subnet mask address has not been set, the display will show nothing. Press any dial buttons from [0]-[9] and [\*] button to enter the subnet mask IP address and then save that subnet mask IP address by pressing the **SPEAKER** button. Use the **HOLD** button to backspace.

- Select **[4. GATEWAY SET UP]** menu and press **SPEAKER**, the LCD will display the following message and the user can enter a new gateway address.

INPUT GATEWAY & PRESS OK  
xxx. xxx. xxx. xxx

Check if there is any currently saved Gateway IP address of the phone on the LCD. If the gateway IP address has not been set, the LCD displays nothing. The user can enter the gateway IP address by using [0]-[9] and [\*] button and can save that IP address by pressing the **SPEAKER** button. Use the **HOLD** button to backspace.

NOTE: In the **[3. NETWORK SET UP MENU]**, **[1. NETWORK MODE SETUP]** option, when **[2. DHCP]** is selected the IP address, Netmask, and Gateway will not be displayed on the **LCD**. Press **HOLD** to exit to Main Menu.

## Load and Upgrade Set/Modify

The fourth item **[4. LOAD & UPGRADE SET UP]** sets or modifies the IP phone's software version. Use extreme caution when upgrading the keyset. Only use this if you are upgrading your IP keyset firmware.

Select the **[4. LOAD & UPGRADE SET UP]** item and move to the lower level. The screen below is displayed.

1. UPGRADE TFTP SERVER  
2. UPGRADE START

Select option **[1. UPGRADE TFTP SERVER]** and enter the IP address of the TFTP server containing the ITP software. Use [0]-[9] and [\*] button to enter the IP address. Press **SPEAKER** to save.

Select option **[2. UPGRADE START]** and press **SPEAKER** to start the upgrade process. Press **HOLD** to exit.

## System Server Setup

From the Main Setup Menu, the fifth item **[5. SYSTEM SERVER SET UP]** sets or modifies settings related to registering the phone to the main processor. You can obtain this information from your system administrator. The screen below is displayed.

1. SERVER IP ADDRESS

You can set/modify the IP address of the main processor at the **[1. SERVER IP ADDRESS]** item. The screen below is displayed when you enter the item. The server IP is the IP address of the main processor.

INPUT SERVER IP ADDRESS  
xxx. xxx. xxx. xxx

You can confirm the current IP address of the main processor at the LCD panel. The address is left blank if it is not set. Use the dial buttons from **[0]-[9]**, and **[\*]** to set the IP address and press the **SPEAKER** button to save and exit. Select the **[2. SERVER ID]** menu. Use the **HOLD** button to backspace.

\* INPUT SYSTEM I D  
xxxx



You must input the ID assigned to your ITP phone. See your phone system administrator to get this value. Press the **SPEAKER** button to save and exit. Select the [3. SERVER PASS] item.

\* INPUT SYSTEM PASSWORD  
XXXX

You must input the password associated with your ID. See your phone system administrator to get this value. Press **HOLD** to backspace. Press the **SPEAKER** button to save and exit.

## Completion of Settings

From the main menu, select the seventh item [7. REBOOT] to save all modified settings and reboot the ITP-5107S phone.

# OUTSIDE CALLS

## MAKING AN OUTSIDE CALL

- Lift the handset and press an idle outside line button, line group button or dial a line access code to receive dial tone—**OR**—press an idle outside line button, line group button or dial a line access code to receive dial tone through the speaker—**OR**—press **SPEAKER**, receive intercom dial tone and dial a line access code.
- Dial the telephone number.
- Finish the call by replacing the handset.

NOTE: You will receive No More Calls tone when you attempt to make a call and there is no button available for that line.

- If Least Cost Routing is enabled on your phone system, this button may be labeled **LCR** or accessed by dialing an access code (usually **9**).
- If your system is programmed to require an authorization code before making a call, dial **\*** plus a valid code before selecting a C.O. line.
- If your system is programmed to require an account code before making a call, press the **ACC** button or dial **47** plus a valid bin number, press the **ACC** button again, or **\***, and then select a C.O. line. [See Account Codes for more information.](#)

For more information on authorization and account codes, see your system administrator.

NOTE: If the Hot Keypad feature has been turned off, you must first lift the handset or press the **SPEAKER** button before dialing.

## ANSWERING AN OUTSIDE CALL

- Lift the handset and you are automatically connected to the ringing call. [See Ring Preference under Customizing Your Keypad](#)—**OR**—press the **FLASHING CALL** button to automatically answer on the speakerphone.

NOTE: If a call is flashing at your keyset but not ringing, you must press the flashing button to answer.

## UNIVERSAL ANSWER

Outside lines may be programmed to ring a general alerting device. To answer calls ringing this device, dial **67** or press the **UA** button. This device can operate in any one of the six different ring plans.

NOTE: If the Hot Keypad feature has been turned off, you must first lift the handset or press the **SPEAKER** button before dialing.

## RECALL DIAL TONE

Press the **NEW** button to disconnect your existing call, wait for dial tone and then make a new call on the same line.

NOTE: If this button does not appear on your keyset, the **FLASH** button may be programmed to recall dial tone.

## SENDING A FLASH

While on an outside call, press the **FLASH** button to send a flash to the telephone company. This is required for some custom calling features or CENTREX use.

NOTE: Flash is not available on an ISDN circuit.

## BUSY LINE QUEUING WITH CALLBACK

If you receive a busy signal when you are selecting an outside line, this means that the line or group of lines is busy.

- Press the **CBK** button, if programmed, or dial **44**. You will hear confirmation tone.
- When the line becomes free, the system will call you back.
- Lift the handset to answer, wait for dial tone and dial the telephone number or speed dial number again.

NOTES:

1. A callback will be canceled if not answered within 30 seconds. If you have set a callback, your **CBK** button will light.
2. If the Hot Keypad feature has been turned off, you must first lift the handset or press the **SPEAKER** button before dialing.

## CANCELING CALLBACK

A callback will be canceled if not answered within 30 seconds. If you have set a callback, your **CBK** button will light.

Your phone may have a maximum of five callbacks to lines and/or stations set at a time. To cancel a callback:

- Press the **CBK** button, if programmed, or dial **44**. You will hear confirmation tone.
- While you are listening to confirmation tone, press the **HOLD** button. This will cancel the oldest set callback.

NOTE: If the hot keypad feature is turned off, you must first lift the handset or press the **SPEAKER** button before dialing.

# INTERCOM CALLS

## CALLING OTHER STATIONS

- Dial the extension number or group number.
- Wait for the party to answer. If you hear a brief tone burst instead of ringback tone, the station you called is set for Voice Announce or Auto Answer. Begin speaking immediately after the tone.
- Finish the call by replacing the handset.

NOTES:

1. If you have a **DSS** button assigned to an extension or station group, you may press this button instead of dialing the number.
2. If the Hot Keypad feature has been turned off, you must first lift the handset or press the **SPEAKER** button before you begin dialing.

## ANSWERING INTERCOM CALLS

- When your keyset rings, simply lift the handset—**OR**—press the **FLASHING CALL** button to be connected to the calling station.
- To finish the call, replace the handset.

[See Ring Preference under Customizing Your Keyset.](#)

## VOICE ANNOUNCE MODE

When another station calls you, your keyset will sound a brief attention tone and you will hear the caller's announcement.

- Press the **FLASHING CALL** button to turn on the microphone and speak handsfree—**OR**—lift the handset to reply.
- To finish the call, replace the handset.

NOTE: In order for C.O. calls to be answered handsfree, AUTO ANS CO must be set ON.

## AUTO ANSWER MODE

When another station calls you, your keyset will sound a brief attention tone and then automatically answer the call.

- Your microphone and speaker are turned on and you can speak handsfree. For privacy, use the handset.
- To finish the call, replace the handset.

NOTE: In order for C.O. calls to be answered handsfree, AUTO ANS CO must be set ON.

## BUSY STATION CALLBACK

When you call another station and receive a busy signal:

- Press the **CBK** button, if programmed, or dial **44**.
- When the busy station becomes free, your keyset will ring.
- Lift the handset to call the now idle station.

### NOTES:

1. A callback will be canceled if not answered within 30 seconds. If you have set a callback, your **CBK** button will light.
2. If the Hot Keypad feature has been turned off, you must first lift the handset or press the **SPEAKER** button before dialing.

## BUSY STATION CAMP-ON

When you call another station and receive a busy signal but you do not want to wait for a callback:

### MANUAL CAMP-ON

- Press the **CAMP** button or dial **45**.
- The called station will receive off-hook ring tone repeated every few seconds and its first available **CALL** button will flash green to indicate your call is waiting.
- Wait for the called party to answer.
- The called station must release its first call or place it on hold before answering your camp-on.

### NOTES:

1. If you receive No More Calls tone, that station has no available button to accept your call. Hang up or leave a message.
2. If the Hot Keypad feature has been turned off, you must first lift the handset or press the **SPEAKER** button before dialing.

### AUTO CAMP-ON

When you want to automatically camp on to a busy station without pressing the camp on button every time you call a busy station, you can set your phone for auto camp-on.

- With the handset on-hook, press **TRANSFER** and then dial **110**.
- Dial **081** to turn on auto camp-on or **080** to turn it off.
- Press **TRANSFER** to store your selection.

## CALLING YOUR SYSTEM OPERATOR

- Dial **0** to call your system operator or group of operators.
- If you want to call a specific operator, dial that person's extension number.

NOTE: If the Hot Keypad feature has been turned off, you must first lift the handset or press the **SPEAKER** button before you begin dialing.

# CALL PROCESSING

## SYSTEM HOLD

- When you are connected to any call, press **HOLD**. The call will flash green at your keyset. If this call appears on a line button at other keysets, it will flash red at those keysets.
- To take the caller off hold, press that button and the green flashing light will go steady green again. Resume the conversation.

NOTE: While on a call, pressing a line button, route button or flashing **CALL** button will automatically put your first call on hold and connect you to the new call. [See Automatic Hold under Customizing Your Keyset.](#)

## EXCLUSIVE HOLD

To place an outside call on hold at your phone so that other users cannot get it:

- Press the **HOLD** button twice. The call will flash green on your keyset and this line will show a steady red light on other keysets.
- To retrieve the call, press the flashing green line button or press the **HOLD** button a third time.

NOTE: Intercom calls will always be placed on exclusive hold.

## REMOTE HOLD

When you wish to place a call on hold at another station. Press **TRANSFER** and dial the station number (or press the appropriate DSS button). Press the **HOLD** button. This will place the call on system hold on an available CALL button or Line Button at the remote station and return you to dial tone.

NOTES:

1. If the destination station does not have any free CALL buttons or line buttons you will hear No More Calls tone and must return to the other party by pressing the **TRANSFER** button (or the RETURN soft key in the display).
2. Intercom calls cannot be remote held.

## HOLD RECALL

If you leave a call on hold longer than the hold timer, it will recall your station. The button that the call appears on will have a slow flashing amber light.

- When your phone rings, lift the handset or press the **FLASHING CALL** button to answer the recall.

- If you do not answer this recall within a pre-programmed period of time, it will go to the system operator.

## CONSULTATION HOLD

When you are talking on an outside line and it is necessary to consult with another extension:

- Press the **TRANSFER** button; you will receive transfer dial tone. Your call is placed on transfer hold.
- Dial the extension number.
- Consult with the internal party.
- Press **TRANSFER** to return to the outside party or hang up to transfer the call.

NOTE: Repeatedly pressing the **TRANSFER** button will toggle between the outside party and internal extension. If necessary you may disconnect either one of the parties by pressing the **DROP** button.

## RETRIEVING CALLS HELD AT ANOTHER STATION

When a line is on hold and it appears on your keyset, press the line button with the red flashing light.

When a line is on hold and it does not appear on your keyset, dial **12** plus the line number or the extension number of the station that placed the call on hold.

NOTE: If the Hot Keypad feature has been turned off, you must first lift the handset or press the **SPEAKER** button before you begin dialing.

## TRANSFERRING CALLS

Transfer is used to send any call to another extension in one of two ways. You can do a screened transfer by informing the other extension who is calling or you can do a blind transfer without notification.

- While on a call, press the **TRANSFER** button and dial an extension number or group number. Your call is automatically put on transfer hold. **OR** Press a **DSS** button or station group button. Your call is automatically put on transfer hold.
- Hang up when you hear ringing (this is an unscreened or blind transfer). **OR** Wait for the called party to answer and advise him/her of the call and hang up. If the transfer is refused, you will be reconnected to the outside line when the called station hangs up or you can press **TRANSFER** to return to the outside party. If you wish to send the call to another extension without waiting for the

first station to hang up, simply press another **DSS** button. **OR**  
Press the **CALL** button or C.O. line button to return to the outside party and begin the transfer process again.

When you are transferring a call to a keyset set for Voice Announce or Auto Answer, the transferred call will always ring.

#### NOTES:

1. After the inside party answers, you may alternate back and forth between the parties by pressing the **TRANSFER** button.
2. If you receive No More Calls tone, that station has no button available to receive another call. Press **TRANSFER** to return to the other party.
3. You cannot transfer an Intercom call by pressing a DSS button. You must press the **TRANSFER** button and dial the destination extension number.

## TRANSFER WITH CAMP-ON

When you are transferring a call to another station and you receive a busy signal, you may camp the call on to this station. Simply hang up when you hear the busy signal. The called party will be alerted that a call is waiting for them.

NOTE: If you receive No More Calls tone, that station has no button available to receive another call. Press **TRANSFER** to return to the outside caller.

## TRANSFER TO VOICEMAIL

This feature is used to send a call directly to a voice mailbox. Your keyset must have a correctly programmed **VT** button to accomplish this. To transfer a call directly to a voice mailbox:

- While on a call, press the **VT** button and dial the mailbox number.
- Hang up when dialing is completed.

## CALL WAITING

If an outside call has been camped-on to your phone or another station has camped-on to you:

- You will hear a tone in the earpiece and the call that is waiting for you (camped-on) will flash. In addition the bottom line of the display will indicate the number of the station or trunk party camped-on.
- Press the flashing button to answer; your other call will go on hold automatically if your station has the Automatic Hold feature set. If not, you must press **HOLD** and then the flashing button **OR**

- Finish the first call and hang up; the waiting call will ring.
- Lift the handset.

NOTE: Intercom calls will not go on Automatic Hold.

## CONFERENCE CALLS

You may conference up to five parties (you and four others) in any combination of outside lines and internal stations in any order.

- While engaged in a conversation, press the **CONF** button and receive conference tone.
- Make another call, either intercom or outside, press the **CONF** button and receive conference tone.
- Make another call or press the **CONF** button to join all parties.
- Repeat the last step until all parties are added.

NOTE: When attempting to add another party to the conference and you are not able to reach the desired person, hang up. Simply press the **CONF** button again to return to your previous conversation.

#### To drop a party from your conference call:

- Press **CONF** and dial the extension or line number that is to be dropped.
- Press **CONF** again to reestablish the conference.

NOTE: To leave the conference, hang up. Control is passed to the next internal station. If there are no internal stations and you wish to leave outside lines connected together in a trunk to trunk conference, press the **CONF** button plus the **CALL** button that the call appears on or follow the instructions to drop a party and use your extension number. When they hang up, the lines will release automatically. Press **CONF** to rejoin a trunk to trunk conference.

#### CONFERENCE SPLITTING

If you are the controlling party of a conference and your keyset has the Auto Hold feature turned on ([See Customizing Your Keyset](#)) and all of the outside lines involved in the conference appear as buttons on your keyset, you can split the conference into separate calls as follows:

- Press any one of the outside line buttons. That outside line will remain steady green to indicate you are still connected to it. All other outside lines in the conference will be placed on system hold at your keyset. All intercom callers in the conference will be disconnected. You may now speak with each caller privately and transfer them as usual or reestablish another conference.

## FORWARDING CALLS

You may forward your calls to another station, group of stations or an external telephone number. Program a destination for the type of forwarding you want as detailed below. If you have **FWD ALL**, **FWD BUSY** and **FWD NO ANSWER** buttons, press one to turn that forward feature on. A steady red light reminds you what forward condition is activated.

You can clear all call forward conditions set at your station by lifting the handset and dialing **600**.

## FORWARD ALL CALLS

To forward all your calls under any condition to another station:

- Dial **601** plus the extension or group number.
- Receive confirmation tone and hang up.

### NOTES:

1. If the Hot Keypad feature has been turned off, you must first lift the handset or press the **SPEAKER** button before you begin dialing.
2. The station that receives a Forwarded All call can transfer the call to the forwarded station. This is useful when you are expecting an important call but you do not wish to be disturbed by other calls.
3. When a station user places his/her keyset in Forward All mode and he/she does not have a **FORWARD ALL** button, the **TRANSFER** button will light to indicate Forward All has been set and calls to this station have been transferred elsewhere.

## FORWARD BUSY

To forward calls to another station when you are on the phone:

- Dial **602** plus the extension or group number.
- Receive confirmation tone and hang up.

NOTE: If the Hot Keypad feature has been turned off, you must first lift the handset or press **SPEAKER** before you begin dialing.

## FORWARD NO ANSWER

To forward calls to another station when you do not answer:

- Dial **603** plus the extension or group number.
- Receive confirmation tone and hang up.

NOTE: If the Hot Keypad feature has been turned off, you must first lift the handset or press the **SPEAKER** button before you begin dialing.

## FORWARD BUSY/NO ANSWER

If you have both a Forward on Busy destination and a Forward No Answer destination programmed, you may set both of these at the same time:

- Dial **604**.
- Receive confirmation tone and hang up.

NOTE: If the Hot Keypad feature has been turned off, you must first lift the handset or press the **SPEAKER** button before you begin dialing.

## FORWARD FOLLOW ME

When you want all calls to your extension forwarded to the extension where you are now:

- Dial **606** plus your extension number.
- Receive confirmation tone and hang up.

If you want a specific extension's calls forwarded to your phone (Remote Call Forward):

- Dial **606** plus the desired extension number.
- Receive confirmation tone and hang up.

NOTE: If the Hot Keypad feature has been turned off, you must first lift the handset or press the **SPEAKER** button before you begin dialing.

## FORWARD DND

To forward your phone when you activate DND.

- Dial **605** plus the extension number or group number.
- Receive confirmation tone and hang up.

NOTE: If the Hot Keypad feature has been turned off you must first lift the handset or press the **SPEAKER** button before you begin dialing.

## CALL FORWARD OPTIONS

A display keyset may review or change call forward options and destinations. Call forward access can be done via the keypad or by accessing the keyset display features. To review or change call forward options:

- Press **TRANSFER 102**.  
The display will indicate the current call forward condition and destination  
**OR**  
Show **0:FORWARD CANCEL** to indicate no forward is set.

- Dial **0** to cancel current condition **OR**  
Dial **1-5** to select the forward type **OR**  
Press **UP** or **DOWN** to select the forward type.  
Press the right soft key to move the cursor.
- Dial the destination number (e.g., **202**) **OR**  
Press **UP** or **DOWN** to select the destination  
Press the right soft key to move the cursor
- Dial **1** to set **OR**  
Press **UP** or **DOWN** to select **YES** or **NO**
- Press **TRANSFER** to store and exit

## STATION CALL PICKUP

To pick up (answer) a call ringing at another station, lift the handset and dial **65** plus the extension number of the ringing phone.

If you have a **DP** key assigned with a station number, you only need to press this **DP** key with the flashing light to answer this ringing station.

NOTE: If the Hot Keypad feature has been turned off, you must first lift the handset or press the **SPEAKER** button before you begin dialing.

## GROUP CALL PICKUP

To pick up (answer) a call ringing in any pickup group, lift the handset and dial **66** plus the desired **group number** or press the flashing **GROUP PICKUP** button if available.

### GROUP NUMBERS

<b>01-10</b>	<b>OfficeServ 7030</b>
<b>01-20</b>	<b>OfficeServ 100, OfficeServ 7100 and OfficeServ 7200-S</b>
<b>01-99</b>	<b>OfficeServ 500 M</b>
<b>01-99</b>	<b>OfficeServ 500 L</b>
<b>01-99</b>	<b>OfficeServ 7200 and OfficeServ 7400</b>

### NOTES:

1. A group pickup button can have an extender for a specific pickup group.
2. If the Hot Keypad feature has been turned off, you must first lift the handset or press the **SPEAKER** button before dialing the access code.

## MY GROUP PICKUP

If desired, a new access code can be assigned to pickup ringing calls in the same pickup group as you are in. Like "66" above except you do not need to dial the desired group number. See your installation company for the assigned access code. MY GROUP PICKUP: \_\_\_\_\_.

## PRIVACY RELEASE

This feature will allow another station to join in our conversation by releasing privacy on the C.O. from your phone.

### To Release Privacy:

While you are talking on a C.O. line and you wish to have other internal parties (or up to three) join the conversation.

- Press the **PRB** button (the **PRB** button will light steady red). Inform the other party that he/she may now join the conversation.

After the other party (or parties) has joined the conversation and you wish to return privacy to the line so that no one else can join the conversation, press the **PRB** button a second time, the **PRB** button will be off.

### To Join a Non-Private Conversation:

When someone has informed you that you can join a conversation:

- Press the **C.O. line** button that he/she has indicated.  
OR
- Dial the **C.O. line number** that he/she has indicated.

# DIALING FEATURES

## SPEED DIALING

You can dial a preprogrammed telephone number stored in the system-wide speed dial list of numbers 500~999 or from your personal list of numbers 00~49.

Your system may be set for 950 system wide numbers. If so the system speed dial access codes are 050~999 and the station speed dial codes are 000~049.

- With the handset on-hook, press the **MEMORY** button or dial **16**.
- Dial the desired speed dial number.
- The telephone number is automatically dialed for you.

NOTE: If the Hot Keypad feature has been turned off, you must first lift the handset or press the **SPEAKER** button before you begin dialing.

## PROGRAMMING PERSONAL SPEED DIAL NUMBERS

You can program frequently dialed telephone numbers in a personal speed dial list. A station may be assigned up to fifty numbers, **00–49**. See your system administrator to determine the amount assigned to your station.

- While on-hook, press **TRANSFER** and then dial **105**.
- Dial a speed dial number (**00–49**).
- Dial a line or line group access code.
- Dial the telephone number to be stored (24 digits maximum). It can include #, \*, FLASH and PAUSE.
- Press **TRANSFER** to store the number.

NOTE: If the Hot Keypad feature has been turned off, you must first lift the handset or press the **SPEAKER** button before you begin dialing.

For the purposes of programming speed dial numbers, the programmable buttons are known as **A, B, C, D, E** and **F**.

- The **A** button is not used.
- The **B** button inserts a flash.
- The **C** button inserts a pause.
- The **D** button is used for pulse to tone conversion. If your system uses rotary (or pulse) dialing C.O. lines, pressing **D** while entering a speed dial number causes all subsequent digits to be sent as DTMF tones.
- The **E** button is used to hide digits. Display keyset users may want to hide some speed dial numbers so that they will not show in the display. When you are entering a telephone number, press **E**. All subsequent digits will be hidden. Press **E** again to begin displaying digits.
- The **F** button is used to enter a name. [See \*Personal Speed Dial Names under Display Features.\*](#)
- Use the **HOLD** button to clear a speed dial number.

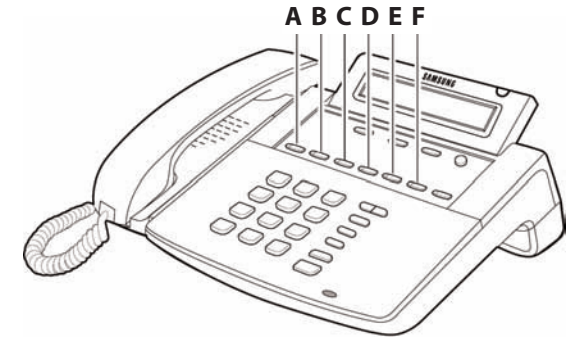

## ONE TOUCH SPEED DIALING

You may assign any speed dial number to an already existing One Touch Speed Dial button for quick and easy dialing of frequently used numbers.

- While on-hook, press **TRANSFER** and then dial **107**.
- Press a One Touch Speed Dial button.
- Dial the speed dial number (**00–49** or **500–999**) that you want assigned to this button.
- Press **TRANSFER** to store your selection.

To call this telephone number, just press the One Touch Speed Dial button.

NOTE: If the Hot Keypad feature has been turned off, you must first lift the handset or press the **SPEAKER** button before you begin dialing.

## LAST NUMBER REDIAL

To redial the last telephone number you dialed, press the **REDIAL** button or dial **19**.

NOTES:

1. If the Hot Keypad feature has been turned off, you must first lift the handset or press the **SPEAKER** button before you begin dialing.
2. Redial does not apply to intercom calls.



## MANUAL RETRY WITH REDIAL

While you are on an outside call listening to a busy signal and you want to redial the same number dialed.

- Press the **REDIAL** button.

This will hang up your existing call and manually redial the same number dialed. You can repeat this operation for a limited number of attempts.

NOTE: If your keyset is programmed with Call Log Blocks then the Redial will access the call log when pressed.

## SAVE NUMBER WITH REDIAL

To save the number you just dialed for later use, press the **SNR** button before hanging up.

To redial this saved number at any time, press the **SNR** button or dial **17**. The same line will be selected for you.

NOTES:

1. If the Hot Keypad feature has been turned off, you must first lift the handset or press the **SPEAKER** button before you begin dialing.
2. The saved telephone number is stored in memory until you save another number.
3. Redial does not apply to intercom calls.

## CHAIN DIALING

You may manually dial additional digits following a speed dial number or chain as many speed dial numbers together as required:

- After the first speed number is dialed, press **MEMORY** again and dial another speed number **OR** manually dial additional digits following a speed dial number.

## AUTOMATIC REDIAL/RETRY

When you are making an outside call and you receive a busy signal, the system can automatically redial the number for you. It will automatically redial at a pre-programmed interval for up to 15 attempts.

- When you hear a busy signal, press the **RETRY** button.
- The system will reserve the line and automatically redial the same number for you. You will hear the call being made through the keyset speaker. The microphone is muted.

- When the called party answers, lift the handset or press the flashing **SPEAKER** to begin speaking.

NOTES:

1. If you make another call, auto-redial is canceled.
2. To cancel a retry, lift and replace the handset.

## PULSE TO TONE CHANGEOVER

When making an outside call on a dial pulse line, press **#**. All digits dialed after the **#** will be sent as tones.

## MEMO REDIALING

When you are calling directory information, you can store the number you are given using the **SAVE** feature. There is no need for pencil and paper.

- While you are talking on an outside call, press **SAVE**.
- Dial the telephone number as it is dictated to you on the keypad.
- Press **SAVE** to store the number.

To dial the number, press the **SNR** button. It will select the same line and dial the stored number. If necessary, you can select a different line and then press the **SNR** button.

# PAGING AND MESSAGING

## MAKING AN INTERNAL PAGE

To make an announcement through the keyset speakers in the idle condition:

- Lift the handset.
- Press the **PAGE** button or dial **55**.
- Dial the desired zone number **0, 1, 2, 3** or **4**.
- After the attention tone, make your announcement.

### NOTES:

1. If you have a dedicated page zone button, it is not necessary to press **PAGE** and dial a zone number.
2. If allowed by your system administrator you may be able to initiate a page from a speakerphone by pressing the **PAGE** key or dialing **55** without lifting the handset.

## MAKING AN EXTERNAL PAGE

To make an announcement through the external paging speakers:

- Lift the handset.
  - Press the **PAGE** button or dial **55**.
  - Dial the desired zone number **5, 6, 7** or **8**.
- OR**
- Dial **9** to page all external zones.
  - After the attention tone, make your announcement.

### NOTES:

1. If you have a dedicated page zone button, it is not necessary to press **PAGE** and dial a zone number.
2. If allowed by your system administrator you may be able to initiate a page from a speakerphone by pressing the **PAGE** key or dialing **55** without lifting the handset.

## ALL PAGE

To page all designated keysets in internal zone 0 and all external zones at the same time:

- Lift the handset.
- Press the **PAGE** button or dial **55**.
- Dial **\*** or press the **ALL PAGE** button.
- After the attention tone, make your announcement.

### NOTES:

1. The LED on the **PAGE** button will only light when an All Page is in progress.
2. If allowed by your system administrator you may be able to initiate a page from a speakerphone by pressing the **PAGE** key or dialing **55** without lifting the handset.

## MEET ME PAGE

- Lift the handset.
- Press the Meet Me Page (**MMPG**) button or dial **54**.
- Dial the desired zone number.
- After the attention tone, instruct the paged person to dial **56**.
- Press **WAIT** or **TRANSFER**.
- Remain off-hook until the person dials **56** from any phone.
- The paged person will be automatically connected with you.

## CALL PARK AND PAGE

When you have an outside call for someone who is not at his/her desk, you can park the call prior to paging. There are two different methods:

### MANUAL PARK ORBITS

- While in conversation, press the **PARK** button.
- Entered a desired orbit number (**0-9**), if the orbit number is busy dial another orbit number. Display users can press **\*** to automatically place the call in any available orbit number and see the number in the display.
- Remember the selected orbit number.
- Replace the handset when finished.
- Lift the handset and make a page announcement as previously described (example: "John Smith park two").

### To retrieve a parked call from orbit:

- Press the **PARK** button and dial the announced orbit number (**0-9**).
- You will be connected to the parked call.

### NOTES:

1. You must have a **PARK** button or park access code to retrieve and place calls in park orbits.
2. If the parked call is not retrieved within a pre-programmed period of time, it will recall your keyset and have a slow flashing amber light. You cannot park and page intercom calls.
3. If the Hot Keypad feature has been turned off, you must first lift the handset or press the **SPEAKER** button before you begin dialing.

## AUTOMATIC PARK WITH PAGE BUTTON

- While in conversation, press the **PAGE** button. The call is automatically parked at your station.
- Receive page tone and dial a desired page zone number.
- Make announcement indicating your extension number or the line number. Hang up.

### To retrieve an automatically parked call:

- Dial **10** plus the number that was announced. If you have a **PAGPK** button, press it and dial the number that was announced. If you have a **PARK** button, press it and dial the announced orbit number.
- You will be connected to the parked call.

### NOTES:

1. If the call is not retrieved within a pre-programmed period of time, it will recall your keyset and have a slow flashing amber light. You cannot park and page intercom calls.
2. If the Hot Keypad feature has been turned off, you must first lift the handset or press the **SPEAKER** button before you begin dialing.

## SETTING A MESSAGE INDICATION

When you are calling another station and no one answers or you receive a busy signal, you can leave a message indication:

- Press the **MESSAGE** button or dial **43** and receive confirmation tone.
- Hang up. The **MESSAGE** button on the called station will light. Standard telephones receive special dial tone as a message indication or a lit message lamp, if the phone is equipped with one and they are connected to an 8MWSLI card (not available on the OfficeServ 100 or OfficeServ 7000 Series) or a 16MWSLI card on the system.

### NOTES:

1. A station can have up to five message indications.
2. If the Hot Keypad feature has been turned off, you must first lift the handset or press the **SPEAKER** button before you begin dialing.

## CANCELING MESSAGES

To cancel a message indication that you left at another station, dial **42** plus the extension number of the station at which you left a message. To cancel all message indications left at your keyset, dial **42** plus your extension. Your **MESSAGE** light will go out.

NOTE: If the Hot Keypad feature has been turned off, you must first lift the handset or press the **SPEAKER** button before you begin dialing.

## RETURNING MESSAGES

- Press the **MESSAGE** button or dial **43**. The first station that left a message will be called automatically. If that station does not answer, your **MESSAGE** light will stay on.
- Repeat until all messages have been returned in the order received.
- Your **MESSAGE** light will turn off when all messages have been returned.

### NOTES:

1. Display keyset users can view message indications and return them in any order. [See Viewing Message Indications under Display Features.](#)
2. If the Hot Keypad feature has been turned off, you must first lift the handset or press the **SPEAKER** button before you begin dialing.
3. If a message has been left at your keyset by a keyset in Auto Answer, you must manually cancel the message after it has been returned.

## PROGRAMMED MESSAGES

When you will be away from your phone for any length of time, you can leave a programmed station message. Display stations calling you will see this message and be informed of your status or follow your instructions.

- Dial **48** plus any of the message codes (**01–20**) listed on the back of this user guide.
- To cancel any of these messages you might have selected, dial **48** plus **00**.
- Press **TRANSFER** to exit and store your selection.

NOTE: If the Hot Keypad feature has been turned off, you must first lift the handset or press the **SPEAKER** button.

You can have multiple programmed message buttons (**PMSG**) and each one can have a different message code:

- Press any programmed message (**PMSG**) button. The message is set and the button will light red. Press the button again to turn off.
- Pressing another programmed message (**PMSG**) button will turn the previous one off and set a different programmed message.

# CONVENIENCE FEATURES

## LOGGING IN AND OUT

If enabled, your ITP-5107S telephone may require you to log in before making or receiving calls. In these cases your telephone system administrator will provide you with an extension number, password, and the feature code used to log out.

### To log in:

- Press **ENTER** to begin login.
- Dial your extension number.
- Press **ENTER**.
- Dial your password.
- Press **ENTER** twice.

### To log out:

- Dial the feature code provided by your administrator (for example 77).

## DO NOT DISTURB

Use this feature when you want to block calls to your keyset.

- While on-hook, press the **DND** button or dial **401**. The **DND** button lights steady red to remind you of this mode.
- To cancel DND, press the **DND** button again or dial **400**. The **DND** light turns off. You can make calls while in the DND mode.

### NOTES:

1. If the Hot Keypad feature has been turned off, you must first lift the handset or press the **SPEAKER** button.
2. If you place your keyset in DND mode and you do not have a **DND** button, your **TSI** button will flash to indicate DND status.

## ONE TIME DND

If you are on a call and you do not wish to be interrupted while on that call, you can press the **DND** button and place your station in Do Not Disturb. When you hang up at the end of the call, DND will be automatically canceled and your keyset will be able to receive new calls. This feature requires a **DND** button.

## MUTE

You can mute the handset transmitter or the microphone during any conversation:

- Press the **MUTE** button. It will light red.
- To resume speaking, press the **MUTE** button again. The light turns off.

## BACKGROUND MUSIC

When a music source is supplied, you may listen to music through the speaker in your keyset:

- While on-hook, press the **HOLD** button to hear music.
- Press the **HOLD** button again to turn music off.

You can set the level of background music by using the **VOLUME** buttons while listening to the music. This does not affect the speakerphone level.

## ESTABLISHED CALL PICKUP

To pick up an established call in progress at a single line extension connected to a computer modem on your PC.

- Press the **EP** button for that station on your keyset and the call is automatically moved to your keyset.
- The single line extension on your modem will be disconnected.

NOTE: You must have an assigned (EP button) button on your regular keyset, for the single line station.

## APPOINTMENT REMINDER/ALARM CLOCK

This feature works like an alarm clock. Use it to remind yourself of an appointment later in the day (TODAY ONLY) or as a daily reminder every day (DAILY). You can set up to three alarms. Each one can be either a TODAY ONLY or a DAILY alarm.

When the alarm rings, you will hear three short rings repeated three times. Lift the handset to answer the alarm. If you do not, the alarm will alert you two more times at five minute intervals.

To set alarms:

- Press **TRANSFER** and then dial **112**.
- Dial the alarm number **1**, **2** or **3**.
- Dial the time at which you want the alarm to sound. Enter the time as HHMM (hours and minutes) using the 24 hour clock.
- Dial **0** (NOT SET), **1** (TODAY ONLY) or **2** (DAILY) to select the alarm type.

- Press **TRANSFER** to save.
- Repeat for each alarm if needed.

To cancel individual alarms:

- Press **TRANSFER** and then dial **112**.
- Dial alarm number **1, 2 or 3**.
- Press the **HOLD** button.

NOTE: Display keysets can show a reminder message. [See Alarm Reminder Messages under Display Features.](#)

## ANSWERING THE DOOR PHONE

When you are programmed to receive calls from a door phone:

- You will receive three short rings repeated.
- Lift the handset. You are connected to the door phone.
- If an electric door lock release is installed, dial **13** to unlock the door.

## CALLING THE DOOR PHONE/ ROOM MONITOR

You may call the door phone and listen to what may be happening outside or in another room.

- Dial the extension number of the door phone.
- You will be connected to the door phone and you can listen or have a conversation.
- If an electric door lock release is installed, dial **13** to unlock the door.

NOTE: If the Hot Keypad feature has been turned off, you must first lift the handset or press the **SPEAKER** button.

## EXECUTIVE/SECRETARY HOT LINE

If programmed, an executive and a secretary can have a hot line between them. When the executive station is in the DND mode, all of its calls will ring the secretary station. If the secretary does not answer, the caller will go to the secretary's voice mail box if setup.

- Either person can press the **BOSS** button to make a voice call to the other station.
- Using the hot line will override DND at the other station. This button will light red when the other station is in use.

### To transfer a call to a Boss in DND:

- Press the **TRANSFER** button followed by the **BOSS** button.
- Wait for the **BOSS** to answer, then announce the call and hang up to complete the transfer **OR**
- Hang up to complete a blind transfer after pressing the **BOSS** button.

## EXECUTIVE DIVERT

When the executive station is in DIVERT mode all of his/her calls will ring the secretary station.

- Press the **DIVERT** key to pass a call while ringing.

### To transfer all calls to the Secretary:

- Press the **DIVERT** button while the phone is idle. The LED will be lit and all calls will ring the secretary.

The secretary can call the BOSS in the DIVERT mode but all other users will ring the secretary (the secretary can override the boss' DIVERT).

## GROUP LISTENING

When you are engaged on a call and you are using the handset, you may want other people to hear the distant party's voice over the speaker:

- Press the **LISTEN** button to turn on the speaker. The microphone is not in use, so the distant party does not hear other parties present in your office.
- Press **LISTEN** again to turn the speaker off and resume private conversation.
- Repeat if necessary.

NOTE: Depending on speaker volume and the acoustics of your office, it may be advisable to turn the group listening feature off before hanging up. This will eliminate a momentary squeal.

## ACCOUNT CODES

When enabled, your system allows calls to be charged to different accounts. You can enter account codes either by dialing the full code, by entering an account code "bin number", or by pressing your **ACC** key if one is assigned. Bin numbers are a 3 digit short code that will automatically insert the appropriate account code. Account codes may be a maximum of 12 digits (# may be used); if the account code is to be less than 12 characters you may end the code by pressing **\*** or the right soft key. The type of code used is determined by your telephone system administrator. Codes can be entered before or during a call as follows:

### To enter an account code before placing the call:

- Press your **ACC** key or dial **47**.
- Dial the account code or bin number.
- You will receive a confirmation tone and display.
- When prompted dial a trunk or trunk group (i.e. 9) and the telephone number to call.

### To enter an account code by interrupting the conversation:

- While on an outside call press the **ACC** key or press **TRANSFER** followed by **47**.
- Dial the account number or bin number (if you are entering an account code you will need to press your **ACC** key or right soft key to finalize the entry)

NOTE: If you make an error simply repeat the procedure with the correct code. Only the most recent account code dialed will be recorded.

## LOCKING YOUR KEYSSET

You can lock your keyset to control misuse of your phone while you are away. You can unlock it when you return. Your default station passcode is 1234.

	0 UNLOCKED	1 LOCKED OUTGOING Hold Button LED Flashes	2 LOCKED ALL CALLS Hold Button LED Solid
Make outside calls	YES	NO (ACCESS DENIED)	NO
Receive outside calls	YES	YES	NO
Make intercom calls	YES	YES	NO
Receive intercom calls	YES	YES	NO
Make 911 calls	YES	YES*	NO

- While on-hook, press **TRANSFER** and then dial **100**.
- Dial your four digit station passcode.
- Dial **1** to locking outgoing, **2** for locked all calls, or **0** to unlock.
- Press **TRANSFER** to store your selection.

Note\*: When 911 is programmed, 911 emergency dialing is allowed for a LOCKED OUTGOING station.

## MANUAL SIGNALLING

Use this feature when you want to send a brief 500ms ring burst to another station, regardless of the status of your phone (on-hook, off-hook, handsfree, DND, or ringing).

### To send a signal to another station:

- Press the Manual Signalling (**MS**) button.
- You may press the **MS** button repeatedly to send multiple signals to the designated station.

**NOTE: Your phone must have a Manual Signalling (MS) button with a station number extender assigned to it.**

## OFF-HOOK VOICE ANNOUNCE

Keysets may receive a voice announcement while on another call. The calling station must have an **OHVA** button. When you are in DND, you cannot receive OHVA calls. The OHVA feature will work with intercom and transferred calls.

When you receive an OHVA and secure OHVA is ON, you will hear the announcement in the handset receiver, if you are using the handset. If secure OHVA is OFF then you will hear the announcement on the speaker, if you are talking on the handset. If you are using the speakerphone the announcement will always be heard through the speaker.

### To make an off-hook voice announcement:

- Dial the extension number or press the **DSS** button.
- When you receive a busy signal, press the **OHVA** button.
- After the attention tone, begin speaking.
- Finish the call by replacing the handset.
- Press the flashing **CALL** button on your keyset. This will place the original party on hold and allow you to talk to the announcing party.
- To return to your first party, press the button corresponding to your original call. This will disconnect the OHVA call.

### NOTES:

1. When you are voice announcing to a station close to you, use the handset to avoid an echo effect.
2. You cannot off-hook voice announce to single line telephones.

## OHVA BLOCK

Your keyset can be programmed with an OHVA Block (**BLOCK**) button. Pressing this button will prevent anyone from making an OHVA to you until you press the button again and cancel the blocking.

## OHVA REJECT

Your keyset can be programmed with an OHVA Reject (**REJECT**) button. Pressing this button while receiving an OHVA call will disconnect the voice announcing party and return you to your original call.

## IN GROUP/OUT OF GROUP

If your keyset is assigned to a station ring group, you can remove your keyset from the group and then put it back in. While you are out of the group, you can receive calls to your extension number but not calls to the group number. If you have an **IN/OUT** button with the group number assigned.

- Press the **IN/OUT** button. It will light red when your keyset is in the group.
- Press the **IN/OUT** button again to exit the group and turn the light off. Repeat as necessary.

If you do not have an **IN/OUT** button:

- Dial the **IN/OUT** access code number \_\_\_\_\_, then the group number, then **0** to exit the group or **1** to enter the group.

NOTE: If the Hot Keypad feature has been turned off, you must first lift the handset or press **SPEAKER** button.

The **IN/OUT** button can include an extender to indicate the specific group that this button will affect. This means that if you are in multiple groups, you can decide for which groups you will receive calls.

## CUSTOMIZING YOUR KEYSSET

### AME PASSWORD

This feature allows customers using the AME feature to enable password protection. This will prevent unauthorized users from listening to your messages being left. The passcode is the same as your station passcode. This feature only applies if there is an Samsung Voicemail card installed in the system and your keyset has a programmed AME button.

- With the handset on-hook, press **TRANSFER** and then dial **110**.
- Dial **101** to turn on AME PASSCODE or **100** to turn it off.
- Press **TRANSFER** to store your selection.

### AUTO CAMP-ON

This option allows intercom calls to be automatically camped on, if possible, when a busy station is called.

- With the handset on-hook, press **TRANSFER** and then dial **110**.
- Press **081** to turn CAMP-ON on or **080** to turn it off.
- Press **TRANSFER** to store your selection.

### SELECT RING TONE

Each keyset user can select any one of eight ring frequencies:

- While on-hook, press **TRANSFER** and then dial **111**.
- Dial **1-8** or press the **UP** and **DOWN** buttons to hear each tone.
- When you hear the tone that you prefer, press **TRANSFER** to save it.

**NOTE: Specific lines or stations may be programmed to ring with a different tone than what you have selected for your keyset.**

### CHANGE YOUR PASSCODE

From the factory, your station passcode is 1234. You can change your station passcode whenever you desire.

- While on-hook, press **TRANSFER** and then dial **101**.
- Dial your old passcode.
- Dial a new passcode (must be four characters). You can use **0-9**.
- Redial the new passcode to verify. If successful, you will hear two beeps. Four beeps indicate an incorrect code. Reenter the code again.
- Press **TRANSFER** to store the new passcode.

## SET ANSWER MODE (INTERCOM)

You can receive internal calls in one of three modes ([see Answering Intercom Calls under Intercom Calls for descriptions](#)):

- While on-hook, press **TRANSFER** and then dial **103**.
- Dial **0** for Ringing, **1** for Auto Answer or **2** for Voice Announce.
- Press **TRANSFER** to store your selection.

## SET ANSWER MODE (CO)

Your incoming CO calls can be set to follow the intercom answer mode.

- While on-hook, press **TRANSFER** and then dial **110**
- Dial **15** to access **AUTO ANS CO**.
- Press the **VOLUME UP** or **DOWN** key to change status.
- Press **TRANSFER** to store your selection.

## AUTOMATIC HOLD

While on an outside call, pressing a line button, route button or a flashing **CALL** button will automatically put your call on hold and connect you to the next call. This feature can be turned on or off at your keyset.

- With the handset on-hook, press **TRANSFER** and then dial **110**.
- Dial **001** to turn Automatic Hold on or **000** to turn it off.
- Press **TRANSFER** to store your selection.

NOTE: Intercom calls can be automatically put on hold by pressing **TRANSFER**.

## HEADSET OPERATION

Keyset users can switch between headset mode and handset mode. When using headset mode, press the **FLASHING CALL** button to answer and release calls.

- With the handset on-hook, press **TRANSFER** and then dial **110**.
- Dial **021** to use the headset or **020** to use the handset.
- Press **TRANSFER** to store your selection.

Your keyset may be equipped with a Headset mode button. If it is so equipped pressing this button while the light is out will cause the keyset to enter headset mode and the light will illuminate to indicate this. Pressing the button while the light is lit will cause the keyset to return to handset mode and the light will go out.

## HOT KEYPAD

On your phone system your keyset's keypad can be made "live" or "hot" so that it is not necessary to lift the handset or press the **SPEAKER** button before you begin dialing. Calls can be made and features activated by simply dialing the C.O. line number, trunk group access code, intercom number or feature access code. To activate this feature:

- With the handset on-hook, press **TRANSFER** and then dial **110**.
- Dial **031** to turn the Hot Keypad on or **030** to turn it off.
- Press **TRANSFER** to store your selection.

## KEY CONFIRMATION TONE

You can hear a short beep (confirmation tone) each time you press a button on the dial pad. This tone can be turned on or off.

- While on-hook, press **TRANSFER** and then dial **110**.
- Dial **040** to turn tones off or **041** to turn tones on.
- Press **TRANSFER** to store your selection.

## REJOINING A PAGE

This feature allows you to hear the remaining portion of an ongoing internal page after you return your keyset to idle. To enable this feature:

- With the handset on-hook, press **TRANSFER** and then dial **110**.
- Dial **051** to turn this feature on or **050** to turn it off.
- Press **TRANSFER** to store your selection.

## RING PREFERENCE

This feature automatically answers ringing calls when you lift the handset. This method will always answer calls in the order they arrived at your keyset. When you turn ring preference off, you must press the flashing button to answer a call, allowing you to answer calls in the order you choose.

- With the handset on-hook, press **TRANSFER** and then dial **110**.
- Dial **061** to turn ring preference on or **060** to turn it off.
- Press **TRANSFER** to store your selection.

## AUTO ANSWER CO CALLS

This option will allow CO calls that directly ring your phone to auto answer. When a CO call arrives at your station and this option set for ON your phone will sound two beeps, the same as when a screened transfer is completed, and you will be



connected to the CO call. In order for this option to work the station must also be programmed for auto answer ([see SET ANSWER MODE](#)).

- While on hook, press **TRANSFER** and then dial **110**.
- Dial **151** to turn Auto Answer CO on or **150** to turn it off.
- Press **TRANSFER** to store your selection.

NOTE: Outside lines must ring your station directly for the Auto Answer CO to work. Lines ringing a station group will not cause your phone to Auto Answer.

## DISPLAY SPEED DIAL NAME

This option allows you to view the name associated with a speed dial number as it is dialed.

- With you handset on-hook, press **TRANSFER** and then dial **110**.
- Press **111** to turn **DISP SPDNAME** on or **110** to turn it off.
- Press **TRANSFER** to store your selection.

## CALLER ID REVIEW ALL

This feature allows display keyset users to review Caller ID information for calls sent to their stations. This list can be from ten to fifty calls in a first in, first out basis. The list includes calls that you answered and calls that rang your station but that you did not answer. When reviewing this list, you can press one button to dial the person back. The system must be using LCR to dial the stored number.

- With you handset on-hook, press **TRANSFER** and then dial **110**.
- Press **121** to turn **CID REVIEW ALL** on or **120** to turn it off.
- Press **TRANSFER** to store your selection.

## SECURE OHVA

This option allows you to receive OHVA calls via the speaker while you are on the handset.

- With you handset on-hook, press **TRANSFER** and then dial **110**.
- Press **131** to turn **AUTO CAMP-ON** on or **130** to turn it off.
- Press **TRANSFER** to store your selection.

## CONFIGURE MOBILE EXTENSIONS (MOBEX)

This feature allows you to configure options for any Mobile Extension (MOBEX) ports that are assigned to you by your telephone system administrator. You can turn a port on or off; set the telephone number for the port; or set the caller ID you will be calling in from. The caller ID field has no effect unless you have been authorized as an Executive MOBEX user. Check with your telephone system administrator for further details on your specific system configuration.

### To set the phone number a MOBEX port can reach you on:

- Press **TRANSFER** and then dial **126**.
- Dial your station pass code.
- Dial the number of the port you wish to configure (1-5) (you may also use the Volume Up and Volume Down keys to select a port and press the right soft key to confirm).
- Dial **0** to select the telephone option.
- Dial the number of a C.O. line to use when making calls to this MOBEX port.
- Dial the phone number you can be reached at by users calling this MOBEX port.
- Press **TRANSFER** to store your selection and exit programming.

### To set the caller ID of the location you will be calling in from:

- Press **TRANSFER** and then dial **126**.
- Dial your station pass code.
- Dial the number of the port you wish to configure (1-5) (you may also use the Volume Up and Volume Down keys to select a port and press the right soft key to confirm).
- Dial **1** to select the caller ID option.
- Dial the phone number you will be calling in from.
- Press **TRANSFER** to store your selection and exit programming.

### To turn a MOBEX port ON or OFF:

- Press **TRANSFER** and then dial **126**.
- Dial your station pass code.
- Dial the number of the port you wish to configure (1-5) (you may also use the Volume Up and Volume Down keys to select a port and press the right soft key to confirm).
- Dial **2** to select the activation status option.
- Dial **0** to turn the port on, dial **1** to turn the port off.
- Press **TRANSFER** to store your selection and exit programming. To turn a MOBEX port ON or OFF:
- Press **TRANSFER** and then dial **126**.

- Dial your station pass code.
- Dial the number of the port you wish to configure (1-5) (you may also use the Volume Up and Volume Down keys to select a port and press the right soft key to confirm).
- Dial **2** to select the activation status option.
- Dial **0** to turn the port on, dial **1** to turn the port off.
- Press **TRANSFER** to store your selection and exit programming.

## DISPLAY FEATURES

### INTERACTIVE DISPLAY KEYS

The three keys below the display are substitutes for dedicated feature keys and access codes. Pressing one of these buttons has the same effect as pressing a programmable button. These buttons are called soft keys as their functions are not fixed. They change to present you with the best options for that call condition. The use of soft keys allows the programmable buttons to be used for more **DSS** and speed dial buttons.

The **SCROLL** button is used to display options available to the user at a particular time or during a specific procedure. Press this button once while in the idle state to view the three main categories available.

201:STN NAME  
CALL OTHER ANS

**ANSWER:** Guides you through the options to answer calls.

**OTHER:** Guides you through features other than making or answering calls.

**CALL:** Guides you through the options to make a call.

Select one of the main categories: **CALL**, **OTHER** or **ANS (ANSWER)**. Press the **SCROLL** button to display additional options available under each of the three main categories. The symbol ➡ displayed as the last character on the lower line of the display indicates that there are additional options. Press the **SCROLL** button to display these additional options.

User instructions will be displayed in lower case letters. Options assigned to soft keys will be in upper case letters.

### DIRECTORY INFORMATION

An 11 character directory name can be assigned to each extension number. Display keyset users can view the name of the called or calling station before answering.

Each outside line can have an 11 character directory name. Incoming calls can be easily identified and answered with different greetings.

Outside and internal calls ringing to a station group will display [CALL FOR xxx] where xxx is the station group number. This allows you to answer calls directed to you differently than calls directed to your group.

## CALL LOG

The system can log both incoming and outgoing calls placed from or to your telephone. You must have a **LOG** button programmed on your keyset and assigned a review list.

Each **IN** and **OUT** list can be up to 50 numbers maximum. They are assigned in blocks of 10 each.

- Press the **LOG** key.
- Press either the **IN** or **OUT** key.
- View the first IN/OUT telephone number. At this point you may select one of the three options related to this number or use the **UP/DOWN** keys to scroll through your list of calls.
- Press the **CLEAR** button to erase this number from the list.
- Press the **NND** key repeatedly to view the Name, Number, or Date associated with this call.
- Press the **DIAL** key to call this number.

These options are the same for the incoming or outgoing call logs.

## DIAL BY NAME

Each station or speed dial number can have an associated directory name. A station or speed dial number can be selected by scrolling alphabetically through a directory name list. This on-line “phone book” allows the user to look up and dial any station or speed dial number in seconds.

- Press the **DIR** button (**DIRECTORY**).
- Select the directory you wish to use: **PERS** (personal speed dial numbers), **SYS** (system speed dial numbers) or **STN** (station names).
- Dial the key on the keypad that corresponds to the first letter of the name you wish to search for.
- Use the **UP** and **DOWN** arrows to scroll through the names.
- Press the **DIAL** soft key to dial the number.

NOTE: A **DIR** button can have an extender to take you directly to one of the above lists (PERS, SYS, or STN).

## CALL PROGRESS DISPLAYS

During everyday call handling, your keyset display will provide information that is helpful and in some cases invaluable. Displays like [CALL FROM 203], [TRANSFER TO 202], [701: RINGING], [TRANSFER FM 203], [708 busy], [Camp on to 204], [Recall from 204], [Call for 501], [message frm 204] and [FWD ALL to 204] keep you informed of what is happening and where you are. In some conditions you are prompted to take an action and in other cases you receive directory information.

## DISPLAY NUMBER DIALED

Display keysets begin showing digits as they are dialed. They will stay in the display until the call duration timer comes on automatically or the **TIMER** button is pressed. If the call duration timer is not used, the number dialed will be displayed until the call is released, transferred or put on hold.

## CALL DURATION TIMER

The system can be set to automatically time outside calls. A few seconds after you dial a telephone number, the timer appears in the display. It appears immediately for incoming calls. The call timer continues for the duration of the call. Call duration times are displayed in minutes and seconds. If a call lasts longer than 60 minutes, the timer restarts.

You can press the **TIMER** button to manually begin timing a call. Press it again to stop timing. If you press it while the automatic timer is on, the call duration time is restarted.

## AUTO TIMER

Display keyset users may have the timer automatically start when they answer incoming calls or after a short delay on an outgoing call.

- With the handset on-hook, press **TRANSFER** and then dial **119**.
- Dial **41** to turn the auto timer on or **40** to turn it off.
- Press **TRANSFER** to store your selection.

## TIMER FUNCTION

Display keyset users may use this feature as a simple stopwatch.

- When the keyset is idle, press the **TIMER** button to start timing.
- Press the **TIMER** button again to stop timing.
- Read the elapsed time in the display.
- Lift the handset and replace it. The display will return to date and time.

## VIEWING MESSAGE INDICATIONS

You can view all of your message indications before you return them:

- With the handset on-hook, press the **MESSAGE** button with the red flashing light.
- The first station that left a message indication will be displayed.
- Press the **UP** and **DOWN** arrows to scroll through the stations that left message indications. Use the soft keys to reply, clear or advance to the next message.

## ALARM REMINDER MESSAGES

*(See also Special Application Menu-Name Search)*

When you use the alarm/appointment reminder feature, you create a 16 character reminder message. When the alarm rings, your message will appear instead of [ALARM REMINDER]. To program reminder messages:

- Press **TRANSFER** and then dial **116**.
- Dial the alarm number **1, 2** or **3**.
- Dial the time you want the alarm to go off. Enter the time as HHMM (hours and minutes) using the 24 hour clock.
- Dial **0** (NOT SET), **1** (TODAY) or **2** (DAILY) to select the alarm type.
- Write your message using the dial pad keys. Each press of a key selects a character. Pressing the next key moves the cursor to the next position. For example, if your message is "TAKE MEDICATION," press **8** once to get the letter "T." Press **2** once to get "A." Press **5** twice to get "K." Continue selecting characters from the following table to complete your message.
- Press the **TRANSFER** button to store the alarm and reminder message.
- Repeat for each alarm if needed.

COUNT	1	2	3	4	5
DIAL 0	<	>	.	)	0
DIAL 1	space	?	,	!	1
DIAL 2	A	B	C	@	2
DIAL 3	D	E	F	#	3
DIAL 4	G	H	I	\$	4
DIAL 5	J	K	L	%	5
DIAL 6	M	N	O	^	6

DIAL 7	P	Q	R	S	7
DIAL 8	T	U	V	Q	8
DIAL 9	W	X	Y	Z	9
DIAL *	:	=	[	]	*

NOTES:

1. When the character you want appears on the same dial pad key as the previous character, press **UP** to move the cursor one space to the right.
2. Other symbols are available for DIAL #.

To cancel an individual alarm and reminder message:

- Press **TRANSFER** and then dial **112**.
- Dial alarm number **1, 2** or **3**.
- Press the **HOLD** button.
- Press the **TRANSFER** button.

## PERSONAL SPEED DIAL NAMES

Each personal speed dial number can have an 11 character name assigned to it. This name is used to select the speed dial bin when you are dialing by directory.

- Press **TRANSFER** and then dial **106**.
- Dial the speed dial bin number **00-49**.
- Write your message using the procedure described in *Alarm Reminder Messages*.
- Press the **TRANSFER** button to store the speed dial name.
- Repeat for each speed dial bin if necessary.

## STATION NAMES

You can assign an 11 character name to your keyset. This allows other display keyset users to call you using the directory dial feature.

To program a station name:

- Press **TRANSFER** and then dial **104**.
- Enter the 11 character name using the procedure described in [Alarm Reminder Messages](#).
- Press **TRANSFER** to store the name.

## MANAGING KEY ASSIGNMENTS

You can view your key assignments and add extenders to some of your programmable keys for easy one touch operation of frequently used features.

- While on-hook, press **TRANSFER** and then dial **107**.
- Use the **VOLUME** buttons to scroll through all of your programmable buttons **OR** press the programmable button to which you want to add the extender.
- When you reach a key listed below, dial the corresponding extender.
- Press **TRANSFER** to store and exit programming.

Please refer to the [Enhanced Display Programming Section](#) provided by your installation company when requested for a complete list of descriptions and extenders for any keys you may have programmed on your keyset.

NOTE: Confirm that the cursor is placed correctly before you enter the extender.

## LCR WITH CLEAR

When you are making an outside call using LCR and dial an incorrect digit, you can press the **CLEAR** soft key to reenter the telephone number. You do not need to redial **9** to reaccess LCR.

## BACKSPACE WITH LCR

If you misdial while using LCR, you can delete digits shown in the display by pressing the **BSPC** soft key as many times as necessary.

## TEXT MESSAGING

This feature allows two digital keyset users to respond to each other with preprogrammed text messages. After receiving an Off Hook Voice Announcement or Station Camp-On, you may respond with a text message while continuing to talk and listen to your outside party. The other station can view this message and take the appropriate action or respond back with another text message.

You **must** be permitted to use the Text Messaging feature. See your System Administrator or Technician to be assigned this feature. They will assign you ten (10) blank messages. You can create any 16 character messages (01 to 10) that are appropriate for your use.

NOTE: See [ALARM REMINDER MESSAGES](#) for instructions on how to enter characters to create a text message.

Familiarization with the two digit message numbers you will use the most will make this procedure quick and easy. However if you do not know them, use the **UP/DOWN** button to scroll to the desired message, then press **SEND**.

The basics steps in text messaging are:

1. Press **TMSG** soft key to begin text messaging.
2. Dial the 2 digit number for the desired message.
3. Confirm this is the intended message then press **SEND**.
4. Wait for a reply from the other station (steps 1, 2 & 3)
5. When any station presses **EXIT** the displays at both stations return to their previous call progress condition.

At all times after step 1 you can talk and listen to your caller while repeating steps 2.

The following example will better demonstrate how to use Text Messaging. In this example station 201 is making an off hook voice announcement to station 205 who after hearing the announcement will respond with a text message.

**STATION 201: LINDA**

received a call on line 702

**STATION 205: JOHN**

is talking on line 701

Talking on line 702

<b>702 :</b>	<b>01 : 15</b>
<b>CONF</b>	<b>PAGE MUTE</b>

<b>701 :</b>	<b>05 : 25</b>
--------------	----------------

Press **TRANSFER**

**Transfer:**  
**RETURN**

Dial **205**

**205:busy**  
**OHVA**      **CAMP ON**



**OHVA to 205**

**OHVA from 201**  
**TMSG**      **REJECT**

**Wait for reply**

**GIVE THE CALL**  
**TMSG:01**      **SEND**

Dial **03** or press ↑ twice

**ASK THEM TO HOLD**  
**TMSG:03**      **SEND**



**ASK THEM TO HOLD**  
**TMSG**      **EXIT**



**Wait for reply**

**702:**      **01:45**  
**CONF**    **PAGE**    **MUTE**

**701:**      **05:55**  
**CONF**    **PAGE**    **MUTE**

# CALLER ID

## WHAT IS CALLER ID?

Caller ID is the name given to the telephone company-provided feature that delivers the telephone number and sometimes the name of the person calling your phone. There are two types of Caller ID; the first delivers the calling party's telephone number only and the second (sometimes referred to as "Deluxe" Caller ID) delivers both the calling party's telephone number and name as listed in the telephone directory.

The phone system can handle both types of Caller ID; in fact, in the case of number only delivery, the system can be programmed to insert a name for a specific telephone number. However, even though you are paying to receive Caller ID information, there are some circumstances that mean you will not receive this information. The six most common reasons are listed below along with the display information that the system will provide.

- |                  |  |
|------------------|--|
| PRIVATE          | The caller does not wish his/her name or number to be revealed to you. This type of call can be stopped at the telephone company by dialing an access code on your outside lines. This will redirect these PRIVATE calls to an announcement that states that you do not wish to receive calls that have had Caller ID blocked. The code to block these calls can usually be found in the front section of the telephone directory. |
| OUT OF AREA      | The caller is calling from an area that cannot provide Caller ID information (for example, international calls) or he/she is calling from a type of circuit that cannot provide Caller ID information, for example, some outbound WATS lines.  |
| PAYPHONE         | The caller is calling from a coin-operated telephone. The telephone company will send this information as there are no directory listings for pay phones. The number will be delivered as usual.   |
| INVALID CID INFO | This is a message that will be displayed when CID information is sent on the line but was somehow corrupted.   |
| NO CID RECEIVED  | This is a message that will be displayed when there was no CID information sent on the line.   |

NO CID DSP      Caller ID Digital Signal Processors (CIDDSP's) are resources in the OfficeServ 100, OfficeServ 500, and OfficeServ 7000 Series systems required for receiving CID data. If there are no CIDDSP's available at the time a call comes in, this is the message you will see on your display.

NOTE: The Caller ID features may require optional software and/or hardware. Please see your service and installation company for details.

## WHAT IS ANI?

[T1/E&M NOT SUPPORTED ON THE OS 7030, OS 7100 and OS 7200-S]

ANI (Automatic Number Identification) is a feature offered by some telephone service providers that provides the calling party's telephone number. This service is only available on E&M Tie Lines on a T1, digital trunk. ANI is similar to Caller Identification (CID) but the format and information of the calling person is different. CID uses FSK signalling and ANI uses DTMF signalling. Usually, with ANI, a calling party's identity is the Listed Directory Number (LDN) unless a separate bill-to-number has been specified, (in which case the bill-to-number will be sent). Note that ANI does not provide calling party NAME, only the number. The phone system can provide calling number to name translation table.

## WHAT IS CLI?

On ISDN circuits, calling party information is called CLI and is supported on both BRI (BRI not supported in the US) and PRI type circuits (not supported on OfficeServ 7030). On BRI circuits the system only supports number delivery and, like ANI, a name can be attached to the telephone number of frequent callers via the Caller ID translation table. On 5ESS and NI2 PRI circuits both name and number support is provided on the OfficeServ 100, OfficeServ 500, and OfficeServ 7000 Series systems.

## SELECTING YOUR CALLER ID DISPLAY

Simultaneous display of Caller ID name and number on incoming CO calls on both lines of display keysets is supported on all OfficeServ systems. On Transferred CO calls you can decide if you want to see the Caller ID name or Caller ID number in the display. Regardless of which data is selected, you can press the **NND** button to view the other pieces of Caller ID information. To select the type of Caller ID information you wish to view:

- With the handset on-hook, press **TRSF** and then dial **119**.
- To set the first line of a ringing call display dial **0**.
- To set the second line of a ringing call display dial **1**.

Set the data to display from the following:

- To show nothing dial **0**.
- To show Caller ID Number dial **1**.
- To show Caller ID Name dial **2**.
- To show the DID Number the call came in on dial **3**.
- To show the Name of the DID the call came in on dial **4**.
- To show the Name of the Group the call came in for dial **5**.
- To show the DID Number and then Name of the DID dial **6**.
- To show the Name of the DID and then the DID Number dial **7**.
- To set the top line of the display shown after answering a call dial **2**.  
Set the data to display from the following:
  - To show Caller ID Number dial **0**.
  - To show Caller ID Name dial **1**.
  - To show the DID Number the call came in on dial **2**.
  - To show the Name of the DID the call came in on dial **3**.
  - To show Caller ID Number and then the DID Number dial **4**.
  - To show Caller ID Name and then the DID Number dial **5**.
  - To show the DID Number and then the name of the DID dial **6**.
  - To show the Name of the DID and then the DID Number dial **7**.
  - To show the C.O. line information dial **8**.
- To set the format if the C.O. line information when the above is set to show C.O. line information dial **3**.
  - To show the C.O. line number and the dialed or Caller ID Number dial **0**.
  - To show only the dialed or Caller ID Number dial **1**.
- Press **TRANSFER** to exit and store your selection.

## VIEWING THE NEXT CALLER ID CALL

In the event that you have a call waiting or a camped-on call at your keyset, you can press the **NEXT** button to display the Caller ID information associated with the call in queue at your keyset. Either the CID name or CID number will show in the display depending on your Name/Number selection.

To view Caller ID information for calls that have been camped-on to your keyset, press the **NEXT** button. If your keyset does not have a **NEXT** button, press the **CID** button and then the **NEXT** soft key.

## SAVING THE CALLER ID NUMBER

At any time during an incoming call that provides CID information, you may press the **SAVE** button to save the CID number. If your keyset does not have a **SAVE** button, press the **CID** button, the **SCROLL** button and then the **SAVE** soft key. The system must be using LCR to dial the saved number.

## REDIALING A SAVED CALLER ID NUMBER

To redial a number that has been saved, press the **SNR** button or dial **17**.

### NOTES:

1. Your telephone system must have LCR correctly programmed to redial the saved number.
2. If the Hot Keypad feature has been turned off, you must first lift the handset or press the **SPEAKER** button before you begin dialing.

## STORING A CALLER ID NUMBER

At any time during an incoming call that provides CID information, you may save the CID number as a speed dial number in your personal speed dial list. To store a Caller ID number in a personal speed dial bin:

- Press the **STORE** button. The system displays the speed dial bin in which the number was stored, **OR**
- Press the **CID** button and then press the **SCROLL** button.
- Press the **STORE** soft key.
- The system displays the speed dial bin in which the number was stored.

NOTE: Your telephone system must have LCR correctly programmed to redial the saved number. If LCR is not being used on your system, you will not be allowed to STORE CID numbers.

## INQUIRE CALLER ID PARK/HOLD INFO

If you are informed that an incoming call is on hold or has been parked for you, you may view the Caller ID information before you retrieve the call. This may influence how you choose to handle the call.

From an idle keyset:

- Press the **INQUIRE** button, **OR**  
Press the **CID** button and then the **INQUIRE** soft key.
- Dial the trunk number.
- You may use **NND** to view more information about this call, **OR**  
You can return to the idle condition by pressing **IGNORE**.

If you are on a call:

- Press the **INQUIRE** button. Your existing call will go on hold, **OR**  
Press the **CID** button and then the **INQUIRE** soft key to place the first call on hold.

- Dial the trunk number.
- You may use **NND** to view more information about this call, **OR**  
You can return to the idle condition by pressing **IGNORE**.

### NOTES:

1. If you are on an intercom call or you have Automatic Hold turned off, you must finish the existing call or place it on hold before inquiring.
2. If you inquire about an outgoing call, you will receive a [call no longer available] display.

## REVIEWING PAST CALLER ID CALLS

This feature allows you to review CID information for calls sent to your keyset. This list can contain 10–50 calls in a last-in, first-out basis. The list includes calls that you answered and calls that rang your keyset but that you did not answer (missed calls). When reviewing this list, you can press one button to dial the person back. The system must be using LCR to dial the stored number. To access the CID information stored in your REVIEW list:

- Press the **REVIEW** button, **OR**  
Press the **CID** button and then press the **REVIEW** button.
- If you have entries in your review list, the most recent call will be shown first.
- You can now **CLEAR** this entry, **OR**  
Use **NND** to view more information about this call, **OR**  
Press **DIAL** to call this person back, **OR**  
Press **SCROLL** and then press **STORE** to save this number in a personal speed dial bin.

### NOTES:

1. Each keyset defaults with ten review bins. Please see your system administrator to determine the number of bins assigned to your keyset.
2. Your system must have LCR correctly programmed to allow you to **DIAL** numbers from the review list or to **STORE** entries from the review list.



# Samsung Voicemail

This section describes how to setup and use the various features available to a Subscriber. A Subscriber is a person that has been authorized access to the various features and services available in the Samsung Voicemail. Please review this section carefully before you use your Authorized Features and Services, known as Subscriber Services.

Voicemail is one of the Subscriber Services available. Your voicemail box has the capability of storing private messages, and offers a number of options for sending or redirecting messages as well as provides several ways to notify you of new messages.

Another very common Subscriber Service is Access Manager. This allows you control over when and where you receive your calls as well as what to speak to your callers in the event you are unable to speak to them directly. The 'events' are referred to as "Call Conditions": No-Answer, Busy, and Blocked are the most commonly used Call Conditions.

This guide can be used by Subscribers from within the office or from telephones outside the office. The basic operation is the same, but the access method will be different. [See the Subscriber Services Menu Diagram for more details.](#)

Note that some features and prompts detailed here may not be available to all Subscribers. See your System Administrator if you have questions about feature availability.

## ACCESSING YOUR MAILBOX

*[Also known as Subscriber Services Menu]*

### Inside Callers *[Subscriber logging in from their Desk]*

- Dial the voicemail access number or press the key assigned to ring voicemail **[VMMSG]**.
- Enter your personal password when prompted (the default password is 0000).

### Outside Callers *[Subscribers calling from Cell Phones or outside of the office environment]*

- Dial the phone number that will be answered by the voicemail. The main greeting will answer.
- At the main greeting dial **[#]** plus your Subscriber (or mailbox) number (Subscriber and Mailbox numbers will usually match your extension number).
- Enter your personal password when prompted (the default password is 0000).

### Access your Subscriber Services (or Mailbox) from a Station other than your Own (or checking a mailbox associated with a different station)

- Press the **[VMMSG]** key or dial the voicemail **group number**. You will be prompted to enter a password.
- Press **[\*]**. This will take you to the Main Auto Attendant Menu.
- Press **[#]** plus the Subscriber number of your choice. You will be prompted to enter your password.

At this point the inside and outside callers follow the same instructions. You will hear a message stating the number of messages left in your mailbox. You will then hear the Subscriber Services Menu with the following options:

- 1 Listen to New Messages - [See Listening to your Message.](#)**
  - 2 Record and Send Message - [See Sending Messages.](#)**
  - 3 Review Saved Messages - [See Listening to your Message.](#)**
  - 4 Access Manager - [See Access Manager.](#)**
  - 5 Personal Greetings - [See Personal Greetings.](#)**
  - 6 Mailbox Administration - [See Mailbox Administration.](#)**
- # Personal Services - [See Personal Services.](#)**
- \* Return to Main Menu.**

# Subscriber Services Menu

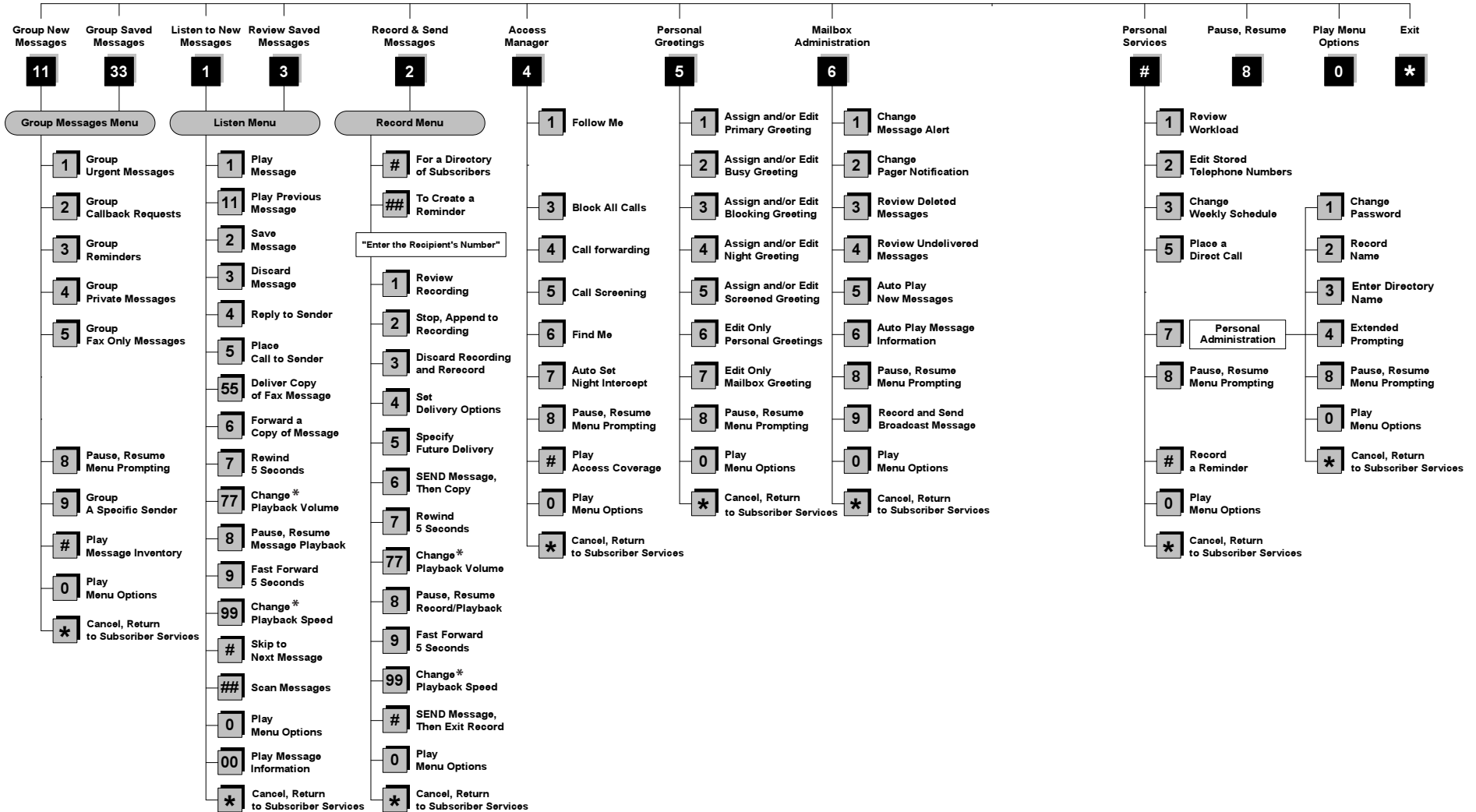

NOTE: All options shown MAY NOT be authorized. If an option is not available please speak to your system administrator.

\*Change Playback Volume and Speed not available on the OfficeServ 7030, OfficeServ 7100, OfficeServ 7200-S or OfficeServ IP-UMS.

## GETTING STARTED

Using your new Samsung Voicemail Subscriber Services is as simple as following a few simple spoken instructions. First time users should read this section as a tutorial. You should start with the following steps:

- Access your Subscriber Services Menu - You already know how to do this.

### From the Subscriber Services Menu:

- Record a Primary/No-Answer Personal Greeting. Dial **[5][1]**.
- Record a Mailbox Greeting. Dial **[5][7]**.
- Change your access code (Password). Dial **#[7][1]**.
- Record your name. Dial **#[7][2]**.
- Enter your directory name. Dial **#[7][3]**.

After you have completed the steps above your Subscriber Services are set up and ready to use.

## LISTEN TO YOUR MESSAGES

If there are new messages in your mailbox your **[VMMMSG]** key will be lit. Call the Samsung Voicemail by pressing this key, and when prompted enter your password. You will then be at the Subscriber Services Menu. Select **[1]** to listen to new messages or **[3]** to listen to saved messages.

Note: After you enter your password, if "Autoplay of New Messages" is enabled and you have new messages the Samsung Voicemail will begin to play them automatically. A subscriber can control this feature. From the Subscriber Services Menu **[6] [5]** toggles "Autoplay of New Messages" ON/OFF.

## SUBSCRIBER SERVICES MENU

The following is a list of all the options available in the Subscriber Main Menu.

- 1** LISTENING TO NEW MESSAGES
- 11** GROUP NEW MESSAGES
- 2** RECORD AND SEND A MESSAGE
- 3** LISTENING TO OLD MESSAGES
- 33** GROUP OLD MESSAGES
- 4** ACCESS MANAGER
- 5** PERSONAL GREETINGS
- 6** MAILBOX ADMINISTRATION
- 8** PAUSE / RESUME

- 0** PLAY MENU OPTIONS
- \*** EXIT TO AUTO ATTENDANT
- #** PERSONAL SERVICES

## 1 or 3

## LISTENING TO OLD OR NEW MESSAGES

- 1** Play / replay the message you just heard.
- 11** Play the previous message.
- 2** Save the message you just heard and listen to the next message.
- 3** Delete the message you just heard and listen to the next message.
- 4** Reply to the message.  
This will allow you to leave a message in the mailbox of the sender (if the sender has a mailbox on this system).
- 5** Return the call directly to the telephone number that left the message.  
This will work for internal and external callers, but Caller ID service is needed to use this feature on an outside call.
- 55** Deliver a fax copy.  
This will allow you to receive attached faxmail document(s). Faxmail documents can be delivered to any fax machine of your choice as long as out calling is authorized. You can also have faxmail messages automatically delivered to the fax machine of your choice.
- 6** Forward the message and saves a copy.  
The subscriber can be selected by dialing their mailbox number (nnn), using the directory service (#) or you may also add comments and leave it as a memo to yourself (##).  
The Send and Copy Service (option 6) allows a user to send copies of a message to multiple recipients easily. A different introduction message may be left for each recipient.
- 7** Rewind the message 5 seconds.
- 77** Change playback volume of the recording. **[Not available on OS 7030, OS 7100, OS 7200-S or OS IP-UMS]**  
There are two levels of volume during playback. Dialing this code will toggle between the two levels.
- 8** Pause or resume during message playback.
- 9** Fast forward the message 5 seconds.

- 99** Change playback speed of the recording. **[Not available on OS 7030, OS 7100, OS 7200-S or OS IP-UMS]**

There are two levels of speed during playback. Dialing this code will toggle between the two speeds.

- 0** Play options.  
Pressing this key will play all the menu options available to you from this point.
- 00** Hear the time and date, and sender's information of the message you just heard. Sender information is not available on outside calls.
- #** Move to the next message. This does not Save or Discard the current message - it is retained as new.
- ##** Scan. Plays first 7 seconds of a message then skips to next message. This is similar to the scan button on a radio. It will allow you to find a specific message quickly. To stop scanning press **[1]**.
- \*** Cancel and return to previous menu.

**11** or **33**

## GROUP NEW OR OLD MESSAGES

Messages can be grouped as either Reminders, press **[3]** or Messages from a specific sender, press **[9]**.

Additionally you can press **[#]** and hear a summary of your mailbox contents:

- Number of messages
- Number of reminders
- Number of urgent messages
- Number of messages needing a callback
- Number of private messages
- Number of fax messages

**2**

## RECORD AND SEND A MESSAGE

This option is used to send a message to another subscriber. The steps are simple:

- Enter the recipient's mailbox number, or if this is not known enter **[#]** to use the system directory.

- Record your message at the tone. After recording the message, you will hear the Send Menu with the following functions:

- Review
- Continue Recording
- Discard and Re-Record
- Set Message Attributes (Delivery Options)
- Schedule Future Delivery
- Save and Send then Send a Copy to Someone Else
- # Save and Send the Recording

## Setting Message Attributes

If after recording a message you select **[4]** you can set up any combination of the following delivery options:

- Urgent Delivery
- Return Receipt Requested
- Request a Call Back
- Private Delivery
- Reply Required
- \* Exit

## Scheduling Future Delivery

If after recording a message you select **[5]** to schedule future delivery, you will be able to set message attributes and set this message as:

- Immediate Delivery
- Next Few Hours
- End of Current Business Day (based on your Availability Schedule)
- Beginning of Next Business Day (based on your Availability Schedule)
- A Coming Day of the Week
- Specific Day / Time
- \* Exit

**4**

## ACCESS MANAGER

The Access Manager allows the subscriber to set a number of options for when, where and how, and/or if the Samsung Voicemail contacts you when a caller dials your extension number. All of the options are toggled on/off based on their current status when you access them.

**Note: ALL** Access Manager options **MUST** be individually allowed by the System Administrator for each Subscriber. They are:

#### 1 Follow Me

Allows the subscriber to enter an alternate location and set how long the new destination (Designated Location) will be active. This number may be an internal or external number. This is useful if you are frequently traveling or changing the number where you can be reached.

When Follow Me is activated, the transfer will be supervised and confirmed. This means that if the call is not answered or if rejected by the Subscriber at the designated location it will be recalled to the Subscriber's mailbox.

#### 3 Call Blocking

When this feature is active, callers will not be transferred to your extension, they will hear your 'blocked' greeting (if recorded) and will go directly to your mailbox if they do not select any or are not offered any other options.

#### 4 Call Forwarding

Unlike Follow Me where the subscriber wants to take their calls at an alternate location this feature allows the subscriber to pass control of his calls to another Subscriber. The "Forwarded To" Subscriber will now be in control of the caller and the caller will NOT return to originating Subscriber's Mailbox. If the "Forwarded To" Subscriber does not answer the caller it will now follow what ever the "Forwarded To" Subscriber has set up for their call conditions. The Caller will hear "Forwarding to" "{Subscriber Name}" before actually being forwarded.

#### 5 Call Screening

If this is turned on, the caller will be asked their name and the Samsung Voicemail will play this name to you before the transfer, giving you an option to accept or reject the call.

#### 6 Find Me

Find Me, when enabled, will attempt to locate the subscriber by calling a list of preprogrammed phone numbers. The stored phone numbers are entered in 'Personal Services' [#][2] (if allowed by the Administrator). The stored telephone number list can contain up to 9 preprogrammed telephone numbers. The Find Me feature only use the first five.

#### 7 Night Intercept

This feature is dependent on your weekly availability schedule, which is entered in 'Personal Services' [#][3] (if allowed by the Administrator). When Night Intercept is active the Samsung Voicemail will first ring your extension

then play your primary, No Answer greeting during the day (when you are available) and will NOT ring your extension but simply play your Night greeting during the night (when you are not available).

**Note:** This does NOT use the Day and Night schedules of the phone system. It is solely controlled by the Subscriber's Availability Schedule.

#### 8 Pause / Resume

#### \* Exit from Access Manager

#### 0 Play All Options

#### # Play Access Coverage

This feature is useful for finding out how you current access settings are set. It will also tell you what greetings will play under each of the call conditions you have setup.

## 5

## PERSONAL GREETINGS

The options available in this menu will be determined by your System Administrator, and not all of them may be available to you. In the simplest systems, only a mailbox greeting will be available, additional greetings may be accessible in more complex systems.

Your Personal Greeting will be played every time someone dials your extension and you do not answer.

You may record up to 9 Personal Greetings, and you may assign any one of them to be active. There are several different 'Call Coverage' conditions to which you may assign any of your 9 greetings. The Call Coverage Conditions are: No-Answer, Busy, and Do Not Disturb (or Forwarded All). This will allow different greetings to play depending on the type of call forward that you have set, or the condition of your telephone.

The Call Coverage conditions that you can assign specific greetings to are selected by the following digits:

#### 1 Primary/No Answer Greeting

Used when in your office, away from your desk or during the time period you are scheduled available. If this is the only Personal Greeting you record, it will play for all call coverage conditions.

This option is available only if the Administrator has assigned you the 'Basic Greeting' feature.

Example: "Hi this is John Smith. I'm sorry I am not available to answer your call. If someone else can help you, please enter the extension number now. Or, to leave me a message, press 1."

## 2 Busy Greeting

Played to a caller when you are already talking to someone on your extension or the telephone at your Designated Location.

This option is available only if the Administrator has assigned you the 'Busy Greeting' feature.

Example: "Hi, this is John Smith. I'm on another line right now. If someone else can help you, please enter the extension number now. Or, to leave a message, press 1."

## 3 Call Blocking Greeting

Used while Call Blocking is enabled in your Access Manager or if your phone is forwarded ALL or DND.

This option is available only if the Administrator has assigned you the 'Call Blocking' feature.

Example: "Hi, this is John Smith. Sorry I missed your call, but I'm going to be out of the office for the next few hours. If someone else can help you, please enter the extension number now. Or, to leave me a message, press 1."

## 4 Night Greeting

Used during the time period you are scheduled UNAVAILABLE, usually after business hours during the evening and at night.

This option is available only if the Administrator has assigned you the 'Scheduling' feature.

Example: "Hi, this is John Smith. I've left the office for the evening. If you would like to try someone else, please enter the extension number now. Or, to leave me a message, press 1."

## 5 Call Screening Greeting

Used while Call Screening is enabled, and you REJECT a caller after listening to the caller's record name.

This option is available only if the Administrator has assigned you the 'Call Screening' feature.

Example: "Hi, this is John Smith. I'm sorry, but I am not available to speak with you at this time. If someone else can help you, please enter the extension number now. Or, to leave me a message, press 1."

## 6 Edit Personal Greetings

You may also edit/record each one of the greetings (1-9) at any time.

Select a greeting number to edit and follow the instructions to record your greeting. When you are done recording your greeting, you will be able to listen to the greeting you recorded, save the greeting you recorded and return to the previous menu, record the greeting again, or exit without saving the greeting.

Note: If you record only the greeting assigned to the No-Answer Call Coverage Condition, then that greeting will play to callers for all Call Coverage Conditions (No-Answer, Busy, Blocked, Night, and Rejected Caller). In this case, the salutation part of the greeting should be very general.

## 7 Edit Mailbox Greeting

Used whenever a caller reaches your mailbox or if you have not recorded any of the Call Coverage greetings. The way a caller is transferred to your mailbox greeting directly, is by another subscriber transferring the caller to your mailbox using the VT (VoiceMail Transfer) key.

This option is available only if the Administrator has assigned you the 'Mailbox Greeting Option' feature.

Example: "Hi, this is John Smith. Please leave me a message, I will call you as soon as I can."

Note: This greeting will only play if none of the 5 personal greetings has played to the caller. A common usage for this Greeting is when another Subscriber is talking with a caller and uses the VT key on their phone to transfer the caller directly to your Mailbox.

# 6

## MAILBOX ADMINISTRATION

The Mailbox Administration menu is used to turn on and off your pager notification, message alert options and other message control features.

### 1 Message Alert

When this function is activated, the Samsung Voicemail will call any outside or inside telephone number, after each message is left in your voice mailbox.

To hear your message at the remote location when the Samsung Voicemail calls you, after you pick up the telephone and answer you will be instructed that there is a message and to enter your password. Simply enter your password and you will now be logged in.

### Setting Up Message Alert:

- From the Subscriber Services Menu press **[6]** for Mailbox Administration.
- Press **[1]** for Message Alert.
- There are 4 options available to you:
  - Press **[1]** to toggle message alert on and off.
  - Press **[2]** to set the schedule when you would like to be notified.
  - Press **[3]** to be notified on urgent messages only.
  - Press **[4]** to set the destination phone number.

## 2 Pager Notification

When this function is activated, the Samsung Voicemail will call your beeper service and notify you after each message is left in your voice mailbox.

- From the Subscriber Services Menu press **[6]** for Mailbox Administration.
- Press **[2]** for pager notification.
- There are 4 options available to you:
  - Press **[1]** to toggle pager notification on and off.
  - Press **[2]** to set the schedule when you would like to be paged.
  - Press **[3]** to be notified on urgent messages only.
  - Press **[4]** to set the pager phone number.

## 3 Undelete

When this function is activated, the Samsung Voicemail will allow you to undelete any messages that you have recently deleted (up to the programmed Daily Maintenance Time, which is set to 3 a.m. by Default the following morning).

- From the Subscriber Services Menu press **[6]** for Mailbox Administration.
- Press **[3]** for Deleted Messages.

Deleted voicemail messages are temporarily stored in memory until 3 a.m. the following day. Select this option to recover ("undelete") previously deleted messages, during this period of time.

## 4 Undelivered Retrieval

When this function is activated, the Samsung Voicemail will allow you to recall any messages you have sent that have NOT yet been picked up by the recipient.

- From the Subscriber Services Menu press **[6]** for Mailbox Administration.
- Press **[4]** for Undelivered Messages.

This useful feature will allow you to cancel any messages that have NOT yet been picked up by the recipient.

## 5 Auto Play New Messages

If this option is enabled, after you enter your password correctly any new messages will immediately begin to play. To enable (or if already enabled toggle and disable) this feature:

- From the Subscriber Services Menu press **[6]** for Mailbox Administration.
- Press **[5]** to Set Auto Play of New Messages.

## 6 Auto Play Message Information

If this option is enabled, the date, time and sender's name will be played automatically before each message. If this is disabled, the information must be requested manually by pressing '00'. To enable (or if already enabled toggle and disable) this feature:

- From the Subscriber Services Menu press **[6]** for Mailbox Administration.
- Press **[6]** to Set Auto Play of Message Information.

# 9

## MESSAGE BROADCAST

This option will only be available if it has been allowed by the System Administrator.

### Broadcast to All Mailboxes

If you have been designated as a Subscriber Administrator, you may send a message to ALL mailboxes in the system.

- From the Subscriber Services Menu press **[6]** for Mailbox Administration.
- Press **[9]** for Broadcast Messages.

This option will only be available if your mailbox has been assigned Subscriber Administration privileges.



## PERSONAL SERVICES

The Personal Administration Menu is used to set your password and record your name. Many of these features must be allowed by the System Administrator.

### 1 Workload Management

Allows you to access to all reminders, both Active and Pending. If authorized you can group your reminders as Commitments, Follow-Ups or Tasks for better organization. The system will flag each reminder as Active or Pending (pending means scheduled for future delivery).

### 2 Stored Numbers

Allows you to enter up to 9 stored phone numbers. The first five of these are used in the 'Find Me' feature, but any of them (1-9) can be easily dialed using only one digit followed by the pound key, to be used by many other features from within your subscriber space. (ie: "Follow Me," "Message Alert," "Pager Alert," and "Direct Call").

### 3 Schedule Availability

Allows you to enter a weekly availability schedule for use with Night Personal Greeting and the Auto Night Intercept feature. Follow the spoken directions to enter the days of the week and times you are generally available to talk to your callers. All other times you will be considered unavailable.

### 5 Place a Direct Call

Allows you to place a direct call out of the Samsung Voicemail from anywhere. You may either dial the number or dial a single digit 1-5 that corresponds to a stored number ([See Personal Services, 2 - Stored Numbers](#)). This feature must be authorized by the System Administrator and can be limited or opened to internal, local, and long distance calls.

### 7 Personal Administration

This area is used during the initial set up of your Subscriber Settings ([see next section](#)).

## PERSONAL ADMINISTRATION SETTINGS

This menu allows you to make changes to basic setup settings, that are rarely changed. Use these when you initially set up your personal Subscriber settings. You probably will not need to change them after that.

### 1 Setting your Password

- From the Subscriber Services Menu press **[#][7][1]**.
- The current password will be played and you will have the chance to change it.

### 2 Recording your Name

Use this option to record your name. Your recorded name is played in several different situations. It is important to record your name for proper operation of the Samsung Voicemail system.

- From the Subscriber Services Menu press **[#][7][2]**.
- The current name will be played and you will have the chance to change it.

Note: It is possible that if you do not record your name and/or enter your Directory Name (described below), you will not be included in the Dial by Name Directory.

### 3 Entering your Directory Name

Use this option to enter your Directory Name. Your Directory Name is used by callers to find you if they do not know your extension number.

- From the Subscriber Services Menu press **[#][7][3]**.
- The current Directory Name will be played as a string of digits that are equal to your name spelled out on your telephone keypad. Follow the instructions to enter a new name. You will be prompted to enter your last name and then your first name.

This must be done in order for the directory feature to work correctly.

Note: It is possible that if you do not record your name (described above) and/or enter your Directory Name, you will not be included in the Dial by Name Directory.

### 4 Extended Prompting

Use this option to drastically reduce the number of prompts played in the subscriber interface (mailbox prompts). Change this setting only if you are very familiar with the user operation of the Samsung Voicemail.



Note: Remember if you know what digits to press, you can enter them at any time you do not have to wait to be prompted. This feature can be toggled on/off at anytime. Also if it is off you will be prompted within each subscriber menu to press zero for more options. This enables you to still be able to find out what to do if you were to get lost and extended prompting was disabled.

## KEYSET USER FEATURES

The following options are available if you have a display keyset. They require setup by the System Administrator.

### Message Waiting Lights

When new messages are left in your mailbox, the voicemail message light on your keyset will flash. Press this flashing key [**VMMMSG**] and follow the prompts to retrieve messages. This key may be pressed at any time to log into your Subscriber Main Menu.

### Answer Machine Emulation

If you have an Answer Machine Emulation key programmed on your keyset, you can use it to monitor calls going to your voicemail, and optionally answer them. The operation of this feature is similar to screening a call on a home answering machine.

Your keyset must be set to forward on no answer to voicemail. After ringing your station the caller will be connected to your voicemail and hear your personal greeting before leaving a message. During this time you will be monitoring the connection between the caller and your voicemail box. At this time you will only be monitoring the call, you can not talk to the other party until you answer. You may pick up the call at any time or ignore it.

To activate this feature press the **AME** button. The associated indicator will be lit steady. Press again to turn off. If this key is pressed while a station is ringing (during forward no answer), the feature will be turned on for the current call only.

While the caller is leaving a message or ringing you may:

- Press [**#**] to immediately put the caller in your voice mailbox and monitor it.
- Press [**\***] to immediately disconnect your station. The caller continues to leave a message normally.
- Pick up the handset and monitor privately.

## AME Password

If your keyset has **AME PASSWORD** (MMC 110) set to **YES**, you must enter your station password to listen to messages being left. This will prevent unauthorized people from listening to messages being left for you.

If the password option is turned on, while a message is being left, press the flashing **AME** indicator and enter your station password (not your Samsung Voicemail password). You will then hear the message being left.

## Call Record

If you have a call record button assigned to your phone, you may press it at any time, to record the conversation in progress. If you have a display keyset, you will also have the soft key options to pause and time the message.

## SHORTCUTS

### Calling

Calling a station that is busy or does not answer you can press [#] to immediately send the call to the called parties mailbox.

### Call Divert to Voicemail

While receiving an incoming (ringing) call, dial [\*] to immediately send the caller to your personal voicemail box. This will override the call forward no answer setting.

### Direct Messaging

[#] + DSS To make it easy to leave messages for others in your office without having to dial their extension number first, keyset users may simply dial [#] plus a mailbox (extension) number and leave a message directly. If you dial a busy extension press [#] to connect directly with the mailbox.

### Self Memo (Reminder)

Pressing [##] will leave a message in your own mailbox. This is useful to remind yourself of things to do now or in the future. Messages can be sent with future delivery so you can have the system call you when items become due.

## INTERACTIVE DISPLAYS

Display keyset users have the added advantage of using the soft keys and displays to play, save, delete, reply, call, forward, rewind, pause, fast forward, change the volume, get message information, or help.

### Viewing Mailbox Contents

If you have new messages, in addition to the Terminal Status Indicator (TSI) you will be able to use the keyset displays and soft keys to communicate with the Samsung Voicemail.

## E-MAIL GATEWAY (EMG)

The E-Mail Gateway feature integrates your voice mail box with your email client. No matter what email client software you are using or where you use it, you can send voice mail messages and fax mail messages to your E-Mail inbox.

There are two parts to the E-Mail Gateway; E-Message Delivery and E-Message Notification.

- E-MESSAGE DELIVERY:** Voice mail messages (.wav) and/or fax mail messages (.tiff) are "delivered" to your Inbox with the appropriate attached file.
- E-MESSAGE NOTIFICATION:** You will receive an e-mail, with NO attachments, notifying you that you have a voice and/or fax mail message in your Voice Mail Box.
  - As a subscriber you can use either E-Message Delivery and/or E-Message Notification.
  - As a subscriber you can have multiple e-mail addresses. (a maximum of 5 valid email addresses).
  - E-Message Notification can be set to one e-mail address while E-Message Delivery is set to different e-mail address.

## Functionality

- With either type of EMG, when Caller ID (CID) is provided, the callers telephone number will appear in the subject field of the email along with the date and time stamp of when the voice message was originally recorded in your Voice Mail Box.
- If the caller is also a subscriber on the system and the E-Mail Gateway is set up with a valid "Reply To" address, the Subscriber's name will also appear in the "From" field. Otherwise, the "From" field will display the name of the Samsung voice mail system (SVMi-8E, SVMi-16E, or SVMi-20E) sending the message.
- Client will use their PC's Multi-Media kit (equipped with either speakers and/or a headset) to listen to messages delivered to their e-mail Inbox.

**IMPORTANT NOTE:** If the PC/Laptop/PDA/Smart Phone/etc... is not equipped with hardware and software capable of playing a '.WAV' file then the E-Mail Gateway will not work for them until they add some method to listen to '.WAV' files delivered to their Inbox.

The same applies to Fax Mail messages, if the device the subscriber is using does not support the viewing of '.TIFF' files, then the E-Mail Gateway for Fax Mail will not work for them until they add some method to view .tiff files delivered to their inbox.

- No Synchronization of messages is performed between the Voice Mail Box and the E-mail Inbox.
  - Messages listened to, forwarded, deleted, and/or saved within an e-mail inbox will NOT effect the status of that same new message in the Voice Mail or the MWI (Message Waiting Indicator) associated with that message on the phone.
  - Also messages listened to in the Voice Mail, from a phone, will not change the Unread/Read status of the same message in an e-mail inbox.

- However, the Voice Mail Administrator can adjust parameters per subscriber or group of subscribers that decide how, when, or if to delete the original voice message after it is sent to the E-Mail Server.
- When full synchronization of messages between Voicemail Box and E-mail Inbox is required, ask your Samsung representative about the OfficeServ IP-UMS. This is an Internet Protocol based fully synchronized Unified Messaging System.

## Benefits

- Store and Archive Voice and Fax Mail Messages in visible folders.
- Voice and Fax Mail Messages can now easily be dragged and dropped into folders the same way e-mail messages are organized and saved.
- Voice and Fax Mail Messages are now essentially the same as any other e-mail message.
- Backups and Message Archives can be made when they are made for all other types of e-mail messages.
- Add text notes and comments to use for reference later.
- Some (if not all) e-mail clients will allow you to edit the body of the e-mail to add comments.
- Some will allow you to edit the subject field to help you find a particular message quickly in a large archive of messages.
- Call Back Numbers and Date & Time Stamp are easily displayed in the Subject field.
- Easily forward Voice messages received, to others even if they are not a Voice Mail Subscriber on your system.
- No EMG System or Client Software to load on your Local PC or Network Servers.

Therefore compatible with most:

- E-Mail providers and E-Mail Clients
- PCs, Laptops, PDA, and/or Smartphones

**NOTE:** If you are not sure you have this functionality on your system and you would like to use it, please contact your on Site system administrator to see if it is available.

## PERSONAL SPEED DIAL NUMBERS

CODE	NAME	TELEPHONE NUMBER
00	_____	_____
01	_____	_____
02	_____	_____
03	_____	_____
04	_____	_____
05	_____	_____
06	_____	_____
07	_____	_____
08	_____	_____
09	_____	_____
10	_____	_____
11	_____	_____
12	_____	_____
13	_____	_____
14	_____	_____
15	_____	_____
16	_____	_____
17	_____	_____
18	_____	_____
19	_____	_____
20	_____	_____
21	_____	_____
22	_____	_____
23	_____	_____
24	_____	_____

# PERSONAL SPEED DIAL NUMBERS

CODE	NAME	TELEPHONE NUMBER
25	_____	_____
26	_____	_____
27	_____	_____
28	_____	_____
29	_____	_____
30	_____	_____
31	_____	_____
32	_____	_____
33	_____	_____
34	_____	_____
35	_____	_____
36	_____	_____
37	_____	_____
38	_____	_____
39	_____	_____
40	_____	_____
41	_____	_____
42	_____	_____
43	_____	_____
44	_____	_____
45	_____	_____
46	_____	_____
47	_____	_____
48	_____	_____
49	_____	_____

## System Feature Codes

### Line Groups

- 9 Local/LCR \_\_\_\_\_
- 800 \_\_\_\_\_
- 801 \_\_\_\_\_
- 802 \_\_\_\_\_

### Station Groups

- 501 \_\_\_\_\_
- 502 \_\_\_\_\_
- 503 \_\_\_\_\_
- 504 \_\_\_\_\_

### Paging Zones - Dial 55 plus

- 0 All Internal Zones \_\_\_\_\_
- 1 \_\_\_\_\_
- 2 \_\_\_\_\_
- 3 \_\_\_\_\_
- 4 \_\_\_\_\_
- 5 \_\_\_\_\_
- 6 \_\_\_\_\_
- 7 \_\_\_\_\_
- 8 \_\_\_\_\_
- 9 All External Zones \_\_\_\_\_
- \* All External Zones and Internal Zone 0 \_\_\_\_\_

### Programmed Messages - Dial 48 plus

- 00 Cancel Message \_\_\_\_\_
- 01 In A Meeting \_\_\_\_\_
- 02 Out On A Call \_\_\_\_\_
- 03 Out To Lunch \_\_\_\_\_
- 04 Leave A Message \_\_\_\_\_
- 05 Page Me \_\_\_\_\_
- 06 Out Of Town \_\_\_\_\_
- 07 In Tomorrow \_\_\_\_\_
- 08 Return Afternoon \_\_\_\_\_
- 09 On Vacation \_\_\_\_\_
- 10 Gone Home \_\_\_\_\_
- 11 \_\_\_\_\_
- 12 \_\_\_\_\_
- 13 \_\_\_\_\_
- 14 \_\_\_\_\_
- 15 \_\_\_\_\_
- 16\* \_\_\_\_\_
- 17\* \_\_\_\_\_
- 18\* \_\_\_\_\_
- 19\* \_\_\_\_\_
- 20\* \_\_\_\_\_

### Feature Access Codes

- 10 + xxx Pick Up A Parked Call
- 12 + xxx Pick Up A Held Call
- 13 Door Lock Release
- 16 + xxx Speed Dialing
- 17 Save And Redial Number
- 18 New Call (Recall)
- 19 Last Number Redial
- 400 Cancel Do Not Disturb
- 401 Set Do Not Disturb
- 42 + xxx Cancel Message Wait
- 43 Return Message
- 44 Callback
- 45 Busy Station Camp-On
- 46 Conference
- 47 Account Code
- 48 + xx Programmed Messages
- 49 Send Flash To C.O. or PBX
- 53 + xxx In/Out of Group
- 54 Meet Me Page
- 56 Meet Me Page Answer
- 600 Cancel All Call Forward
- 601 + xxx Set Forward All Calls
- 602 + xxx Set Forward Busy
- 603 + xxx Set Forward No Answer
- 604 + xxx Set Fwd Busy/No Answer
- 605 + xxx Set Forward on DND
- 606 + xxx Set Forward Follow Me
- 65 + xxx Pick Up Ringing Extension
- 66 + xx Group Call Pick Up
- 67 Universal Answer
- \* Authorization Code

\*Programmed Messages 16-20 not available on OS 7030, 7100, and 7200-S.



# DS-5000 Series

## Keypad User Guide

Enterprise IP Solutions

# OfficeServ™

DS 5000 Series User Guide

*For OfficeServ™ 100, OfficeServ™ 500, and  
OfficeServ™ 7000 Series*



SAMSUNG

# TABLE OF CONTENTS

<b><u>ABOUT THIS BOOK</u></b> .....	1
<b><u>THINGS YOU SHOULD KNOW</u></b> .....	2–8
<b><u>ASSEMBLING YOUR KEYSET</u></b> .....	9
<b><u>DS 5000 KEYSETS SETUP</u></b> .....	10
<b><u>OUTSIDE CALLS</u></b>	
<u>Making an Outside Call</u> .....	11
<u>Answering an Outside Call</u> .....	11
<u>Universal Answer</u> .....	11
<u>Recall/Flash</u> .....	12
<u>Busy Line Queuing with Callback</u> .....	12
<u>Canceling Callback</u> .....	12
<b><u>INTERCOM CALLS</u></b>	
<u>Calling Other Stations</u> .....	13
<u>Answering Intercom Calls</u> .....	13
<u>Answer Modes</u> .....	13
<u>Busy Station Callback</u> .....	14
<u>Busy Station Camp-on</u> .....	14
<u>Calling Your System Operator</u> .....	15
<b><u>CALL PROCESSING</u></b>	
<u>Holding Calls</u> .....	16–17
<u>Transferring Calls</u> .....	17–18
<u>Transfer with Camp-On</u> .....	18
<u>Transfer to Voicemail</u> .....	18
<u>Call Waiting</u> .....	18
<u>Conference Calls</u> .....	19
<u>Forwarding Calls</u> .....	20–21
<u>Call Pickup</u> .....	22
<u>My Group Pickup</u> .....	22
<u>Privacy Release</u> .....	23

Copyright 2007-2009 Samsung Telecommunications America.

All rights reserved. No part of this manual may be reproduced in any form or by any means—graphic, electronic or mechanical, including recording, taping, photocopying or information retrieval systems—without express written permission of the publisher of this material.

Samsung Telecommunications America reserves the right without prior notice to revise information in this guide for any reason. Samsung Telecommunications America also reserves the right without prior notice to make changes in design or components of equipment as engineering and manufacturing may warrant. Samsung Telecommunications America disclaims all liabilities for damages arising from the erroneous interpretation or use of information presented in this guide.

## **DIALING FEATURES**

Speed Dialing .....	24
Programming Personal Speed Dial Numbers .....	24–25
One Touch Speed Dialing .....	25
Last Number Redial .....	25
Manual Retry with Redial .....	26
Save Number with Redial .....	26
Chain Dialing .....	26
Automatic Redial/Retry .....	26
Pulse to Tone Changeover .....	27
Memo Redialing .....	27

## **PAGING AND MESSAGING**

Making an Internal Page .....	28
Making an External Page .....	28
All Page .....	28
Meet Me Page .....	29
Call Park and Page .....	29
Messages—Set and Cancel .....	30
Returning Messages .....	30
Programmed Messages .....	31

## **CONVENIENCE FEATURES**

Do Not Disturb .....	32
One Time DND .....	32
Mute .....	32
Background Music .....	32
Established Call Pick-Up .....	33
Appointment Reminder/Alarm Clock .....	33
Door Phone Calls .....	34
Executive/Secretary Hotline .....	34
Executive Divert .....	34
Group Listening .....	35
Account Codes .....	35
Locking Your Keypad .....	36
Manual Signalling .....	36
Off-Hook Voice Announce .....	36
OHVA Block .....	37
OHVA Reject .....	37
In Group/Out of Group .....	37

## **CUSTOMIZING YOUR KEYSSET**

AME Password .....	39
Auto Camp-On .....	39
Select Ring Tone .....	39
Change Your Passcode .....	39
Set Answer Mode (Intercom) .....	40
Set Answer Mode (CO) .....	40
Automatic Hold .....	40
Headset Operation .....	40
Hot Keypad .....	41
Key Confirmation Tone .....	41
Rejoining a Page .....	41
Ring Preference .....	41
Auto Answer CO Calls .....	42
Display Speed Dial Name .....	42
Caller ID Review All .....	42
Secure OHVA .....	42
Enblock Dialing .....	43
Configure Mobile Extensions (MOBEX) .....	43

## **DISPLAY FEATURES**

Interactive Display Keys .....	45
Directory Information .....	45
Call Log .....	46
Dial by Name .....	46
Call Progress Displays .....	47
Display Number Dialed .....	47
Call Duration Timer .....	47
Auto Timer .....	47
Timer Function .....	47
Viewing Message Indications .....	48
Alarm Reminder Messages .....	48–49
Personal Speed Dial Names .....	49
Station Names .....	49
Managing Key Assignments .....	50
LCR with Clear .....	50
Backspace with LCR .....	50
Text Messaging .....	51–52
Caller ID .....	53–56
ANI .....	54–56
CLI .....	54–56

<b>SPECIAL APPLICATION MENU</b>	58
Menu Options	58–60
Outgoing Call Log	58
Incoming Call Log	58
Speed Dial	59
Directory Dial	59
Forward Set	59
Alarm Reminder	60

<b>Samsung Voicemail</b>	60
Subscriber Services Menu Diagram	62–63
Accessing your Mailbox	65
Getting Started	65
Listen to your Messages	65
Subscriber Services Menu	65
Listening to Old or New Messages	66
Group New or Old Messages	66
Record and Send a Message	67–68
Access Manager	68–70
Personal Greetings	70
Mailbox Administration	72
Message Broadcast	74
Personal Services	75
Personal Administration Settings	76
Keypad User Features	77
Shortcuts	79
Interactive Displays	79
E-Mail Gateway (EMG)	79–81

<b>PERSONAL SPEED DIAL NUMBERS</b>	82–83
------------------------------------	-------

## ABOUT THIS BOOK

Samsung's new DS 5000 Series is part of the OfficeServ 100, OfficeServ 500, and OfficeServ 7000 Series.

The DS 5000 keysets incorporate an LCD screen, which provides important information for the user, to make using the keyset easier and more convenient.

Your keyset is the most visible part of your telephone system. Please take the time to study this guide and to become familiar with the operation of your keyset. Keep this guide handy, as you may need to look up instructions for infrequently used features.

Learning to use your keyset correctly will make everyday telephone communications a breeze.

This book is written based on the factory default settings for the feature access codes. Sometimes, due to programming requirements, these codes may be changed. If you find that a feature code does not work as described in this book, please contact your installation and service company to determine the correct code.



# THINGS YOU SHOULD KNOW

## USER ORIENTATION

The DS Series keysets incorporate buttons or “keys” that are used to access or activate the many features of your office phone system. The DS 5021D keysets incorporate 21 programmable buttons. These 21 buttons are arranged in three rows of seven across the face of the keyset. Any of the system features or functions can be programmed to these buttons.

The three buttons above the top row of programmable buttons are soft keys. These buttons assist in the use of the system features and functions.

Lines from the telephone company are “C.O. lines.” Calls on these lines are referred to as “outside calls.” Your system can have individual C.O. line keys or lines may be assigned to groups. When they are in a group, you access a line by dialing an access code or pressing a route button. For example, dial 9 or press a “LOCAL” button to get a local outside line. If Least Cost Routing is used, pressing the “LCR” button will automatically select a preprogrammed C.O. line according to what digits are dialed. Each line in the system is numbered, beginning with 701, then 702, 703, etc.

Direct Station Selection (DSS) buttons are programmed to ring specific stations. You can press a DSS button instead of dialing the extension number.

## CALL INDICATIONS

The buttons on your phone have light emitting diodes (LEDs). These are tri-colored LEDs that light green, red or amber (green and red together).

Intercom calls, also called internal calls, always appear on your CALL buttons. They will always light green. You can have up to eight CALL buttons, but at least two are recommended.

Outside calls appear on individual line buttons if they are assigned. When an individual line is not assigned to its own button, it will appear on a CALL button.

Your outside calls will light green on your keyset and red on other keysets. You never lose sight of your calls while they are on hold. They stay right where you put them and are identified with a green flashing light.

Some simple rules to remember:

- Any steady LED indicates the line or feature is in use.
- A fast flashing green LED indicates a new call ringing in.
- A slow flashing green or red LED indicates a call is on hold.
- A slow flashing amber LED indicates a recall to your keyset.

## SPEAKERPHONE

All DS keysets are speakerphones. Pressing the **SEND** button will answer an incoming call on the speakerphone. Pressing the **END** button will release the call on the speakerphone.

Switching from the handset to the speakerphone is easy. Simply press the **SPEAKER** button and hang up the handset.

## VOLUME CONTROLS

The DS 5000 keysets use the **UP** and **DOWN** buttons to adjust the ringer volume while the keyset is ringing, the speaker volume while the speakerphone is in use and the handset volume while you are listening. These three levels will be stored in memory until changed. If background music is turned on at your keyset, the volume buttons will also control the level of music. The volume of pages heard through the speaker of a keyset can be adjusted during a page announcement by using the volume buttons. There are 16 levels for each volume setting. The volume of off-hook ring is controlled by a user-programmable setting.

## TERMINAL STATUS INDICATOR

The terminal status indicator light is positioned on the top right corner of the keyset above the display. The terminal status indicator is a tri-colored (red, green, and amber) light that provides greater visibility of your keysets status than the individual button LEDs. The terminal status indicator provides the following indications:

- |                     |                                      |
|---------------------|--------------------------------------|
| • Busy/Off Hook     | Steady Red                           |
| • Intercom Ring     | Flashing Red                         |
| • Outside Call Ring | Flashing Green                       |
| • Recall Ring       | Flashing Amber                       |
| • Message Waiting   | Flashing Red                         |
| • Do Not Disturb    | Fast Flash Red at 1 Second Intervals |

## CONFERENCE BUTTON

The **CONFERENCE** button allows the user to set up a call with up to 5 parties (station or trunk).

## TRANSFER BUTTON

Transfer is used to send any call to another extension in one of two ways. You can do a screened transfer by informing the other extension who is calling or you can do a blind transfer without notification.

## HOLD BUTTON

The **HOLD** button maintains the call at your keyset, while enabling you to call other stations or consult coworkers in confidence.

## SPEAKER BUTTON

The **SPEAKER** button allows you to have a conversation from the keyset without lifting the handset.

## NAVIGATION BUTTON

The DS 5000 keysets incorporate a NAVIGATION button. This button is designed to assist the user in activating and using various station features, more easily. These features include:

- Outgoing Logs
- Incoming Logs
- Speed Dial
- Directory Dial
- Forward Set
- Alarm Reminder

With the **NAVIGATION** button the station user is no longer required to enter station level programming to activate these frequently used features. A few button presses and these features are activated.

The **NAVIGATION** button is divided into separate feature buttons. These buttons are described below.

- **MENU BUTTON:** This button displays the station feature main menu so that the users can easily utilize various settings and helpful functions.

- **SEND BUTTON:** If the station is programmed for **Enblok Dial Mode**, when dialing an outside telephone number or internal station number, you must press the **SEND** button to initiate the call. This button is also used when reviewing recently received or called numbers and answering incoming calls. When reviewing recently received calls, continue to press the **SEND** button for more than 2 seconds and the last outside number called will be redialed. The **SEND** button operates as the **ANS** portion of the **ANS/RLS** button. An **ANS/RLS** button may be assigned to the station as a programmable button.
- **ENTER BUTTON:** This button is used to select a menu option, or to save changes made to a menu or submenu option.
- **DIRECTION BUTTON:** The **DIRECTION BUTTON** is the donut shaped ring, which surrounds the **ENTER** button. This button is used to navigate within the menus. There are directional arrows stenciled into this button, which indicate which direction the cursor will be moved.
- **END BUTTON:** This button is used to disconnect a call after a conversation or to move to the initial screen. The **END** button operates as the **RLS** portion of the **ANS/RLS** button. An **ANS/RLS** button may be assigned to the station as a programmable button.
- **CANCEL BUTTON:** This button is used to erase any characters or numbers entered by the dial pad or to move to the previous screen.

## FEATURE ACCESS CODES

This user guide is written based on the default access code for using system features. If the system numbering plan has been changed some of the access codes may not be correct. Your installing company can inform you of the correct codes.

# SYSTEM TONES

The system provides several tones to assist you. Some of these tones are already familiar to you.

Intercom Dial Tone—A steady tone that indicates you can begin dialing.

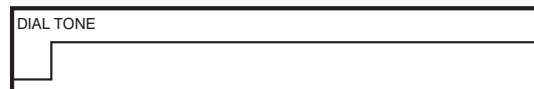

CONTINUOUS

Ringback Tone—Indicates the station you dialed is ringing.

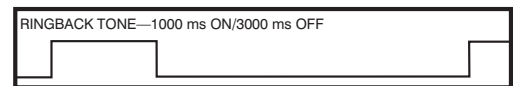

CONTINUOUS

Busy Tone—Indicates the station you dialed is busy.

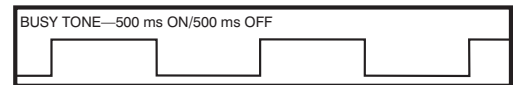

CONTINUOUS

DND/No More Calls Tone—Fast busy tone indicates the station you dialed is in the Do Not Disturb mode or cannot receive any more calls.

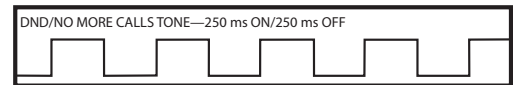

FOR TEN SECONDS

Transfer/Conference Tone—Indicates your call is being held and you can dial another party.

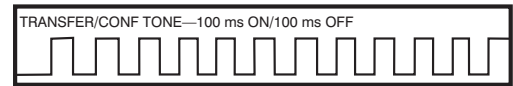

CONTINUOUS

Confirmation Tone—Very short beeps followed by dial tone indicate you have correctly set or canceled a system feature.

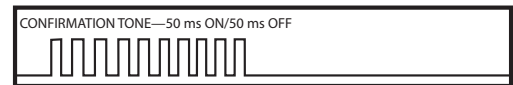

FOR ONE SECOND (programmable)

Error Tone—A distinctive two level beeping tone indicates you have done something incorrectly. Try again.

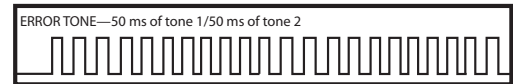

FOR THREE SECONDS

# DS 5021D





# DS 5014D



## DS 5007S



## ASSEMBLING YOUR KEYSSET

- Place the keyset face down on a flat surface.
- Insert notched ends of the support bracket into the channels located in the upper section of the bottom panel. Push towards the top of the keyset to lock in.
- Plug the handset cord into the jack marked with the  symbol.
- Route the handset cord out the **RIGHT** side of the keyset as you look at it face down.
- Plug the four-conductor line cord, from the wall, into the jack with the  symbol on the bottom of the keyset.

## DS 5064B AOM



**64 PROGRAMMABLE KEYS WITH RED LIGHTS** Used to call stations directly, to indicate busy conditions of other stations, for One Touch dialing and many other system features.

## KEYSET DAUGHTER MODULE [5021D & 5014D ONLY]

DS 5021D keysets can have one type of daughter module installed to enhance the operation of the keyset, the FDBF. The standard speakerphone mode of operation for the DS 5021D is "half duplex." This means that you cannot transmit and receive speech at the same time. Adding a FDBF to your keyset will convert the speakerphone into full duplex mode enhancing its operation. In addition the FDBF may have up to three (3) external microphones attached to it for conference room type applications. These microphones require an "EXTMIC" key programmed on the keyset to activate or deactivate them.

# DS 5000 SETUP

## MENU STRUCTURE

The SETUP MENU is configured as follows:

### 1. INFORMATION

1. Outgoing
2. Incoming Log
3. Speed Dial
4. Directory Dial
5. Forward Set
4. Alarm Reminder

## NAVIGATING THE MENUS

When programming within various menu options, information can be entered via the dial pad keys using [0]-[9] and [\*] dial keys, as well as utilizing the navigation button assembly.

The button used for editing and their features are summarized below.

<b>BUTTON</b>	<b>FEATURES</b>
Left and Right .....	To move a cursor (highlighted area) or to erase what is entered.
Enter .....	To save the current setting and end programming.
End.....	To cancel the current programming and return to the Main Menu.
Cancel.....	To move back to the previous screen or delete the last digit of the displayed option value.
[0]-[9] .....	To enter numerical values.

NOTE: The DS5007S keysets do not support the navigation key function.

# OUTSIDE CALLS

## MAKING AN OUTSIDE CALL

- Lift the handset and press an idle outside line button, line group button or dial a line access code to receive dial tone—**OR**—press an idle outside line button, line group button or dial a line access code to receive dial tone through the speaker—**OR**—press **SPEAKER**, receive intercom dial tone and dial a line access code.
- Dial the telephone number.
- Finish the call by replacing the handset or pressing the **END** button.

NOTE: You will receive No More Calls tone when you attempt to make a call and there is no button available for that line.

- If Least Cost Routing is enabled on your phone system, this button may be labeled **LCR** or accessed by dialing an access code (usually **9**).
- If your system is programmed to require an authorization code before making a call, dial \* plus a valid code before selecting a C.O. line.
- If your system is programmed to require an account code before making a call, press the **ACC** button or dial **47** plus a valid bin number, press the **ACC** button again, or \*, and then select a C.O. line. [See Account Codes for more information.](#)

For more information on authorization and account codes, see your system administrator.

NOTE: If the Hot Keypad feature has been turned off, you must first lift the handset or press the **SPEAKER** button before dialing.

## ANSWERING AN OUTSIDE CALL

- Lift the handset and you are automatically connected to the ringing call. [See Ring Preference under Customizing Your Keypad](#)—**OR**—press the **SEND** button to automatically answer on the speakerphone.

NOTE: If a call is flashing at your keyset but not ringing, you must press the flashing button to answer.

## UNIVERSAL ANSWER

Outside lines may be programmed to ring a general alerting device. To answer calls ringing this device, dial **67** or press the **UA** button. This device can operate in any one of the six different ring plans.

NOTE: If the Hot Keypad feature has been turned off, you must first lift the handset or press the **SPEAKER** button before dialing.

## RECALL DIAL TONE

Press the **NEW** button to disconnect your existing call, wait for dial tone and then make a new call on the same line.

NOTE: If this button does not appear on your keyset, the **FLASH** button may be programmed to recall dial tone.

## SENDING A FLASH

While on an outside call, press the **FLASH** button to send a flash to the telephone company. This is required for some custom calling features or CENTREX use.

NOTE: Flash is not available on an ISDN circuit.

## BUSY LINE QUEUING WITH CALLBACK

If you receive a busy signal when you are selecting an outside line, this means that the line or group of lines is busy.

- Press the **CBK** button, if programmed, or dial **44**. You will hear confirmation tone.
- When the line becomes free, the system will call you back.
- Lift the handset or press the **SEND** button to answer, wait for dial tone and dial the telephone number or speed dial number again.

NOTES:

1. A callback will be canceled if not answered within 30 seconds. If you have set a callback, your **CBK** button will light.
2. If the Hot Keypad feature has been turned off, you must first lift the handset or press the **SPEAKER** button before dialing.

## CANCELING CALLBACK

A callback will be canceled if not answered within 30 seconds. If you have set a callback, your **CBK** button will light.

Your phone may have a maximum of five callbacks to lines and/or stations set at a time. To cancel a callback:

- Press the **CBK** button, if programmed, or dial **44**. You will hear confirmation tone.
- While you are listening to confirmation tone, press the **HOLD** button. This will cancel the oldest set callback.

NOTE: If the hot keypad feature is turned off, you must first lift the handset or press the **SPEAKER** button before dialing.

# INTERCOM CALLS

## CALLING OTHER STATIONS

- Dial the extension number or group number.
- Wait for the party to answer. If you hear a brief tone burst instead of ringback tone, the station you called is set for Voice Announce or Auto Answer. Begin speaking immediately after the tone.
- Finish the call by replacing the handset or press the **END** button.

NOTES:

1. If you have a **DSS** button assigned to an extension or station group, you may press this button instead of dialing the number.
2. If the Hot Keypad feature has been turned off, you must first lift the handset or press the **SPEAKER** button before you begin dialing.

## ANSWERING INTERCOM CALLS

- When your keyset rings, simply lift the handset—**OR**—press the **SEND** button to be connected to the calling station.
- To finish the call, replace the handset or press the **END** button.

[See Ring Preference under Customizing Your Keyset.](#)

## VOICE ANNOUNCE MODE

When another station calls you, your keyset will sound a brief attention tone and you will hear the caller's announcement.

- Press **SEND** to turn on the microphone and speak handsfree—**OR**— lift the handset to reply.
- To finish the call, replace the handset or press the **END** button.

NOTE: In order for C.O. calls to be answered handsfree, AUTO ANS CO must be set ON.

## AUTO ANSWER MODE

When another station calls you, your keyset will sound a brief attention tone and then automatically answer the call.

- Your microphone and speaker are turned on and you can speak handsfree. For privacy, use the handset.
- To finish the call, replace the handset or press the **END** button.

NOTE: In order for C.O. calls to be answered handsfree, AUTO ANS CO must be set ON.

## BUSY STATION CALLBACK

When you call another station and receive a busy signal:

- Press the **CBK** button, if programmed, or dial **44**.
- When the busy station becomes free, your keyset will ring.
- Lift the handset or press **SEND** to call the now idle station.

NOTES:

1. A callback will be canceled if not answered within 30 seconds. If you have set a callback, your **CBK** button will light.
2. If the Hot Keypad feature has been turned off, you must first lift the handset or press the **SPEAKER** button before dialing.

## BUSY STATION CAMP-ON

When you call another station and receive a busy signal but you do not want to wait for a callback:

### MANUAL CAMP-ON

- Press the **CAMP** button or dial **45**.
- The called station will receive off-hook ring tone repeated every few seconds and its first available **CALL** button will flash green to indicate your call is waiting.
- Wait for the called party to answer.
- The called station must release its first call or place it on hold before answering your camp-on.

NOTES:

1. If you receive No More Calls tone, that station has no available button to accept your call. Hang up or leave a message.
2. If the Hot Keypad feature has been turned off, you must first lift the handset or press the **SPEAKER** button before dialing.

### AUTO CAMP-ON

When you want to automatically camp on to a busy station without pressing the camp on button every time you call a busy station, you can set your phone for auto camp-on.

- With the handset on-hook, press **TRANSFER** and then dial **110**.
- Dial **081** to turn on auto camp-on or **080** to turn it off.
- Press **TRANSFER** to store your selection.

## CALLING YOUR SYSTEM OPERATOR

- Dial **0** to call your system operator or group of operators.
- If you want to call a specific operator, dial that person's extension number.

NOTE: If the Hot Keypad feature has been turned off, you must first lift the handset or press the **SPEAKER** button before you begin dialing.

# CALL PROCESSING

## SYSTEM HOLD

- When you are connected to any call, press **HOLD**. The call will flash green at your keyset. If this call appears on a line button at other keysets, it will flash red at those keysets.
- To take the caller off hold, press that button and the green flashing light will go steady green again. Resume the conversation.

NOTE: While on a call, pressing a line button, route button or flashing **CALL** button will automatically put your first call on hold and connect you to the new call. [See Automatic Hold under Customizing Your Keyset.](#)

## EXCLUSIVE HOLD

To place an outside call on hold at your phone so that other users cannot get it:

- Press the **HOLD** button twice. The call will flash green on your keyset and this line will show a steady red light on other keysets.
- To retrieve the call, press the flashing green line button or press the **HOLD** button a third time.

NOTE: Intercom calls will always be placed on exclusive hold.

## REMOTE HOLD

When you wish to place a call on hold at another station. Press **TRANSFER** and dial the station number (or press the appropriate DSS button). Press the **HOLD** button. This will place the call on system hold on an available CALL button or Line Button at the remote station and return you to dial tone.

NOTES:

1. If the destination station does not have any free CALL buttons or line buttons you will hear No More Calls tone and must return to the other party by pressing the **TRANSFER** button (or the RETURN soft key in the display).
2. Intercom calls cannot be remote held.

## HOLD RECALL

If you leave a call on hold longer than the hold timer, it will recall your station. The button that the call appears on will have a slow flashing amber light.

- When your phone rings, lift the handset or press the **SEND** button to answer the recall.

- If you do not answer this recall within a pre-programmed period of time, it will go to the system operator.

## CONSULTATION HOLD

When you are talking on an outside line and it is necessary to consult with another extension:

- Press the **TRANSFER** button; you will receive transfer dial tone. Your call is placed on transfer hold.
- Dial the extension number.
- Consult with the internal party.
- Press **TRANSFER** to return to the outside party or hang up to transfer the call.

NOTE: Repeatedly pressing the **TRANSFER** button will toggle between the outside party and internal extension. If necessary you may disconnect either one of the parties by pressing the **DROP** button.

## RETRIEVING CALLS HELD AT ANOTHER STATION

When a line is on hold and it appears on your keyset, press the line button with the red flashing light.

When a line is on hold and it does not appear on your keyset, dial **12** plus the line number or the extension number of the station that placed the call on hold.

NOTE: If the Hot Keypad feature has been turned off, you must first lift the handset or press the **SPEAKER** button before you begin dialing.

## TRANSFERRING CALLS

Transfer is used to send any call to another extension in one of two ways. You can do a screened transfer by informing the other extension who is calling or you can do a blind transfer without notification.

- While on a call, press the **TRANSFER** button and dial an extension number or group number. Your call is automatically put on transfer hold. **OR** Press a **DSS** button or station group button. Your call is automatically put on transfer hold.
- Hang up when you hear ringing (this is an unscreened or blind transfer). **OR** Wait for the called party to answer and advise him/her of the call and hang up. If the transfer is refused, you will be reconnected to the outside line when the called station hangs up or you can press **TRANSFER** to return to the outside party. If you wish to send the call to another extension without waiting for the



first station to hang up, simply press another **DSS** button. **OR**  
Press the **CALL** button or C.O. line button to return to the outside party and begin the transfer process again.

When you are transferring a call to a keyset set for Voice Announce or Auto Answer, the transferred call will always ring.

#### NOTES:

1. After the inside party answers, you may alternate back and forth between the parties by pressing the **TRANSFER** button.
2. If you receive No More Calls tone, that station has no button available to receive another call. Press **TRANSFER** to return to the other party.
3. You cannot transfer an Intercom call by pressing a DSS button. You must press the **TRANSFER** button and dial the destination extension number.

## TRANSFER WITH CAMP-ON

When you are transferring a call to another station and you receive a busy signal, you may camp the call on to this station. Simply hang up when you hear the busy signal. The called party will be alerted that a call is waiting for them.

NOTE: If you receive No More Calls tone, that station has no button available to receive another call. Press **TRANSFER** to return to the outside caller.

## TRANSFER TO VOICEMAIL

This feature is used to send a call directly to a voice mailbox. Your keyset must have a correctly programmed **VT** button to accomplish this. To transfer a call directly to a voice mailbox:

- While on a call, press the **VT** button and dial the mailbox number.
- Hang up when dialing is completed.

## CALL WAITING

If an outside call has been camped-on to your phone or another station has camped-on to you:

- You will hear a tone in the earpiece and the call that is waiting for you (camped-on) will flash. In addition the bottom line of the display will indicate the number of the station or trunk party camped-on.
- Press the flashing button to answer; your other call will go on hold automatically if your station has the Automatic Hold feature set. If not, you must press **HOLD** and then the flashing button **OR** Finish the first call and hang up; the waiting call will ring.

- Lift the handset or press the **SEND** button to answer.

NOTE: Intercom calls will not go on Automatic Hold.

## CONFERENCE CALLS

You may conference up to five parties (you and four others) in any combination of outside lines and internal stations in any order.

- While engaged in a conversation, press the **CONF** button and receive conference tone.
- Make another call, either intercom or outside, press the **CONF** button and receive conference tone.
- Make another call or press the **CONF** button to join all parties.
- Repeat the last step until all parties are added.

NOTE: When attempting to add another party to the conference and you are not able to reach the desired person, hang up. Simply press the **CONF** button again to return to your previous conversation.

#### To drop a party from your conference call:

- Press **CONF** and dial the extension or line number that is to be dropped.
- Press **CONF** again to reestablish the conference.

NOTE: To leave the conference, hang up. Control is passed to the next internal station. If there are no internal stations and you wish to leave outside lines connected together in a trunk to trunk conference, press the **CONF** button plus the **CALL** button that the call appears on or follow the instructions to drop a party and use your extension number. When they hang up, the lines will release automatically. Press **CONF** to rejoin a trunk to trunk conference.

## CONFERENCE SPLITTING

If you are the controlling party of a conference and your keyset has the Auto Hold feature turned on ([See Customizing Your Keyset](#)) and all of the outside lines involved in the conference appear as buttons on your keyset, you can split the conference into separate calls as follows:

- Press any one of the outside line buttons. That outside line will remain steady green to indicate you are still connected to it. All other outside lines in the conference will be placed on system hold at your keyset. All intercom callers in the conference will be disconnected. You may now speak with each caller privately and transfer them as usual or reestablish another conference.

## FORWARDING CALLS

You may forward your calls to another station, group of stations or an external telephone number. Program a destination for the type of forwarding you want as detailed below. If you have **FWD ALL**, **FWD BUSY** and **FWD NO ANSWER** buttons, press one to turn that forward feature on. A steady red light reminds you what forward condition is activated.

You can clear all call forward conditions set at your station by lifting the handset and dialing **600**.

### FORWARD ALL CALLS

To forward all your calls under any condition to another station:

- Dial **601** plus the extension or group number.
- Receive confirmation tone and hang up.

#### NOTES:

1. If the Hot Keypad feature has been turned off, you must first lift the handset or press the **SPEAKER** button before you begin dialing.
2. The station that receives a Forwarded All call can transfer the call to the forwarded station. This is useful when you are expecting an important call but you do not wish to be disturbed by other calls.
3. When a station user places his/her keyset in Forward All mode and he/she does not have a **FORWARD ALL** button, the **TRANSFER** button will light to indicate Forward All has been set and calls to this station have been transferred elsewhere.

### FORWARD BUSY

To forward calls to another station when you are on the phone:

- Dial **602** plus the extension or group number.
- Receive confirmation tone and hang up.

NOTE: If the Hot Keypad feature has been turned off, you must first lift the handset or press **SPEAKER** before you begin dialing.

### FORWARD NO ANSWER

To forward calls to another station when you do not answer:

- Dial **603** plus the extension or group number.
- Receive confirmation tone and hang up.

NOTE: If the Hot Keypad feature has been turned off, you must first lift the handset or press the **SPEAKER** button before you begin dialing.

## FORWARD BUSY/NO ANSWER

If you have both a Forward on Busy destination and a Forward No Answer destination programmed, you may set both of these at the same time:

- Dial **604**.
- Receive confirmation tone and hang up.

NOTE: If the Hot Keypad feature has been turned off, you must first lift the handset or press the **SPEAKER** button before you begin dialing.

### FORWARD FOLLOW ME

When you want all calls to your extension forwarded to the extension where you are now:

- Dial **606** plus your extension number.
- Receive confirmation tone and hang up.

If you want a specific extension's calls forwarded to your phone (Remote Call Forward):

- Dial **606** plus the desired extension number.
- Receive confirmation tone and hang up.

NOTE: If the Hot Keypad feature has been turned off, you must first lift the handset or press the **SPEAKER** button before you begin dialing.

### FORWARD DND

To forward your phone when you activate DND.

- Dial **605** plus the extension number or group number.
- Receive confirmation tone and hang up.

NOTE: If the Hot Keypad feature has been turned off you must first lift the handset or press the **SPEAKER** button before you begin dialing.

## CALL FORWARD OPTIONS

A display keyset may review or change call forward options and destinations. Call forward access can be done via the keypad or by accessing the keyset display features. To review or change call forward options:

- Press **TRANSFER 102**.  
The display will indicate the current call forward condition and destination  
**OR**  
Show **0:FORWARD CANCEL** to indicate no forward is set.

- Dial **0** to cancel current condition **OR**  
Dial **1-5** to select the forward type **OR**  
Press **UP** or **DOWN** to select the forward type.  
Press the right soft key to move the cursor.
- Dial the destination number (e.g., **202**) **OR**  
Press **UP** or **DOWN** to select the destination  
Press the right soft key to move the cursor
- Dial **1** to set **OR**  
Press **UP** or **DOWN** to select **YES** or **NO**
- Press **TRANSFER** to store and exit

## STATION CALL PICKUP

To pick up (answer) a call ringing at another station, lift the handset and dial **65** plus the extension number of the ringing phone.

If you have a **DP** key assigned with a station number, you only need to press this **DP** key with the flashing light to answer this ringing station.

NOTE: If the Hot Keypad feature has been turned off, you must first lift the handset or press the **SPEAKER** button before you begin dialing.

## GROUP CALL PICKUP

To pick up (answer) a call ringing in any pickup group, lift the handset and dial **66** plus the desired **group number** or press the flashing **GROUP PICKUP** button if available.

### GROUP NUMBERS

<b>01-10</b>	<b>OfficeServ 7030</b>
<b>01-20</b>	<b>OfficeServ 100, OfficeServ 7100 and OfficeServ 7200-S</b>
<b>01-99</b>	<b>OfficeServ 500 M</b>
<b>01-99</b>	<b>OfficeServ 500 L</b>
<b>01-99</b>	<b>OfficeServ 7200 and OfficeServ 7400</b>

### NOTES:

1. A group pickup button can have an extender for a specific pickup group.
2. If the Hot Keypad feature has been turned off, you must first lift the handset or press the **SPEAKER** button before dialing the access code.

## MY GROUP PICKUP

If desired, a new access code can be assigned to pickup ringing calls in the same pickup group as you are in. Like "66" above except you do not need to dial the desired group number. See your installation company for the assigned access code. MY GROUP PICKUP: \_\_\_\_\_.

## PRIVACY RELEASE

This feature will allow another station to join in our conversation by releasing privacy on the C.O. from your phone.

### To Release Privacy:

While you are talking on a C.O. line and you wish to have other internal parties (or up to three) join the conversation.

- Press the **PRB** button (the **PRB** button will light steady red). Inform the other party that he/she may now join the conversation.

After the other party (or parties) has joined the conversation and you wish to return privacy to the line so that no one else can join the conversation, press the **PRB** button a second time, the **PRB** button will be off.

### To Join a Non-Private Conversation:

When someone has informed you that you can join a conversation:

- Press the **C.O. line** button that he/she has indicated.  
OR
- Dial the **C.O. line number** that he/she has indicated.

# DIALING FEATURES

All "DIALING FEATURES" instructions are written to support Overlap Dialing mode. This is the technical name for dialing from a telephone as it has been for many years. In recent years the cell phone industry has changed the cell phones to use Enblock Dialing. With this dialing mode all the digits are dialed and then sent to the carrier after pressing the SEND key. Please check your telephone setup to confirm what dialing mode is used.

## SPEED DIALING

You can dial a preprogrammed telephone number stored in the system-wide speed dial list of numbers 500~999 or from your personal list of numbers 00~49.

Your system may be set for 950 system wide numbers. If so the system speed dial access codes are 050~999 and the station speed dial codes are 000~049.

- With the handset on-hook, press the **MEMORY** button or dial **16**.
- Dial the desired speed dial number.
- The telephone number is automatically dialed for you.

NOTE: If the Hot Keypad feature has been turned off, you must first lift the handset or press the **SPEAKER** button before you begin dialing.

## PROGRAMMING PERSONAL SPEED DIAL NUMBERS

You can program frequently dialed telephone numbers in a personal speed dial list. A station may be assigned up to fifty numbers, **00-49**. See your system administrator to determine the amount assigned to your station.

- While on-hook, press **TRANSFER** and then dial **105**.
- Dial a speed dial number (**00-49**).
- Dial a line or line group access code.
- Dial the telephone number to be stored (24 digits maximum). It can include #, \*, FLASH and PAUSE.
- Press **TRANSFER** to store the number.

NOTE: If the Hot Keypad feature has been turned off, you must first lift the handset or press the **SPEAKER** button before you begin dialing.

For the purposes of programming speed dial numbers, the programmable buttons are known as **A, B, C, D, E** and **F**.

- The **A** button is not used.
- The **B** button inserts a flash.
- The **C** button inserts a pause.
- The **D** button is used for pulse to tone conversion. If your system uses rotary (or pulse) dialing C.O. lines, pressing **D** while entering a speed dial number causes all subsequent digits to be sent as DTMF tones.
- The **E** button is used to hide digits. Display keyset users may want to hide some speed dial numbers so that they will not show in the display. When you are entering a telephone number, press **E**. All subsequent digits will be hidden. Press **E** again to begin displaying digits.
- The **F** button is used to enter a name. [See Personal Speed Dial Names under Display Features.](#)
- Use the **HOLD** button to clear a speed dial number.

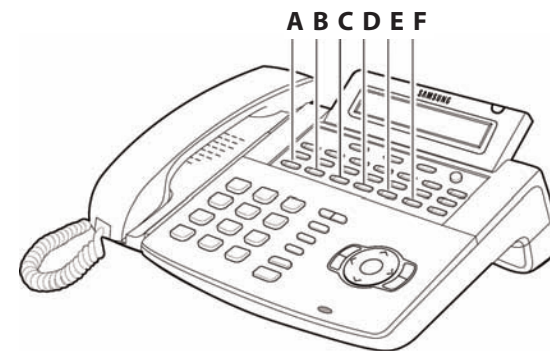

## ONE TOUCH SPEED DIALING

You may assign any speed dial number to an already existing One Touch Speed Dial button for quick and easy dialing of frequently used numbers.

- While on-hook, press **TRANSFER** and then dial **107**.
- Press a One Touch Speed Dial button.
- Dial the speed dial number (**00-49** or **500-999**) that you want assigned to this button.
- Press **TRANSFER** to store your selection.

To call this telephone number, just press the One Touch Speed Dial button.

NOTE: If the Hot Keypad feature has been turned off, you must first lift the handset or press the **SPEAKER** button before you begin dialing.

## LAST NUMBER REDIAL

To redial the last telephone number you dialed, press the **REDIAL** button or dial **19**.

NOTES:

1. If the Hot Keypad feature has been turned off, you must first lift the handset or press the **SPEAKER** button before you begin dialing.
2. Redial does not apply to intercom calls.

## MANUAL RETRY WITH REDIAL

While you are on an outside call listening to a busy signal and you want to redial the same number dialed.

- Press the **REDIAL** button.

This will hang up your existing call and manually redial the same number dialed. You can repeat this operation for a limited number of attempts.

NOTE: If your keyset is programmed with Call Log Blocks then the Redial will access the call log when pressed.

## SAVE NUMBER WITH REDIAL

To save the number you just dialed for later use, press the **SNR** button before hanging up.

To redial this saved number at any time, press the **SNR** button or dial **17**. The same line will be selected for you.

NOTES:

1. If the Hot Keypad feature has been turned off, you must first lift the handset or press the **SPEAKER** button before you begin dialing.
2. The saved telephone number is stored in memory until you save another number.
3. Redial does not apply to intercom calls.

## CHAIN DIALING

You may manually dial additional digits following a speed dial number or chain as many speed dial numbers together as required:

- After the first speed number is dialed, press **MEMORY** again and dial another speed number **OR** manually dial additional digits following a speed dial number.

## AUTOMATIC REDIAL/RETRY

When you are making an outside call and you receive a busy signal, the system can automatically redial the number for you. It will automatically redial at a pre-programmed interval for up to 15 attempts.

- When you hear a busy signal, press the **RETRY** button.
- The system will reserve the line and automatically redial the same number for you. You will hear the call being made through the keyset speaker. The microphone is muted.

- When the called party answers, lift the handset or press the flashing **SPEAKER** to begin speaking.

NOTES:

1. If you make another call, auto-redial is canceled.
2. To cancel a retry, lift and replace the handset.

## PULSE TO TONE CHANGEOVER

When making an outside call on a dial pulse line, press **#**. All digits dialed after the **#** will be sent as tones.

## MEMO REDIALING

When you are calling directory information, you can store the number you are given using the **SAVE** feature. There is no need for pencil and paper.

- While you are talking on an outside call, press **SAVE**.
- Dial the telephone number as it is dictated to you on the keypad.
- Press **SAVE** to store the number.

To dial the number, press the **SNR** button. It will select the same line and dial the stored number. If necessary, you can select a different line and then press the **SNR** button.

# PAGING AND MESSAGING

## MAKING AN INTERNAL PAGE

To make an announcement through the keyset speakers in the idle condition:

- Lift the handset.
- Press the **PAGE** button or dial **55**.
- Dial the desired zone number **0, 1, 2, 3** or **4**.
- After the attention tone, make your announcement.

### NOTES

1. If you have a dedicated page zone button, it is not necessary to press **PAGE** and dial a zone number.
2. If allowed by your system administrator you may be able to initiate a page from a speakerphone by pressing the **PAGE** key or dialing **55** without lifting the handset.

## MAKING AN EXTERNAL PAGE

To make an announcement through the external paging speakers:

- Lift the handset.
- Press the **PAGE** button or dial **55**.
- Dial the desired zone number **5, 6, 7** or **8** or dial **9** to page all external zones.
- After the attention tone, make your announcement.

### NOTES

1. If you have a dedicated page zone button, it is not necessary to press **PAGE** and dial a zone number.
2. If allowed by your system administrator you may be able to initiate a page from a speakerphone by pressing the **PAGE** key or dialing **55** without lifting the handset.

## ALL PAGE

To page all designated keysets in internal zone 0 and all external zones at the same time:

- Lift the handset.
- Press the **PAGE** button or dial **55**.
- Dial **\*** or press the **ALL PAGE** button.
- After the attention tone, make your announcement.

### NOTES

1. The LED on the **PAGE** button will only light when an All Page is in progress.

2. If allowed by your system administrator you may be able to initiate a page from a speakerphone by pressing the **PAGE** key or dialing **55** without lifting the handset.

## MEET ME PAGE

- Lift the handset.
- Press the Meet Me Page (**MMPG**) button or dial **54**.
- Dial the desired zone number.
- After the attention tone, instruct the paged person to dial **56**.
- Press **WAIT** or **TRANSFER**.
- Remain off-hook until the person dials **56** from any phone.
- The paged person will be automatically connected with you.

## CALL PARK AND PAGE

When you have an outside call for someone who is not at his/her desk, you can park the call prior to paging. The system offers two different methods:

### MANUAL PARK ORBITS

- While in conversation, press the **PARK** button.
- Entered a desired orbit number (**0-9**), if the orbit number is busy dial another orbit number. Display users can press **\*** to automatically place the call in any available orbit number and see the number in the display.
- Remember the selected orbit number.
- Replace the handset when finished.
- Lift the handset and make a page announcement as previously described (example: "John Smith park two").

### To retrieve a parked call from orbit:

- Press the **PARK** button and dial the announced orbit number (**0-9**).
- You will be connected to the parked call.

### NOTES:

1. You must have a **PARK** button or park access code to retrieve and place calls in park orbits.
2. If the parked call is not retrieved within a pre-programmed period of time, it will recall your keyset and have a slow flashing amber light. You cannot park and page intercom calls.
3. If the Hot Keypad feature has been turned off, you must first lift the handset or press the **SPEAKER** button before you begin dialing.

### AUTOMATIC PARK WITH PAGE BUTTON

- While in conversation, press the **PAGE** button. The call is automatically parked at your station.

- Receive page tone and dial a desired page zone number.
- Make announcement indicating your extension number or the line number. Hang up.

#### To retrieve an automatically parked call:

- Dial **10** plus the number that was announced. If you have a **PAGPK** button, press it and dial the number that was announced. If you have a **PARK** button, press it and dial the announced orbit number.
- You will be connected to the parked call.

#### NOTES:

1. If the call is not retrieved within a pre-programmed period of time, it will recall your keyset and have a slow flashing amber light. You cannot park and page intercom calls.
2. If the Hot Keypad feature has been turned off, you must first lift the handset or press the **SPEAKER** button before you begin dialing.

## SETTING A MESSAGE INDICATION

When you are calling another station and no one answers or you receive a busy signal, you can leave a message indication:

- Press the **MESSAGE** button or dial **43** and receive confirmation tone.
- Hang up. The **MESSAGE** button on the called station will light. Standard telephones receive special dial tone as a message indication or a lit message lamp, if the phone is equipped with one and they are connected to an 8MWSLI card (not available on the OfficeServ 100 or OfficeServ 7000 Series) or a 16MWSLI card on the system.

#### NOTES:

1. A station can have up to five message indications.
2. If the Hot Keypad feature has been turned off, you must first lift the handset or press the **SPEAKER** button before you begin dialing.

## CANCELING MESSAGES

To cancel a message indication that you left at another station, dial **42** plus the extension number of the station at which you left a message. To cancel all message indications left at your keyset, dial **42** plus your extension. Your **MESSAGE** light will go out.

NOTE: If the Hot Keypad feature has been turned off, you must first lift the handset or press the **SPEAKER** button before you begin dialing.

## RETURNING MESSAGES

- Press the **MESSAGE** button or dial **43**. The first station that left a message will be called automatically. If that station does not answer, your **MESSAGE** light will stay on.
- Repeat until all messages have been returned in the order received.
- Your **MESSAGE** light will turn off when all messages have been returned.

#### NOTES:

1. Display keyset users can view message indications and return them in any order. [See Viewing Message Indications under Display Features.](#)
2. If the Hot Keypad feature has been turned off, you must first lift the handset or press the **SPEAKER** button before you begin dialing.
3. If a message has been left at your keyset by a keyset in Auto Answer, you must manually cancel the message after it has been returned.

## PROGRAMMED MESSAGES

When you will be away from your phone for any length of time, you can leave a programmed station message. Display stations calling you will see this message and be informed of your status or follow your instructions.

- Dial **48** plus any of the message codes (**01–20**) listed on the back of this user guide.
- To cancel any of these messages you might have selected, dial **48** plus **00**.
- Press **TRANSFER** to exit and store your selection.

NOTE: If the Hot Keypad feature has been turned off, you must first lift the handset or press the **SPEAKER** button.

You can have multiple programmed message buttons (**PMSG**) and each one can have a different message code:

- Press any programmed message (**PMSG**) button. The message is set and the button will light red. Press the button again to turn off.
- Pressing another programmed message (**PMSG**) button will turn the previous one off and set a different programmed message.

# CONVENIENCE FEATURES

## DO NOT DISTURB

Use this feature when you want to block calls to your keyset.

- While on-hook, press the **DND** button or dial **401**. The **DND** button lights steady red to remind you of this mode.
- To cancel DND, press the **DND** button again or dial **400**. The **DND** light turns off. You can make calls while in the DND mode.

NOTES:

1. If the Hot Keypad feature has been turned off, you must first lift the handset or press the **SPEAKER** button.
2. If you place your keyset in DND mode and you do not have a **DND** button, your **TSI** button will flash to indicate DND status.

## ONE TIME DND

If you are on a call and you do not wish to be interrupted while on that call, you can press the **DND** button and place your station in Do Not Disturb. When you hang up at the end of the call, DND will be automatically canceled and your keyset will be able to receive new calls. This feature requires a **DND** button.

## MUTE

You can mute the handset transmitter or the microphone during any conversation:

- Press the **MUTE** button. It will light red.
- To resume speaking, press the **MUTE** button again. The light turns off.

## BACKGROUND MUSIC

When a music source is supplied, you may listen to music through the speaker in your keyset:

- While on-hook, press the **HOLD** button to hear music.
- Press the **HOLD** button again to turn music off.

You can set the level of background music by using the **VOLUME** buttons while listening to the music. This does not affect the speakerphone level.

## ESTABLISHED CALL PICKUP

To pick up an established call in progress at a single line extension connected to a computer modem on your PC.

- Press the **EP** button for that station on your keyset and the call is automatically moved to your keyset.
- The single line extension on your modem will be disconnected.

NOTE: You must have an assigned (EP button) button on your regular keyset, for the single line station.

## APPOINTMENT REMINDER/ALARM CLOCK

This feature works like an alarm clock. Use it to remind yourself of an appointment later in the day (TODAY ONLY) or as a daily reminder every day (DAILY). You can set up to three alarms. Each one can be either a TODAY ONLY or a DAILY alarm.

When the alarm rings, you will hear three short rings repeated three times. Lift the handset to answer the alarm. If you do not, the alarm will alert you two more times at five minute intervals.

To set alarms:

- Press **TRANSFER** and then dial **112**.
- Dial the alarm number **1**, **2** or **3**.
- Dial the time at which you want the alarm to sound. Enter the time as HHMM (hours and minutes) using the 24 hour clock.
- Dial **0** (NOT SET), **1** (TODAY ONLY) or **2** (DAILY) to select the alarm type.
- Press **TRANSFER** to save.
- Repeat for each alarm if needed.

To cancel individual alarms:

- Press **TRANSFER** and then dial **112**.
- Dial alarm number **1**, **2** or **3**.
- Press the **HOLD** button.

NOTE: Display keysets can show a reminder message. [See Alarm Reminder Messages under Display Features.](#)



## ANSWERING THE DOOR PHONE

When you are programmed to receive calls from a door phone:

- You will receive three short rings repeated.
- Lift the handset or press **SEND** button. You are connected to the door phone.
- If an electric door lock release is installed, dial **13** to unlock the door.

## CALLING THE DOOR PHONE/ ROOM MONITOR

You may call the door phone and listen to what may be happening outside or in another room.

- Dial the extension number of the door phone.
- You will be connected to the door phone and you can listen or have a conversation.
- If an electric door lock release is installed, dial **13** to unlock the door.

NOTE: If the Hot Keypad feature has been turned off, you must first lift the handset or press the **SPEAKER** button.

## EXECUTIVE/SECRETARY HOT LINE

If programmed, an executive and a secretary can have a hot line between them. When the executive station is in the DND mode, all of its calls will ring the secretary station. If the secretary does not answer, the caller will go to the secretary's voicemail box if setup.

- Either person can press the **BOSS** button to make a voice call to the other station.
- Using the hot line will override DND at the other station. This button will light red when the other station is in use.

### To transfer a call to a Boss in DND:

- Press the **TRANSFER** button followed by the **BOSS** button.
- Wait for the **BOSS** to answer, then announce the call and hang up to complete the transfer **OR**
- Hang up to complete a blind transfer after pressing the **BOSS** button.

## EXECUTIVE DIVERT

When the executive station is in the **DIVERT** mode all of his/her calls will ring the secretary station.

- Press the **DIVERT** button to pass a call while ringing.

### To transfer all calls to the Secretary:

- Press the **DIVERT** button while the phone is idle. The LED will be lit and all calls will ring the secretary.

The secretary can call the **BOSS** in the **DIVERT** mode but all other users will ring the secretary (the secretary can override the boss' **DIVERT**).

## GROUP LISTENING

When you are engaged on a call and you are using the handset, you may want other people to hear the distant party's voice over the speaker:

- Press the **LISTEN** button to turn on the speaker. The microphone is not in use, so the distant party does not hear other parties present in your office.
- Press **LISTEN** again to turn the speaker off and resume private conversation.
- Repeat if necessary.

NOTE: Depending on speaker volume and the acoustics of your office, it may be advisable to turn the group listening feature off before hanging up. This will eliminate a momentary squeal.

## ACCOUNT CODES

When enabled, your system allows calls to be charged to different accounts. You can enter account codes either by dialing the full code, by entering an account code "bin number", or by pressing your **ACC** key if one is assigned. Bin numbers are a 3 digit short code that will automatically insert the appropriate account code. Account codes may be a maximum of 12 digits (# may be used); if the account code is to be less than 12 characters you may end the code by pressing **\*** or the right soft key. The type of code used is determined by your telephone system administrator. Codes can be entered before or during a call as follows:

To enter an account code before placing the call:

- Press your **ACC** key or dial **47**.
- Dial the account code or bin number.
- You will receive a confirmation tone and display.
- When prompted dial a trunk or trunk group (i.e. 9) and the telephone number to call.

To enter an account code by interrupting the conversation:

- While on an outside call press the **ACC** key or press **TRANSFER** followed by **47**.
- Dial the account number or bin number (if you are entering an account code you will need to press your **ACC** key or right soft key to finalize the entry)

NOTE: If you make an error simply repeat the procedure with the correct code. Only the most recent account code dialed will be recorded.

## LOCKING YOUR KEYSSET

You can lock your keyset to control misuse of your phone while you are away. You can unlock it when you return. Your default station passcode is 1234.

	0 UNLOCKED	1 LOCKED OUTGOING Hold Button LED Flashes	2 LOCKED ALL CALLS Hold Button LED Solid
Make outside calls	YES	NO-ACCESS DENIED	NO
Receive outside calls	YES	YES	NO
Make intercom calls	YES	YES	NO
Receive intercom calls	YES	YES	NO
Make 911 calls	YES	YES*	NO

- While on-hook, press **TRANSFER** and then dial **100**.
- Dial your four digit station passcode.
- Dial **1** to locking outgoing, **2** for locked all calls, or **0** to unlock.
- Press **TRANSFER** to store your selection.

Note\*: When 911 is programmed, 911 emergency dialing is allowed for a LOCKED OUTGOING station.

## MANUAL SIGNALLING

Use this feature when you want to send a brief 500ms ring burst to another station, regardless of the status of your phone (on-hook, off-hook, handsfree, DND, or ringing).

### To send a signal to another station:

- Press the Manual Signalling (**MS**) button.
- You may press the **MS** button repeatedly to send multiple signals to the designated station.

**NOTE: Your phone must have a Manual Signalling (MS) button with a station number extender assigned to it.**

## OFF-HOOK VOICE ANNOUNCE

Keysets may receive a voice announcement while on another call. The calling station must have an **OHVA** button. When you are in DND, you cannot receive OHVA calls. The OHVA feature will work with intercom and transferred calls.

When you receive an OHVA and secure OHVA is ON, you will hear the announcement in the handset receiver, if you are using the handset. If secure OHVA is OFF

then you will hear the announcement on the speaker, if you are talking on the handset. If you are using the speakerphone the announcement will always be heard through the speaker.

### To make an off-hook voice announcement:

- Dial the extension number or press the **DSS** button.
- When you receive a busy signal, press the **OHVA** button.
- After the attention tone, begin speaking.
- Finish the call by replacing the handset.
- Press the flashing **CALL** button on your keyset. This will place the original party on hold and allow you to talk to the announcing party.
- To return to your first party, press the button corresponding to your original call. This will disconnect the OHVA call.

### NOTES:

1. When you are voice announcing to a station close to you, use the handset to avoid an echo effect.
2. You cannot off-hook voice announce to single line telephones.

## OHVA BLOCK

Your keyset can be programmed with an OHVA Block (**BLOCK**) button. Pressing this button will prevent anyone from making an OHVA to you until you press the button again and cancel the blocking.

## OHVA REJECT

Your keyset can be programmed with an OHVA Reject (**REJECT**) button. Pressing this button while receiving an OHVA call will disconnect the voice announcing party and return you to your original call.

## IN GROUP/OUT OF GROUP

If your keyset is assigned to a station ring group, you can remove your keyset from the group and then put it back in. While you are out of the group, you can receive calls to your extension number but not calls to the group number. If you have an **IN/OUT** button with the group number assigned.

- Press the **IN/OUT** button. It will light red when your keyset is in the group.
- Press the **IN/OUT** button again to exit the group and turn the light off. Repeat as necessary.

If you do not have an **IN/OUT** button:

- Dial the **IN/OUT** access code number \_\_\_\_\_, then the group number, then **0** to exit the group or **1** to enter the group.

NOTE: If the Hot Keypad feature has been turned off, you must first lift the handset or press **SPEAKER** button.

The **IN/OUT** button can include an extender to indicate the specific group that this button will affect. This means that if you are in multiple groups, you can decide for which groups you will receive calls.

## CUSTOMIZING YOUR KEYSSET

### AME PASSWORD

This feature allows customers using the AME feature to enable password protection. This will prevent unauthorized users from listening to your messages being left. The passcode is the same as your station passcode. This feature only applies if there is an Samsung Voicemail card installed in the system and your keyset has a programmed AME button.

- With the handset on-hook, press **TRANSFER** and then dial **110**.
- Dial **101** to turn on AME PASSCODE or **100** to turn it off.
- Press **TRANSFER** to store your selection.

### AUTO CAMP-ON

This option allows intercom calls to be automatically camped on, if possible, when a busy station is called.

- With the handset on-hook, press **TRANSFER** and then dial **110**.
- Press **081** to turn CAMP-ON on or **080** to turn it off.
- Press **TRANSFER** to store your selection.

### SELECT RING TONE

Each keyset user can select any one of eight ring frequencies:

- While on-hook, press **TRANSFER** and then dial **111**.
- Dial **1–8** or press the **UP** and **DOWN** buttons to hear each tone.
- When you hear the tone that you prefer, press **TRANSFER** to save it.

**NOTE: Specific lines or stations may be programmed to ring with a different tone than what you have selected for your keyset.**

### CHANGE YOUR PASSCODE

From the factory, your station passcode is 1234. You can change your station passcode whenever you desire.

- While on-hook, press **TRANSFER** and then dial **101**.
- Dial your old passcode.
- Dial a new passcode (must be four characters). You can use **0–9**.
- Redial the new passcode to verify. If successful, you will hear two beeps. Four beeps indicate an incorrect code. Reenter the code again.
- Press **TRANSFER** to store the new passcode.

## SET ANSWER MODE (INTERCOM)

You can receive internal calls in one of three modes ([see Answering Intercom Calls under Intercom Calls for descriptions](#)):

- While on-hook, press **TRANSFER** and then dial **103**.
- Dial **0** for Ringing, **1** for Auto Answer or **2** for Voice Announce.
- Press **TRANSFER** to store your selection.

## SET ANSWER MODE (CO)

Your incoming CO calls can be set to follow the intercom answer mode.

- While on-hook, press **TRANSFER** and then dial **110**
- Dial **15** to access **AUTO ANS CO**.
- Press the **VOLUME UP** or **DOWN** key to change status.
- Press **TRANSFER** to store your selection.

NOTE: When your keyset is programmed for Auto Answer and you have Forward No Answer (FNA) turned on, you must answer screened transfers by pressing the **SEND** button before your FNA timer expires or the call will forward.

## AUTOMATIC HOLD

While on an outside call, pressing a line button, route button or a flashing **CALL** button will automatically put your call on hold and connect you to the next call. This feature can be turned on or off at your keyset.

- With the handset on-hook, press **TRANSFER** and then dial **110**.
- Dial **001** to turn Automatic Hold on or **000** to turn it off.
- Press **TRANSFER** to store your selection.

NOTE: Intercom calls can be automatically put on hold by pressing **TRANSFER**.

## HEADSET OPERATION

Keyset users can switch between headset mode and handset mode. When using headset mode, press the **SEND/END** button to answer and release calls.

- With the handset on-hook, press **TRANSFER** and then dial **110**.
- Dial **021** to use the headset or **020** to use the handset.
- Press **TRANSFER** to store your selection.

Your keyset may be equipped with a Headset mode button. If it is so equipped pressing this button while the light is out will cause the keyset to enter headset mode and the light will illuminate to indicate this. Pressing the button while the light is lit will cause the keyset to return to handset mode and the light will go out.

## HOT KEYPAD

On your phone system your keyset's keypad can be made "live" or "hot" so that it is not necessary to lift the handset or press the **SPEAKER** button before you begin dialing. Calls can be made and features activated by simply dialing the C.O. line number, trunk group access code, intercom number or feature access code. To activate this feature:

- With the handset on-hook, press **TRANSFER** and then dial **110**.
- Dial **031** to turn the Hot Keypad on or **030** to turn it off.
- Press **TRANSFER** to store your selection.

## KEY CONFIRMATION TONE

You can hear a short beep (confirmation tone) each time you press a button on the dial pad. This tone can be turned on or off.

- While on-hook, press **TRANSFER** and then dial **110**.
- Dial **040** to turn tones off or **041** to turn tones on.
- Press **TRANSFER** to store your selection.

## REJOINING A PAGE

This feature allows you to hear the remaining portion of an ongoing internal page after you return your keyset to idle. To enable this feature:

- With the handset on-hook, press **TRANSFER** and then dial **110**.
- Dial **051** to turn this feature on or **050** to turn it off.
- Press **TRANSFER** to store your selection.

## RING PREFERENCE

This feature automatically answers ringing calls when you lift the handset or press the **SEND** button. This method will always answer calls in the order they arrived at your keyset. When you turn ring preference off, you must press the flashing button to answer a call, allowing you to answer calls in the order you choose.

- With the handset on-hook, press **TRANSFER** and then dial **110**.
- Dial **061** to turn ring preference on or **060** to turn it off.
- Press **TRANSFER** to store your selection.

## AUTO ANSWER CO CALLS

This option will allow CO calls that directly ring your phone to auto answer. When a CO call arrives at your station and this option set for ON your phone will sound two beeps, the same as when a screened transfer is completed, and you will be connected to the CO call. In order for this option to work the station must also be programmed for auto answer ([see SET ANSWER MODE](#)).

- While on hook, press **TRANSFER** and then dial **110**.
- Dial **151** to turn Auto Answer CO on or **150** to turn it off.
- Press **TRANSFER** to store your selection.

NOTE: Outside lines must ring your station directly for the Auto Answer CO to work. Lines ringing a station group will not cause your phone to Auto Answer.

## DISPLAY SPEED DIAL NAME

This option allows you to view the name associated with a speed dial number as it is dialed.

- With you handset on-hook, press **TRANSFER** and then dial **110**.
- Press **111** to turn **DISP SPDNAME** on or **110** to turn it off.
- Press **TRANSFER** to store your selection.

## CALLER ID REVIEW ALL

This feature allows display keyset users to review Caller ID information for calls sent to their stations. This list can be from ten to fifty calls in a first in, first out basis. The list includes calls that you answered and calls that rang your station but that you did not answer. When reviewing this list, you can press one button to dial the person back. The system must be using LCR to dial the stored number.

- With you handset on-hook, press **TRANSFER** and then dial **110**.
- Press **121** to turn **CID REVIEW ALL** on or **120** to turn it off.
- Press **TRANSFER** to store your selection.

## SECURE OHVA

This option allows you to receive OHVA calls via the speaker while you are on the handset.

- With you handset on-hook, press **TRANSFER** and then dial **110**.
- Press **131** to turn **AUTO CAMP-ON** on or **130** to turn it off.
- Press **TRANSFER** to store your selection.

## ENBLOCK DIALING

This option allows you to dial digits then press the **SEND** button to make the call (like a cellphone).

- While the handset on-hook press **TRANSFER** then dial **110**.
- Dial **161** to turn Enblock Dialing ON or **160** to turn it off.
- Press **TRANSFER** to store your selection.

## CONFIGURE MOBILE EXTENSIONS (MOBEX)

This feature allows you to configure options for any Mobile Extension (MOBEX) ports that are assigned to you by your telephone system administrator. You can turn a port on or off; set the telephone number for the port; or set the caller ID you will be calling in from. The caller ID field has no effect unless you have been authorized as an Executive MOBEX user. Check with your telephone system administrator for further details on your specific system configuration.

### To set the phone number a MOBEX port can reach you on:

- Press **TRANSFER** and then dial **126**.
- Dial your station pass code.
- Dial the number of the port you wish to configure (1-5) (you may also use the Volume Up and Volume Down keys to select a port and press the right soft key to confirm).
- Dial **0** to select the telephone option.
- Dial the number of a C.O. line to use when making calls to this MOBEX port.
- Dial the phone number you can be reached at by users calling this MOBEX port.
- Press **TRANSFER** to store your selection and exit programming.

### To set the caller ID of the location you will be calling in from:

- Press **TRANSFER** and then dial **126**.
- Dial your station pass code.
- Dial the number of the port you wish to configure (1-5) (you may also use the Volume Up and Volume Down keys to select a port and press the right soft key to confirm).
- Dial **1** to select the caller ID option.
- Dial the phone number you will be calling in from.
- Press **TRANSFER** to store your selection and exit programming.

### To turn a MOBEX port ON or OFF:

- Press **TRANSFER** and then dial **126**.
- Dial your station pass code.
- Dial the number of the port you wish to configure (1-5) (you may also use the Volume Up and Volume Down keys to select a port and press the right soft key to confirm).
- Dial **2** to select the activation status option.
- Dial **0** to turn the port on, dial **1** to turn the port off.
- Press **TRANSFER** to store your selection and exit programming.

## DISPLAY FEATURES

### INTERACTIVE DISPLAY KEYS

The three keys below the display are substitutes for dedicated feature keys and access codes. Pressing one of these buttons has the same effect as pressing a programmable button. These buttons are called soft keys as their functions are not fixed. They change to present you with the best options for that call condition. The use of soft keys allows the programmable buttons to be used for more **DSS** and speed dial buttons.

The **SCROLL** button is used to display options available to the user at a particular time or during a specific procedure. Press this button once while in the idle state to view the three main categories available.

201:STN NAME  
CALL OTHER ANS

**ANSWER:** Guides you through the options to answer calls.

**OTHER:** Guides you through features other than making or answering calls.

**CALL:** Guides you through the options to make a call.

Select one of the main categories: **CALL**, **OTHER** or **ANS (ANSWER)**. Press the **SCROLL** button to display additional options available under each of the three main categories. The symbol ➡ displayed as the last character on the lower line of the display indicates that there are additional options. Press the **SCROLL** button to display these additional options.

User instructions will be displayed in lower case letters. Options assigned to soft keys will be in upper case letters.

### DIRECTORY INFORMATION

An 11 character directory name can be assigned to each extension number. Display keypad users can view the name of the called or calling station before answering.

Each outside line can have an 11 character directory name. Incoming calls can be easily identified and answered with different greetings.

Outside and internal calls ringing to a station group will display [CALL FOR xxx] where xxx is the station group number. This allows you to answer calls directed to you differently than calls directed to your group.

## CALL LOG *(See also Special Application Menu-Outgoing Call Log)*

The system can log both incoming and outgoing calls placed from or to your telephone. You must have a **LOG** button programmed on your keyset and assigned a review list.

Each **IN** and **OUT** list can be up to 50 numbers maximum. They are assigned in blocks of 10 each.

- Press the **LOG** key.
- Press either the **IN** or **OUT** key.
- View the first IN/OUT telephone number. At this point you may select one of the three options related to this number or use the UP/DOWN keys to scroll through your list of calls.
- Press the **CLEAR** button to erase this number from the list.
- Press the NND key repeatedly to view the Name, Number, or Date associated with this call.
- Press the **DIAL** key to call this number.

These options are the same for the incoming or outgoing call logs.

## DIAL BY NAME *(See also Special Application Menu-Name Search)*

Each station or speed dial number can have an associated directory name. A station or speed dial number can be selected by scrolling alphabetically through a directory name list. This on-line “phone book” allows the user to look up and dial any station or speed dial number in seconds.

- Press the **DIR** button (**DIRECTORY**).
- Select the directory you wish to use: **PERS** (personal speed dial numbers), **SYS** (system speed dial numbers) or **STN** (station names).
- Dial the key on the keypad that corresponds to the first letter of the name you wish to search for.
- Use the **UP** and **DOWN** arrows to scroll through the names.
- Press the **DIAL** soft key to dial the number.

NOTE: A **DIR** button can have an extender to take you directly to one of the above lists (PERS, SYS, or STN).

## CALL PROGRESS DISPLAYS

During everyday call handling, your keyset display will provide information that is helpful and in some cases invaluable. Displays like [CALL FROM 203], [TRANSFER TO 202], [701: RINGING], [TRANSFER FM 203], [708 busy], [Camp on to 204], [Recall from 204], [Call for 501], [message frm 204] and [FWD ALL to 204] keep you informed of what is happening and where you are. In some conditions you are prompted to take an action and in other cases you receive directory information.

## DISPLAY NUMBER DIALED

Display keysets begin showing digits as they are dialed. They will stay in the display until the call duration timer comes on automatically or the **TIMER** button is pressed. If the call duration timer is not used, the number dialed will be displayed until the call is released, transferred or put on hold.

## CALL DURATION TIMER

The system can be set to automatically time outside calls. A few seconds after you dial a telephone number, the timer appears in the display. It appears immediately for incoming calls. The call timer continues for the duration of the call. Call duration times are displayed in minutes and seconds. If a call lasts longer than 60 minutes, the timer restarts.

You can press the **TIMER** button to manually begin timing a call. Press it again to stop timing. If you press it while the automatic timer is on, the call duration time is restarted.

## AUTO TIMER

Display keyset users may have the timer automatically start when they answer incoming calls or after a short delay on an outgoing call.

- With the handset on-hook, press **TRANSFER** and then dial **119**.
- Dial **41** to turn the auto timer on or **40** to turn it off.
- Press **TRANSFER** to store your selection.

## TIMER FUNCTION

Display keyset users may use this feature as a simple stopwatch.

- When the keyset is idle, press the **TIMER** button to start timing.
- Press the **TIMER** button again to stop timing.
- Read the elapsed time in the display.
- Lift the handset and replace it. The display will return to date and time.

## VIEWING MESSAGE INDICATIONS

You can view all of your message indications before you return them:

- With the handset on-hook, press the **MESSAGE** button with the red flashing light.
- The first station that left a message indication will be displayed.
- Press the **UP** and **DOWN** arrows to scroll through the stations that left message indications. Use the soft keys to reply, clear or advance to the next message.
- Press the **END** button to return your keyset to the idle condition.

## ALARM REMINDER MESSAGES

*(See also Special Application Menu-Name Search)*

When you use the alarm/appointment reminder feature, you create a 16 character reminder message. When the alarm rings, your message will appear instead of [ALARM REMINDER]. To program reminder messages:

- Press **TRANSFER** and then dial **116**.
- Dial the alarm number **1, 2** or **3**.
- Dial the time you want the alarm to go off. Enter the time as HHMM (hours and minutes) using the 24 hour clock.
- Dial **0** (NOT SET), **1** (TODAY) or **2** (DAILY) to select the alarm type.
- Write your message using the dial pad keys. Each press of a key selects a character. Pressing the next key moves the cursor to the next position. For example, if your message is "TAKE MEDICATION," press **8** once to get the letter "T." Press **2** once to get "A." Press **5** twice to get "K." Continue selecting characters from the following table to complete your message.
- Press the **TRANSFER** button to store the alarm and reminder message.
- Repeat for each alarm if needed.

COUNT	1	2	3	4	5
DIAL 0	<	>	.	)	0
DIAL 1	space	?	,	!	1
DIAL 2	A	B	C	@	2
DIAL 3	D	E	F	#	3
DIAL 4	G	H	I	\$	4
DIAL 5	J	K	L	%	5
DIAL 6	M	N	O	^	6

DIAL 7	P	Q	R	S	7
DIAL 8	T	U	V	Q	8
DIAL 9	W	X	Y	Z	9
DIAL *	:	=	[	]	*

NOTES:

1. When the character you want appears on the same dial pad key as the previous character, press **UP** to move the cursor one space to the right.
2. Other symbols are available for DIAL #.

To cancel an individual alarm and reminder message:

- Press **TRANSFER** and then dial **112**.
- Dial alarm number **1, 2** or **3**.
- Press the **HOLD** button.
- Press the **TRANSFER** button.

## PERSONAL SPEED DIAL NAMES

Each personal speed dial number can have an 11 character name assigned to it. This name is used to select the speed dial bin when you are dialing by directory.

- Press **TRANSFER** and then dial **106**.
- Dial the speed dial bin number **00–49**.
- Write your message using the procedure described in *Alarm Reminder Messages*.
- Press the **TRANSFER** button to store the speed dial name.
- Repeat for each speed dial bin if necessary.

## STATION NAMES

You can assign an 11 character name to your keyset. This allows other display keyset users to call you using the directory dial feature.

To program a station name:

- Press **TRANSFER** and then dial **104**.
- Enter the 11 character name using the procedure described in [Alarm Reminder Messages](#).
- Press **TRANSFER** to store the name.



## MANAGING KEY ASSIGNMENTS

You can view your key assignments and add extenders to some of your programmable keys for easy one touch operation of frequently used features.

- While on-hook, press **TRANSFER** and then dial **107**.
- Use the **VOLUME** buttons to scroll through all of your programmable buttons **OR** press the programmable button to which you want to add the extender.
- When you reach a key listed below, dial the corresponding extender.
- Press **TRANSFER** to store and exit programming.

Please refer to the [Enhanced Display Programming Section](#) provided by your installation company when requested for a complete list of descriptions and extenders for any keys you may have programmed on your keyset.

NOTE: Confirm that the cursor is placed correctly before you enter the extender.

## LCR WITH CLEAR

When you are making an outside call using LCR and dial an incorrect digit, you can press the **CLEAR** soft key to reenter the telephone number. You do not need to redial **9** to reaccess LCR.

## BACKSPACE WITH LCR

If you misdial while using LCR, you can delete digits shown in the display by pressing the **BSPC** soft key as many times as necessary.

## TEXT MESSAGING

This feature allows two digital keyset users to respond to each other with preprogrammed text messages. After receiving an Off Hook Voice Announcement or Station Camp-On, you may respond with a text message while continuing to talk and listen to your outside party. The other station can view this message and take the appropriate action or respond back with another text message.

You **must** be permitted to use the Text Messaging feature. See your System Administrator or Technician to be assigned this feature. They will assign you ten (10) blank messages. You can create any 16 character messages (01 to 10) that are appropriate for your use.

NOTE: See [ALARM REMINDER MESSAGES](#) for instructions on how to enter characters to create a text message.

Familiarization with the two digit message numbers you will use the most will make this procedure quick and easy. However if you do not know them, use the **UP/DOWN** button to scroll to the desired message, then press **SEND**.

The basics steps in text messaging are:

1. Press **TMSG** soft key to begin text messaging.
2. Dial the 2 digit number for the desired message.
3. Confirm this is the intended message then press **SEND**.
4. Wait for a reply from the other station (steps 1, 2 & 3)
5. When any station presses **EXIT** the displays at both stations return to their previous call progress condition.

At all times after step 1 you can talk and listen to your caller while repeating steps 2.

The following example will better demonstrate how to use Text Messaging. In this example station 201 is making an off hook voice announcement to station 205 who after hearing the announcement will respond with a text message.

**STATION 201: LINDA**

received a call on line 702

**STATION 205: JOHN**

is talking on line 701

Talking on line 702

<b>702 :</b>	<b>01 : 15</b>
<b>CONF</b>	<b>PAGE MUTE</b>

<b>701 :</b>	<b>05 : 25</b>
--------------	----------------

Press **TRANSFER**

**Transfer:**  
**RETURN**

Dial **205**

**205:busy**  
**OHVA**      **CAMP ON**



**OHVA to 205**

**OHVA from 201**  
**TMSG**      **REJECT**

**Wait for reply**

**GIVE THE CALL**  
**TMSG:01**      **SEND**

Dial **03** or press ↑ twice

**ASK THEM TO HOLD**  
**TMSG:03**      **SEND**



**ASK THEM TO HOLD**  
**TMSG**      **EXIT**



**Wait for reply**

**702:**      **01:45**  
**CONF**    **PAGE**    **MUTE**

**701:**      **05:55**  
**CONF**    **PAGE**    **MUTE**

# CALLER ID

## WHAT IS CALLER ID?

Caller ID is the name given to the telephone company-provided feature that delivers the telephone number and sometimes the name of the person calling your phone. There are two types of Caller ID; the first delivers the calling party's telephone number only and the second (sometimes referred to as "Deluxe" Caller ID) delivers both the calling party's telephone number and name as listed in the telephone directory.

The phone system can handle both types of Caller ID; in fact, in the case of number only delivery, the system can be programmed to insert a name for a specific telephone number. However, even though you are paying to receive Caller ID information, there are some circumstances that mean you will not receive this information. The six most common reasons are listed below along with the display information that the system will provide.

- |                  |  |
|------------------|--|
| PRIVATE          | The caller does not wish his/her name or number to be revealed to you. This type of call can be stopped at the telephone company by dialing an access code on your outside lines. This will redirect these PRIVATE calls to an announcement that states that you do not wish to receive calls that have had Caller ID blocked. The code to block these calls can usually be found in the front section of the telephone directory. |
| OUT OF AREA      | The caller is calling from an area that cannot provide Caller ID information (for example, international calls) or he/she is calling from a type of circuit that cannot provide Caller ID information, for example, some outbound WATS lines.  |
| PAYPHONE         | The caller is calling from a coin-operated telephone. The telephone company will send this information as there are no directory listings for pay phones. The number will be delivered as usual.   |
| INVALID CID INFO | This is a message that will be displayed when CID information is sent on the line but was somehow corrupted.   |
| NO CID RECEIVED  | This is a message that will be displayed when there was no CID information sent on the line.   |

NO CID DSP      Caller ID Digital Signal Processors (CIDDSP's) are resources in the OfficeServ 100, OfficeServ 500, and OfficeServ 7000 Series systems required for receiving CID data. If there are no CIDDSP's available at the time a call comes in, this is the message you will see on your display.

NOTE: The Caller ID features may require optional software and/or hardware. Please see your service and installation company for details.

## WHAT IS ANI?

[T1/E&M NOT SUPPORTED ON THE OS 7030, OS 7100 and OS 7200-S]

ANI (Automatic Number Identification) is a feature offered by some telephone service providers that provides the calling party's telephone number. This service is only available on E&M Tie Lines on a T1, digital trunk. ANI is similar to Caller Identification (CID) but the format and information of the calling person is different. CID uses FSK signalling and ANI uses DTMF signalling. Usually, with ANI, a calling party's identity is the Listed Directory Number (LDN) unless a separate bill-to-number has been specified, (in which case the bill-to-number will be sent). Note that ANI does not provide calling party NAME, only the number. The phone system can provide calling number to name translation table.

## WHAT IS CLI?

On ISDN circuits, calling party information is called CLI and is supported on both BRI (not supported in the US) and PRI type circuits (not supported on OS 7030). On BRI circuits the system only supports number delivery and, like ANI, a name can be attached to the telephone number of frequent callers via the Caller ID translation table. On 5ESS and NI2 PRI circuits both name and number support is provided on the OfficeServ 100, OfficeServ 500, and on the OfficeServ 7000 Series systems.

## SELECTING YOUR CALLER ID DISPLAY

Simultaneous display of Caller ID and Number on Incoming CO calls on both lines of display keysets is supported on all OfficeServ systems. On Transferred CO calls, you can decide if you want to see the Caller ID name or Caller ID number in the display. Regardless of which data is selected, you can press the **NND** button to view the other pieces of Caller ID information. To select the type of Caller ID information you wish to view:

- With the handset on-hook, press **TRSF** and then dial **119**.
- To set the first line of a ringing call display dial **0**.
- To set the second line of a ringing call display dial **1**.

Set the data to display from the following:

- To show nothing dial **0**.
- To show Caller ID Number dial **1**.

- To show Caller ID Name dial **2**.
- To show the DID Number the call came in on dial **3**.
- To show the Name of the DID the call came in on dial **4**.
- To show the Name of the Group the call came in for dial **5**.
- To show the DID Number and then Name of the DID dial **6**.
- To show the Name of the DID and then the DID Number dial **7**.
- To set the top line of the display shown after answering a call dial **2**.  
Set the data to display from the following:
  - To show Caller ID Number dial **0**.
  - To show Caller ID Name dial **1**.
  - To show the DID Number the call came in on dial **2**.
  - To show the Name of the DID the call came in on dial **3**.
  - To show Caller ID Number and then the DID Number dial **4**.
  - To show Caller ID Name and then the DID Number dial **5**.
  - To show the DID Number and then the name of the DID dial **6**.
  - To show the Name of the DID and then the DID Number dial **7**.
  - To show the C.O. line information dial **8**.
- To set the format if the C.O. line information when the above is set to show C.O. line information dial **3**.
  - To show the C.O. line number and the dialed or Caller ID Number dial **0**.
  - To show only the dialed or Caller ID Number dial **1**.
- Press **TRANSFER** to exit and store your selection.

## VIEWING THE NEXT CALLER ID CALL

In the event that you have a call waiting or a camped-on call at your keyset, you can press the **NEXT** button to display the Caller ID information associated with the call in queue at your keyset. Either the CID name or CID number will show in the display depending on your Name/Number selection.

To view Caller ID information for calls that have been camped-on to your keyset, press the **NEXT** button. If your keyset does not have a **NEXT** button, press the **CID** button and then the **NEXT** soft key.

## SAVING THE CALLER ID NUMBER

At any time during an incoming call that provides CID information, you may press the **SAVE** button to save the CID number. If your keyset does not have a **SAVE** button, press the **CID** button, the **SCROLL** button and then the **SAVE** soft key. The system must be using LCR to dial the saved number.

## REDIALING A SAVED CALLER ID NUMBER

To redial a number that has been saved, press the **SNR** button or dial **17**.

### NOTES:

1. Your telephone system must have LCR correctly programmed to redial the saved number.
2. If the Hot Keypad feature has been turned off, you must first lift the handset or press the **SPEAKER** button before you begin dialing.

## STORING A CALLER ID NUMBER

At any time during an incoming call that provides CID information, you may save the CID number as a speed dial number in your personal speed dial list. To store a Caller ID number in a personal speed dial bin:

- Press the **STORE** button. The system displays the speed dial bin in which the number was stored, **OR**
- Press the **CID** button and then press the **SCROLL** button.
- Press the **STORE** soft key.
- The system displays the speed dial bin in which the number was stored.

NOTE: Your telephone system must have LCR correctly programmed to redial the saved number. If LCR is not being used on your system, you will not be allowed to STORE CID numbers.

## INQUIRE CALLER ID PARK/HOLD INFO

If you are informed that an incoming call is on hold or has been parked for you, you may view the Caller ID information before you retrieve the call. This may influence how you choose to handle the call.

From an idle keyset:

- Press the **INQUIRE** button, **OR**  
Press the **CID** button and then the **INQUIRE** soft key.
- Dial the trunk number.
- You may now answer the call by pressing the **ANS** button, **OR**  
You may use **NND** to view more information about this call, **OR**  
You can return to the idle condition by pressing **IGNORE**.

If you are on a call:

- Press the **INQUIRE** button. Your existing call will go on hold, **OR**  
Press the **CID** button and then the **INQUIRE** soft key to place the first call on hold.

- Dial the trunk number.
- You may now answer the call by pressing the **ANS** button, **OR**  
You may use **NND** to view more information about this call, **OR**  
You can return to the idle condition by pressing **IGNORE**.

### NOTES:

1. If you are on an intercom call or you have Automatic Hold turned off, you must finish the existing call or place it on hold before inquiring.
2. If you inquire about an outgoing call, you will receive a [call no longer available] display.

## REVIEWING PAST CALLER ID CALLS

This feature allows you to review CID information for calls sent to your keyset. This list can contain 10–50 calls in a last-in, first-out basis. The list includes calls that you answered and calls that rang your keyset but that you did not answer (missed calls). When reviewing this list, you can press one button to dial the person back. The system must be using LCR to dial the stored number. To access the CID information stored in your REVIEW list:

- Press the **REVIEW** button, **OR**  
Press the **CID** button and then press the **REVIEW** button.
- If you have entries in your review list, the most recent call will be shown first.
- You can now **CLEAR** this entry, **OR**  
Use **NND** to view more information about this call, **OR**  
Press **DIAL** to call this person back, **OR**  
Press **SCROLL** and then press **STORE** to save this number in a personal speed dial bin.

### NOTES:

1. Each keyset defaults with ten review bins. Please see your system administrator to determine the number of bins assigned to your keyset.
2. Your system must have LCR correctly programmed to allow you to **DIAL** numbers from the review list or to **STORE** entries from the review list.

# SPECIAL APPLICATION MENU

Below are instructions for additional call processing and special applications that can be accomplished via the LCD programming. These features and functions can be accessed by pressing the **MENU** button. Follow the user instructions below to utilize these features and functions.

After pressing the **MENU** button, use the direction button to scroll to the desired menu option. Press **ENTER** to access the menu. To navigate within the menu you may scroll to the desired option/function or dial the associated option function number.

Press **END** button to exit programming.

## MENU OPTIONS

Note that some of the features listed here may require system programming and configuration in order to function. See your system administrator for details.

Press the **MENU** button to access the options below. Use the **UP/DOWN** directional button to scroll to, and within option menus and sub menus. You may also dial the option number, after pressing the **MENU** button.

**1. OUTGOING LOGS:** Allows you to view a list of the 30 most recent outgoing calls from the keyset. You may return the call directly from the displayed status.

- Scroll or dial option number **1. Outgoing Call Log**.
- Press **ENTER**.
- Scroll to the desired **PHONE NUMBER** and press the **SEND** button to automatically dial the number.

OR

- Press **CANCEL** to return to Main Menu.

OR

- Press **END** to exit programming.

**2. INCOMING LOGS:** Allows you to view a list of the 30 most recent incoming calls to the keyset. You may return the call directly from the displayed status.

- Scroll or dial option number **2. Incoming Call Log**.
- Scroll to the desired **PHONE NUMBER** and press the **SEND** button to automatically dial the number.

OR

- Press **CANCEL** to return to Main Menu.

OR

- Press **END** to exit programming.

**3. SPEED DIAL:** Allows you to search through Station and System Speed Dial Numbers. You may dial the number directly from the displayed status.

- Scroll or dial option number **3. Speed Dial**.
- Press **ENTER**.
- Scroll to option or dial desired option.

1. Personal Speed
2. System Speed

- Press **ENTER**.

OR

- Scroll to the desired number and press the **SEND** button to automatically dial the number.

OR

- Press **CANCEL** to return to main menu.

OR

- Press **END** to exit programming.

**4. DIRECTORY DIAL:** Allows you to search for station speed, system speed and station numbers based on their associated programmed name.

- Scroll or dial option number **4. Directory Dial**.
- Press **ENTER**.
- Scroll to option or dial desired option.

1. Personal Speed
2. System Speed
3. Station Number

- Enter the name associated with that speed number or station number.
- Press the **SEND** button to automatically dial the number.

OR

- Press **CANCEL** to return to main menu.

OR

- Press **END** to exit programming.

**5. FORWARD SET:** Allows you to assign station call forward condition for the phone. You must first set the forward type and destination (Options 2-5) then activate the forwarding in option 1.

- Scroll or dial option number **5. Forward Set**.
- Press **ENTER**.

- Scroll to or dial the desired forward option and assign station number to forward your station to.

- 2. ALL FWD NO.
- 3. BUSY FWD NO.
- 4. NOANS FWD NO.
- 5. DND FWD NO.
- 0. FWD CANCEL
- Press **ENTER**.
- Scroll to or dial **1. FORWARD TYPE** and scroll to or dial the desired forward type.
- Press **ENTER** to activate the desired call forward type.
- Press **CANCEL** to return to main menu.

OR

- Press **END** to exit programming.

**6. ALARM REMINDER:** Allows you to set an Alarm Reminder. Up to three alarms may be set.

- Scroll or dial option number **6. Alarm Reminder**.
- Scroll or dial the desired Alarm number (Alarm 1-3).
- Press **ENTER**.
- Enter Alarm Type.
  - 0. NOT SET: Disables alarm.
  - 1. TODAY: Rings alarm one time only, on the day set.
  - 2. DAILY: Rings alarm daily at time set.
- Press **ENTER**.
- Display confirms setting and returns to that alarm set menu.
- Scroll up to set **ALARM TIME**.
- Press **ENTER**.
- Enter **ALARM TIME** (Military Format).
- Press **ENTER**.
- Display confirms setting.
- Press **CANCEL** to return to main menu.

OR

- Press **END** to exit programming.

## Samsung Voicemail

This section describes how to setup and use the various features available to a Subscriber. A Subscriber is a person that has been authorized access to the various features and services available in the Samsung Voicemail. Please review this section carefully before you use your Authorized Features and Services, known as Subscriber Services.

Voicemail is one of the Subscriber Services available. Your voicemail box has the capability of storing private messages, and offers a number of options for sending or redirecting messages as well as provides several ways to notify you of new messages.

Another very common Subscriber Service is Access Manager. This allows you control over when and where you receive your calls as well as what to speak to your callers in the event you are unable to speak to them directly. The 'events' are referred to as "Call Conditions": No-Answer, Busy, and Blocked are the most commonly used Call Conditions.

This guide can be used by Subscribers from within the office or from telephones outside the office. The basic operation is the same, but the access method will be different. [See the Samsung Voicemail Subscriber Services Menu Diagram for more details.](#)

Note that some features and prompts detailed here may not be available to all Subscribers. See your System Administrator if you have questions about feature availability.

# Samsung Voicemail Subscriber Services Menu

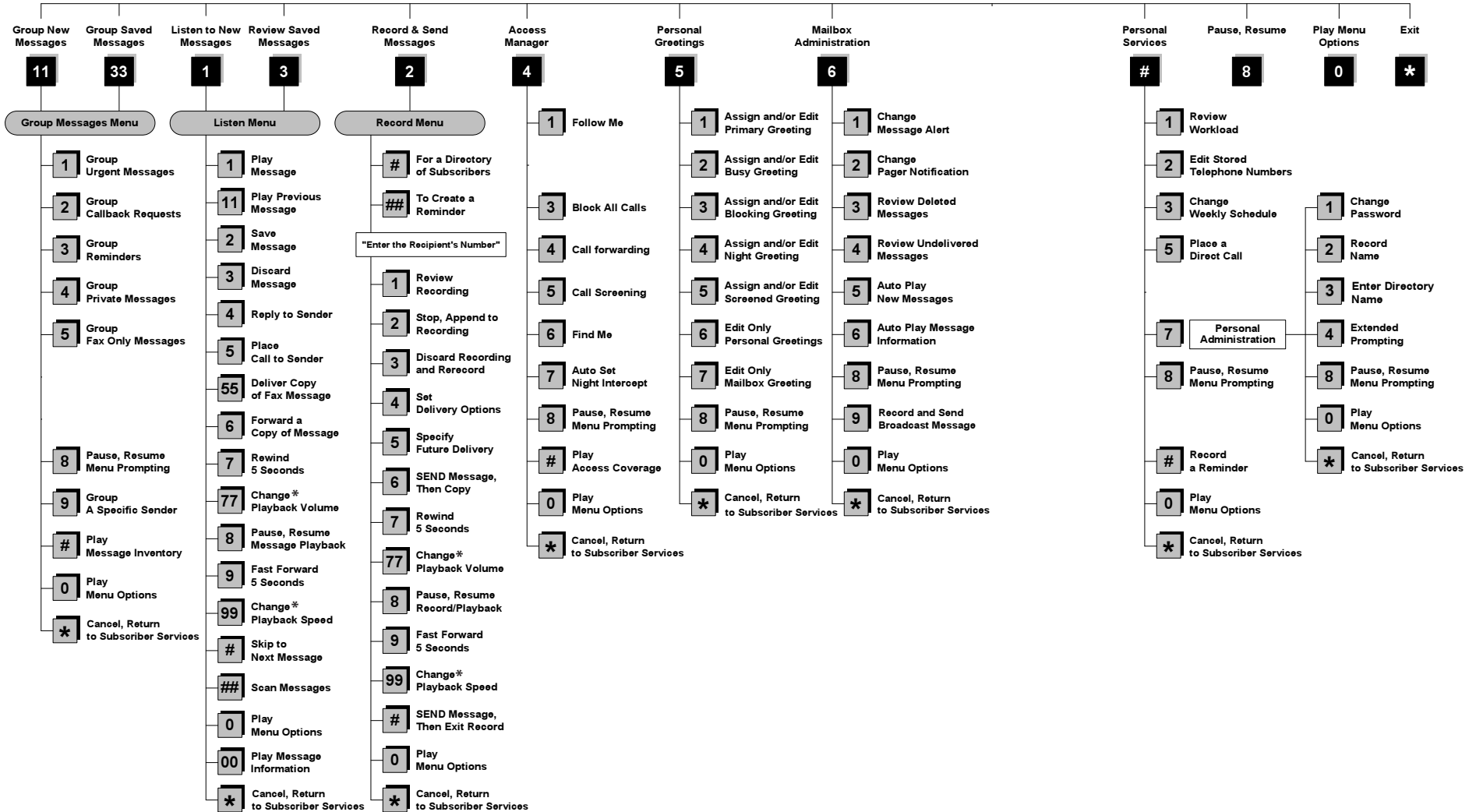

NOTE: All options shown MAY NOT be authorized. If an option is not available please speak to your system administrator.

\*Change Playback Volume and Speed not available on the OfficeServ 7030, OfficeServ 7100, OfficeServ 7200-S or OfficeServ IP-UMS

## ACCESSING YOUR MAILBOX

*[Also known as Subscriber Services Menu]*

### Inside Callers *[Subscriber logging in from their Desk]*

- Dial the voicemail access number or press the key assigned to ring the Samsung Voicemail **[VMMSG]**.
- Enter your personal password when prompted (the default password is 0000).

### Outside Callers *[Subscribers calling from Cell Phones or outside of the office environment]*

- Dial the phone number that will be answered by the Samsung Voicemail. The main greeting will answer.
- At the main greeting dial **[#]** plus your Subscriber (or mailbox) number (Subscriber and Mailbox numbers will usually match your extension number).
- Enter your personal password when prompted (the default password is 0000).

### Access your Subscriber Services (or Mailbox) from a Station other than your Own (or checking a mailbox associated with a different station)

- Press the **[VMMSG]** key or dial the voicemail **group number**. You will be prompted to enter a password.
- Press **[\*]**. This will take you to the Main Auto Attendant Menu.
- Press **[#]** plus the Subscriber number of your choice. You will be prompted to enter your password.

At this point the inside and outside callers follow the same instructions. You will hear a message stating the number of messages left in your mailbox. You will then hear the Subscriber Services Menu with the following options:

- 1 Listen to New Messages - [See Listening to your Message.](#)**
- 2 Record and Send Message - [See Sending Messages.](#)**
- 3 Review Saved Messages - [See Listening to your Message.](#)**
- 4 Access Manager - [See Access Manager.](#)**
- 5 Personal Greetings - [See Personal Greetings.](#)**
- 6 Mailbox Administration - [See Mailbox Administration.](#)**
- # Personal Services - [See Personal Services.](#)**
- \* Return to Main Menu.**

## GETTING STARTED

Using your new Samsung Voicemail Subscriber Services is as simple as following a few simple spoken instructions. First time users should read this section as a tutorial. You should start with the following steps:

- Access your Subscriber Services Menu - You already know how to do this.

### From the Subscriber Services Menu:

- Record a Primary/No-Answer Personal Greeting. Dial **[5][1]**.
- Record a Mailbox Greeting. Dial **[5][7]**.
- Change your access code (Password). Dial **#[7][1]**.
- Record your name. Dial **#[7][2]**.
- Enter your directory name. Dial **#[7][3]**.

After you have completed the steps above your Subscriber Services are set up and ready to use.

## LISTEN TO YOUR MESSAGES

If there are new messages in your mailbox your **[VMMSG]** key will be lit. Call the Samsung Voicemail by pressing this key, and when prompted enter your password. You will then be at the Subscriber Services Menu. Select **[1]** to listen to new messages or **[3]** to listen to saved messages.

Note: After you enter your password, if "Autoplay of New Messages" is enabled and you have new messages the Samsung Voicemail will begin to play them automatically. A subscriber can control this feature. From the Subscriber Services Menu **[6] [5]** toggles "Autoplay of New Messages" ON/OFF.

## SUBSCRIBER SERVICES MENU

The following is a list of all the options available in the Subscriber Main Menu.

- 1 LISTENING TO NEW MESSAGES**
- 11 GROUP NEW MESSAGES**
- 2 RECORD AND SEND A MESSAGE**
- 3 LISTENING TO OLD MESSAGES**
- 33 GROUP OLD MESSAGES**
- 4 ACCESS MANAGER**
- 5 PERSONAL GREETINGS**
- 6 MAILBOX ADMINISTRATION**
- 8 PAUSE / RESUME**



- 0 PLAY MENU OPTIONS
- \* EXIT TO AUTO ATTENDANT
- # PERSONAL SERVICES

## 1 or 3

### LISTENING TO OLD OR NEW MESSAGES

- 1 Play / replay the message you just heard.
- 11 Play the previous message.
- 2 Save the message you just heard and listen to the next message.
- 3 Delete the message you just heard and listen to the next message.
- 4 Reply to the message.  
This will allow you to leave a message in the mailbox of the sender (if the sender has a mailbox on this system).
- 5 Return the call directly to the telephone number that left the message.  
This will work for internal and external callers, but Caller ID service is needed to use this feature on an outside call.
- 55 Deliver a fax copy.  
This will allow you to receive attached faxmail document(s). Faxmail documents can be delivered to any fax machine of your choice as long as out calling is authorized. You can also have faxmail messages automatically delivered to the fax machine of your choice.
- 6 Forward the message and saves a copy.  
The subscriber can be selected by dialing their mailbox number (nnn), using the directory service (#) or you may also add comments and leave it as a memo to yourself (##).  
The Send and Copy Service (option 6) allows a user to send copies of a message to multiple recipients easily. A different introduction message may be left for each recipient.
- 7 Rewind the message 5 seconds.
- 77 Change playback volume of the recording. **[Not available on the OS 7030, OS 7100, OS 7200-S or OS IP-UMS]**  
There are two levels of volume during playback. Dialing this code will toggle between the two levels.
- 8 Pause or resume during message playback.
- 9 Fast forward the message 5 seconds.

- 99 Change playback speed of the recording. **[Not available on OS 7030, OS 7100, OS 7200-S or OS IP-UMS]**  
There are two levels of speed during playback. Dialing this code will toggle between the two speeds.
- 0 Play options.  
Pressing this key will play all the menu options available to you from this point.
- 00 Hear the time and date, and sender's information of the message you just heard. Sender information is not available on outside calls.
- # Move to the next message. This does not Save or Discard the current message - it is retained as new.
- ## Scan. Plays first 7 seconds of a message then skips to next message. This is similar to the scan button on a radio. It will allow you to find a specific message quickly. To stop scanning press [1].
- \* Cancel and return to previous menu.

## 11 or 33

### GROUP NEW OR OLD MESSAGES

Messages can be grouped as either Reminders, press [3] or Messages from a specific sender, press [9].

Additionally you can press [#] and hear a summary of your mailbox contents:

- a) Number of messages
- b) Number of reminders
- c) Number of urgent messages
- d) Number of messages needing a callback
- e) Number of private messages
- f) Number of fax messages

## 2

### RECORD AND SEND A MESSAGE

This option is used to send a message to another subscriber. The steps are simple:

- a) Enter the recipient's mailbox number, or if this is not known enter [#] to use the system directory.

b) Record your message at the tone. After recording the message, you will hear the Send Menu with the following functions:

- 1 Review
- 2 Continue Recording
- 3 Discard and Re-Record
- 4 Set Message Attributes (Delivery Options)
- 5 Schedule Future Delivery
- 6 Save and Send then Send a Copy to Someone Else
- # Save and Send the Recording

## Setting Message Attributes

If after recording a message you select [4] you can set up any combination of the following delivery options:

- 1 Urgent Delivery
- 2 Return Receipt Requested
- 3 Request a Call Back
- 4 Private Delivery
- 5 Reply Required
- \* Exit

## Scheduling Future Delivery

If after recording a message you select [5] to schedule future delivery, you will be able to set message attributes and set this message as:

- # Immediate Delivery
- 1 Next Few Hours
- 2 End of Current Business Day (based on your Availability Schedule)
- 3 Beginning of Next Business Day (based on your Availability Schedule)
- 4 A Coming Day of the Week
- 5 Specific Day / Time
- \* Exit

# 4

## ACCESS MANAGER

The Access Manager allows the subscriber to set a number of options for when, where and how, and/or if the Samsung Voicemail contacts you when a caller dials your extension number. All of the options are toggled on/off based on their current status when you access them.

**Note: ALL** Access Manager options **MUST** be individually allowed by the System Administrator for each Subscriber. They are:

### 1 Follow Me

Allows the subscriber to enter an alternate location and set how long the new destination (Designated Location) will be active. This number may be an internal or external number. This is useful if you are frequently traveling or changing the number where you can be reached.

When Follow Me is activated, the transfer will be supervised and confirmed. This means that if the call is not answered or if rejected by the Subscriber at the designated location it will be recalled to the Subscriber's mailbox.

### 3 Call Blocking

When this feature is active, callers will not be transferred to your extension, they will hear your 'blocked' greeting (if recorded) and will go directly to your mailbox if they do not select any or are not offered any other options.

### 4 Call Forwarding

Unlike Follow Me where the subscriber wants to take their calls at an alternate location this feature allows the subscriber to pass control of his calls to another Subscriber. The "Forwarded To" Subscriber will now be in control of the caller and the caller will NOT return to originating Subscriber's Mailbox. If the "Forwarded To" Subscriber does not answer the caller it will now follow what ever the "Forwarded To" Subscriber has set up for their call conditions. The Caller will hear "Forwarding to" "{Subscriber Name}" before actually being forwarded.

### 5 Call Screening

If this is turned on, the caller will be asked their name and the Samsung Voicemail will play this name to you before the transfer, giving you an option to accept or reject the call.

### 6 Find Me

Find Me, when enabled, will attempt to locate the subscriber by calling a list of preprogrammed phone numbers. The stored phone numbers are entered in 'Personal Services' [#][2] (if allowed by the Administrator). The stored telephone number list can contain up to 9 preprogrammed telephone numbers. The Find Me feature only use the first five.

### 7 Night Intercept

This feature is dependent on your weekly availability schedule, which is entered in 'Personal Services' [#][3] (if allowed by the Administrator). When Night Intercept is active the Samsung Voicemail will first ring your extension

then play your primary, No Answer greeting during the day (when you are available) and will NOT ring your extension but simply play your Night greeting during the night (when you are not available).

**Note:** This does NOT use the Day and Night schedules of the phone system. It is solely controlled by the Subscriber's Availability Schedule.

## 8 Pause / Resume

## \* Exit from Access Manager

## 0 Play All Options

## # Play Access Coverage

This feature is useful for finding out how your current access settings are set. It will also tell you what greetings will play under each of the call conditions you have setup.

# 5

## PERSONAL GREETINGS

The options available in this menu will be determined by your System Administrator, and not all of them may be available to you. In the simplest systems, only a mailbox greeting will be available, additional greetings may be accessible in more complex systems.

Your Personal Greeting will be played every time someone dials your extension and you do not answer.

You may record up to 9 Personal Greetings, and you may assign any one of them to be active. There are several different 'Call Coverage' conditions to which you may assign any of your 9 greetings. The Call Coverage Conditions are: No-Answer, Busy, and Do Not Disturb (or Forwarded All). This will allow different greetings to play depending on the type of call forward that you have set, or the condition of your telephone.

The Call Coverage conditions that you can assign specific greetings to are selected by the following digits:

### 1 Primary/No Answer Greeting

Used when in your office, away from your desk or during the time period you are scheduled available. If this is the only Personal Greeting you record, it will play for all call coverage conditions.

This option is available only if the Administrator has assigned you the 'Basic Greeting' feature.

Example: "Hi this is John Smith. I'm sorry I am not available to answer your call. If someone else can help you, please enter the extension number now. Or, to leave me a message, press 1."

### 2 Busy Greeting

Played to a caller when you are already talking to someone on your extension or the telephone at your Designated Location.

This option is available only if the Administrator has assigned you the 'Busy Greeting' feature.

Example: "Hi, this is John Smith. I'm on another line right now. If someone else can help you, please enter the extension number now. Or, to leave a message, press 1."

### 3 Call Blocking Greeting

Used while Call Blocking is enabled in your Access Manager or if your phone is forwarded ALL or DND.

This option is available only if the Administrator has assigned you the 'Call Blocking' feature.

Example: "Hi, this is John Smith. Sorry I missed your call, but I'm going to be out of the office for the next few hours. If someone else can help you, please enter the extension number now. Or, to leave me a message, press 1."

### 4 Night Greeting

Used during the time period you are scheduled UNAVAILABLE, usually after business hours during the evening and at night.

This option is available only if the Administrator has assigned you the 'Scheduling' feature.

Example: "Hi, this is John Smith. I've left the office for the evening. If you would like to try someone else, please enter the extension number now. Or, to leave me a message, press 1."

### 5 Call Screening Greeting

Used while Call Screening is enabled, and you REJECT a caller after listening to the caller's record name.

This option is available only if the Administrator has assigned you the 'Call Screening' feature.

Example: "Hi, this is John Smith. I'm sorry, but I am not available to speak with you at this time. If someone else can help you, please enter the extension number now. Or, to leave me a message, press 1."

## 6 Edit Personal Greetings

You may also edit/record each one of the greetings (1-9) at any time.

Select a greeting number to edit and follow the instructions to record your greeting. When you are done recording your greeting, you will be able to listen to the greeting you recorded, save the greeting you recorded and return to the previous menu, record the greeting again, or exit without saving the greeting.

Note: If you record only the greeting assigned to the No-Answer Call Coverage Condition, then that greeting will play to callers for all Call Coverage Conditions (No-Answer, Busy, Blocked, Night, and Rejected Caller). In this case, the salutation part of the greeting should be very general.

## 7 Edit Mailbox Greeting

Used whenever a caller reaches your mailbox or if you have not recorded any of the Call Coverage greetings. The way a caller is transferred to your mailbox greeting directly, is by another subscriber transferring the caller to your mailbox using the VT (Voicemail Transfer) key.

This option is available only if the Administrator has assigned you the 'Mailbox Greeting Option' feature.

Example: "Hi, this is John Smith. Please leave me a message, I will call you as soon as I can."

Note: This greeting will only play if none of the 5 personal greetings has played to the caller. A common usage for this Greeting is when another Subscriber is talking with a caller and uses the VT key on their phone to transfer the caller directly to your Mailbox.

# 6

## MAILBOX ADMINISTRATION

The Mailbox Administration menu is used to turn on and off your pager notification, message alert options and other message control features.

### 1 Message Alert

When this function is activated, the Samsung Voicemail will call any outside or inside telephone number, after each message is left in your voice mailbox.

To hear your message at the remote location when the voicemail calls you, after you pick up the telephone and answer you will be instructed that there is a message and to enter your password. Simply enter your password and you will now be logged in.

### Setting Up Message Alert:

- From the Subscriber Services Menu press **[6]** for Mailbox Administration.
- Press **[1]** for Message Alert.
- There are 4 options available to you:
  - Press **[1]** to toggle message alert on and off.
  - Press **[2]** to set the schedule when you would like to be notified.
  - Press **[3]** to be notified on urgent messages only.
  - Press **[4]** to set the destination phone number.

### 2 Pager Notification

When this function is activated, the Samsung Voicemail will call your beeper service and notify you after each message is left in your voice mailbox.

- From the Subscriber Services Menu press **[6]** for Mailbox Administration.
- Press **[2]** for pager notification.
- There are 4 options available to you:
  - Press **[1]** to toggle pager notification on and off.
  - Press **[2]** to set the schedule when you would like to be paged.
  - Press **[3]** to be notified on urgent messages only.
  - Press **[4]** to set the pager phone number.

### 3 Undelete

When this function is activated, the Samsung Voicemail will allow you to undelete any messages that you have recently deleted (up to the programmed Daily Maintenance Time, which is set to 3 a.m. by Default the following morning).

- From the Subscriber Services Menu press **[6]** for Mailbox Administration.
- Press **[3]** for Deleted Messages.

Deleted voicemail messages are temporarily stored in memory until 3 a.m. the following day. Select this option to recover ("undelete") previously deleted messages, during this period of time.

### 4 Undelivered Retrieval

When this function is activated, the Samsung Voicemail will allow you to recall any messages you have sent that have NOT yet been picked up by the recipient.

- From the Subscriber Services Menu press **[6]** for Mailbox Administration.
- Press **[4]** for Undelivered Messages.

This useful feature will allow you to cancel any messages that have NOT yet been picked up by the recipient.

### 5 Auto Play New Messages

If this option is enabled, after you enter your password correctly any new messages will immediately begin to play. To enable (or if already enabled toggle and disable) this feature:

- From the Subscriber Services Menu press **[6]** for Mailbox Administration.
- Press **[5]** to Set Auto Play of New Messages.

### 6 Auto Play Message Information

If this option is enabled, the date, time and sender's name will be played automatically before each message. If this is disabled, the information must be requested manually by pressing '00'. To enable (or if already enabled toggle and disable) this feature:

- From the Subscriber Services Menu press **[6]** for Mailbox Administration.
- Press **[6]** to Set Auto Play of Message Information.

## 9

## MESSAGE BROADCAST

This option will only be available if it has been allowed by the System Administrator.

### Broadcast to All Mailboxes

If you have been designated as a Subscriber Administrator, you may send a message to ALL mailboxes in the system.

- From the Subscriber Services Menu press **[6]** for Mailbox Administration.
- Press **[9]** for Broadcast Messages.

This option will only be available if your mailbox has been assigned Subscriber Administration privileges.

## #

## PERSONAL SERVICES

The Personal Administration Menu is used to set your password and record your name. Many of these features must be allowed by the System Administrator.

### 1 Workload Management

Allows you to access to all reminders, both Active and Pending. If authorized you can group your reminders as Commitments, Follow-Ups or Tasks for better organization. The system will flag each reminder as Active or Pending (pending means scheduled for future delivery).

### 2 Stored Numbers

Allows you to enter up to 9 stored phone numbers. The first five of these are used in the 'Find Me' feature, but any of them (1-9) can be easily dialed using only one digit followed by the pound key, to be used by many other features from within your subscriber space. (ie: "Follow Me", "Message Alert", "Pager Alert", and "Direct Call").

### 3 Schedule Availability

Allows you to enter a weekly availability schedule for use with Night Personal Greeting and the Auto Night Intercept feature. Follow the spoken directions to enter the days of the week and times you are generally available to talk to your callers. All other times you will be considered unavailable.

### 5 Place a Direct Call

Allows you to place a direct call out of the Samsung Voicemail from anywhere. You may either dial the number or dial a single digit 1-5 that corresponds to a stored number ([See Personal Services, 2 - Stored Numbers](#)). This feature must be authorized by the System Administrator and can be limited or opened to internal, local, and long distance calls.

### 7 Personal Administration

This area is used during the initial set up of your Subscriber Settings ([see next section](#)).

## PERSONAL ADMINISTRATION SETTINGS

This menu allows you to make changes to basic setup settings, that are rarely changed. Use these when you initially set up your personal Subscriber settings. You probably will not need to change them after that.

### 1 Setting your Password

- From the Subscriber Services Menu press **[#][7][1]**.
- The current password will be played and you will have the chance to change it.

### 2 Recording your Name

Use this option to record your name. Your recorded name is played in several different situations. It is important to record your name for proper operation of the Samsung Voicemail.

- From the Subscriber Services Menu press **[#][7][2]**.
- The current name will be played and you will have the chance to change it.

Note: It is possible that if you do not record your name and/or enter your Directory Name (described below), you will not be included in the Dial by Name Directory.

### 3 Entering your Directory Name

Use this option to enter your Directory Name. Your Directory Name is used by callers to find you if they do not know your extension number.

- From the Subscriber Services Menu press **[#][7][3]**.
- The current Directory Name will be played as a string of digits that are equal to your name spelled out on your telephone keypad. Follow the instructions to enter a new name. You will be prompted to enter your last name and then your first name.

This must be done in order for the directory feature to work correctly.

Note: It is possible that if you do not record your name (described above) and/or enter your Directory Name, you will not be included in the Dial by Name Directory.

### 4 Extended Prompting

Use this option to drastically reduce the number of prompts played in the subscriber interface (mailbox prompts). Change this setting only if you are very familiar with the user operation of the Samsung Voicemail.

Note: Remember if you know what digits to press, you can enter them at any time you do not have to wait to be prompted. This feature can be toggled on/off at anytime. Also if it is off you will be prompted within each subscriber menu to press zero for more options. This enables you to still be able to find out what to do if you were to get lost and extended prompting was disabled.

## KEYSET USER FEATURES

The following options are available if you have a display keyset. They require setup by the System Administrator.

### Message Waiting Lights

When new messages are left in your mailbox, the voicemail message light on your keyset will flash. Press this flashing key **[VMMMSG]** and follow the prompts to retrieve messages. This key may be pressed at any time to log into your Subscriber Main Menu.

### Answer Machine Emulation

If you have an Answer Machine Emulation key programmed on your keyset, you can use it to monitor calls going to your voicemail, and optionally answer them. The operation of this feature is similar to screening a call on a home answering machine.

Your keyset must be set to forward on no answer to voicemail. After ringing your station the caller will be connected to your voicemail and hear your personal greeting before leaving a message. During this time you will be monitoring the connection between the caller and your voicemail box. At this time you will only be monitoring the call, you can not talk to the other party until you answer. You may pick up the call at any time or ignore it.

To activate this feature press the **AME** button. The associated indicator will be lit steady. Press again to turn off. If this key is pressed while a station is ringing (during forward no answer), the feature will be turned on for the current call only.

While the caller is leaving a message or ringing you may:

- Press **[#]** to immediately put the caller in your voice mailbox and monitor it.
- Press **[\*]** to immediately disconnect your station. The caller continues to leave a message normally.
- Pick up the handset and monitor privately.
- Press **ANS / RLS** to answer the call (using the handset or speaker).

## AME Password

If your keyset has **AME PASSWORD** (MMC 110) set to **YES**, you must enter your station password to listen to messages being left. This will prevent unauthorized people from listening to messages being left for you.

If the password option is turned on, while a message is being left, press the flashing **AME** indicator and enter your station password (not your Samsung Voicemail password). You will then hear the message being left.

## Call Record

If you have a call record button assigned to your phone, you may press it at any time, to record the conversation in progress. If you have a display keyset, you will also have the soft key options to pause and time the message.

## SHORTCUTS

### Calling

Calling a station that is busy or does not answer you can press **[#]** to immediately send the call to the called parties mailbox.

### Call Divert to Voicemail

While receiving an incoming (ringing) call, dial **[\*]** to immediately send the caller to your personal voicemail box. This will override the call forward no answer setting.

### Direct Messaging

**[#] + DSS** To make it easy to leave messages for others in your office without having to dial their extension number first, keyset users may simply dial **[#]** plus a mailbox (extension) number and leave a message directly. If you dial a busy extension press **[#]** to connect directly with the mailbox.

### Self Memo (Reminder)

Pressing **##** will leave a message in your own mailbox. This is useful to remind yourself of things to do now or in the future. Messages can be sent with future delivery so you can have the system call you when items become due.

## INTERACTIVE DISPLAYS

Display keyset users have the added advantage of using the soft keys and displays to play, save, delete, reply, call, forward, rewind, pause, fast forward, change the volume, get message information, or help.

### Viewing Mailbox Contents

If you have new messages, in addition to the Terminal Status Indicator (TSI) you will be able to use the keyset displays and soft keys to communicate with the Samsung Voicemail.

## E-MAIL GATEWAY (EMG)

The E-Mail Gateway feature integrates your voicemail box with your email client. No matter what email client software you are using or where you use it, you can send voicemail messages and fax mail messages to your E-Mail inbox.

There are two parts to the E-Mail Gateway; E-Message Delivery and E-Message Notification.

1. **E-MESSAGE DELIVERY:** Voicemail messages (.wav) and/or fax mail messages (.tiff) are "delivered" to your Inbox with the appropriate attached file.
2. **E-MESSAGE NOTIFICATION:** You will receive an e-mail, with NO attachments, notifying you that you have a voice and/or fax mail message in your Voicemail Box.
  - As a subscriber you can use either E-Message Delivery and/or E-Message Notification.
  - As a subscriber you can have multiple e-mail addresses. (a maximum of 5 valid email addresses).
  - E-Message Notification can be set to one e-mail address while E-Message Delivery is set to different e-mail address.

## Functionality

- With either type of EMG, when Caller ID (CID) is provided, the callers telephone number will appear in the subject field of the email along with the date and time stamp of when the voice message was originally recorded in your Voicemail Box.
- If the caller is also a subscriber on the system and the E-Mail Gateway is set up with a valid "Reply To" address, the Subscriber's name will also appear in the "From" field. Otherwise, the "From" field will display the name of the Samsung voicemail system sending the message.
- Client will use their PC's Multi-Media kit (equipped with either speakers and/or a headset) to listen to messages delivered to their e-mail Inbox.

**IMPORTANT NOTE:** If the PC/Laptop/PDA/Smart Phone/etc... is not equipped with hardware and software capable of playing a '.WAV' file then the E-Mail Gateway will not work for them until they add some method to listen to '.WAV' files delivered to their Inbox.

The same applies to Fax Mail messages, if the device the subscriber is using does not support the viewing of '.TIFF' files, then the E-Mail Gateway for Fax Mail will not work for them until they add some method to view .tiff files delivered to their inbox.

- No Synchronization of messages is performed between the Voicemail Box and the E-mail Inbox.
  - Messages listened to, forwarded, deleted, and/or saved within an e-mail inbox will NOT effect the status of that same new message in the Voicemail or the MWI (Message Waiting Indicator) associated with that message on the phone.
  - Also messages listened to in the Voicemail, from a phone, will not change the Unread/Read status of the same message in an e-mail inbox.

- However, the Voicemail Administrator can adjust parameters per subscriber or group of subscribers that decide how, when, or if to delete the original voice message after it is sent to the E-Mail Server.
- When full synchronization of messages between Voicemail Box and E-mail Inbox is required, ask your Samsung representative about the OfficeServ IP-UMS. This is an Internet Protocol based fully synchronized Unified Messaging System.

## Benefits

- Store and Archive Voice and Fax Mail Messages in visible folders.
- Voice and Fax Mail Messages can now easily be dragged and dropped into folders the same way e-mail messages are organized and saved.
- Voice and Fax Mail Messages are now essentially the same as any other e-mail message.
- Backups and Message Archives can be made when they are made for all other types of e-mail messages.
- Add text notes and comments to use for reference later.
- Some (if not all) e-mail clients will allow you to edit the body of the e-mail to add comments.
- Some will allow you to edit the subject field to help you find a particular message quickly in a large archive of messages.
- Call Back Numbers and Date & Time Stamp are easily displayed in the Subject field.
- Easily forward Voice messages received, to others even if they are not a Voicemail Subscriber on your system.
- No EMG System or Client Software to load on your Local PC or Network Servers.

Therefore compatible with most:

- E-Mail providers and E-Mail Clients
- PCs, Laptops, PDA, and/or Smartphones

**NOTE:** If you are not sure you have this functionality on your system and you would like to use it, please contact your on Site system administrator to see if it is available.



## PERSONAL SPEED DIAL NUMBERS

CODE	NAME	TELEPHONE NUMBER
00	_____	_____
01	_____	_____
02	_____	_____
03	_____	_____
04	_____	_____
05	_____	_____
06	_____	_____
07	_____	_____
08	_____	_____
09	_____	_____
10	_____	_____
11	_____	_____
12	_____	_____
13	_____	_____
14	_____	_____
15	_____	_____
16	_____	_____
17	_____	_____
18	_____	_____
19	_____	_____
20	_____	_____
21	_____	_____
22	_____	_____
23	_____	_____
24	_____	_____

## PERSONAL SPEED DIAL NUMBERS

CODE	NAME	TELEPHONE NUMBER
25	_____	_____
26	_____	_____
27	_____	_____
28	_____	_____
29	_____	_____
30	_____	_____
31	_____	_____
32	_____	_____
33	_____	_____
34	_____	_____
35	_____	_____
36	_____	_____
37	_____	_____
38	_____	_____
39	_____	_____
40	_____	_____
41	_____	_____
42	_____	_____
43	_____	_____
44	_____	_____
45	_____	_____
46	_____	_____
47	_____	_____
48	_____	_____
49	_____	_____

# Features & Specifications

## Line Groups

9 Local/LCR  
 800 \_\_\_\_\_  
 801 \_\_\_\_\_  
 802 \_\_\_\_\_

## Station Groups

501 \_\_\_\_\_  
 502 \_\_\_\_\_  
 503 \_\_\_\_\_  
 504 \_\_\_\_\_

## Paging Zones - Dial 55 plus

0 \_\_\_\_\_  
 1 \_\_\_\_\_  
 2 \_\_\_\_\_  
 3 \_\_\_\_\_  
 4 \_\_\_\_\_  
 5 \_\_\_\_\_  
 6 \_\_\_\_\_  
 7 \_\_\_\_\_  
 8 \_\_\_\_\_  
 9 All External Zones  
 \* All External Zones and Internal Zone 0

## Programmed Messages

01 In A Meeting  
 02 Out On a Call  
 03 Out To Lunch  
 04 Leave A Message  
 05 Page Me  
 06 Out Of Town  
 07 In Tomorrow  
 08 Return Afternoon  
 09 On Vacation  
 10 Gone Home  
 11 \_\_\_\_\_  
 12 \_\_\_\_\_  
 13 \_\_\_\_\_  
 14 \_\_\_\_\_  
 15 \_\_\_\_\_  
 16\* \_\_\_\_\_  
 17\* \_\_\_\_\_  
 18\* \_\_\_\_\_  
 19\* \_\_\_\_\_  
 20\* \_\_\_\_\_

## Feature Access Codes

10 + xxx Pick Up A Parked Call  
 12 + xxx Pick Up A Held Call  
 13 Door Lock Release  
 16 + xxx Speed Dialing  
 17 Save And Redial Number  
 18 New Call (Recall)  
 19 Last Number Redial  
 400 Cancel Do Not Disturb  
 401 Set Do Not Disturb  
 42 + xxx Cancel Message You Left  
 43 Return Message  
 44 Callback  
 45 Busy Station Camp-On  
 46 Conference  
 47 Account Code  
 48 + xx Cancel Programmed MSG  
 49 Send Flash To C.O. or PBX  
 56 Meet Me Answer  
 600 Cancel All Call Forward  
 601 + xxx Set Forward All Calls  
 602 + xxx Set Forward Busy  
 603 + xxx Set Forward No Answer  
 604 + xxx Set Fwd Busy/No Answer  
 605 + xxx Set Forward on DND  
 606 + xxx Set Forward Follow Me  
 65 + xxx Pick Up Ringing Extension  
 66 + xx Pick Up Group  
 67 Universal Answer  
 \* Authorization Code

\*Programmed Messages 16~20 not available on OS 7030, 7100, and 7200-S.

**OfficeServ™**

iDCS Keypad  
User Guide



## **iDCS KEYPAD USER GUIDE**

for  
OfficeServ™ 100, OfficeServ™ 500 and  
OfficeServ™ 7000 Series

*December 2009*

Samsung Telecommunications America reserves the right without prior notice to revise information in this guide for any reason. Samsung Telecommunications America also reserves the right without prior notice to make changes in design or components of equipment as engineering and manufacturing may warrant. Samsung Telecommunications America disclaims all liabilities for damages arising from the erroneous interpretation or use of information presented in this guide.

# TABLE OF CONTENTS

<b><u>ABOUT THIS BOOK</u></b> .....	1
<b><u>THINGS YOU SHOULD KNOW</u></b> .....	2-10
<b><u>ASSEMBLING YOUR KEYSET</u></b> .....	11
<b><u>ADDING AN iDCS 14B KEY STRIP</u></b> .....	12
<b><u>ADDING A KEYSET DAUGHTERBOARD MODULE</u></b> .....	13
<b><u>OUTSIDE CALLS</u></b>	
<u>Making an Outside Call</u> .....	14
<u>Answering an Outside Call</u> .....	14
<u>Universal Answer</u> .....	14
<u>Recall/Flash</u> .....	15
<u>Busy Line Queuing with Callback</u> .....	15
<u>Canceling Callback</u> .....	15
<b><u>INTERCOM CALLS</u></b>	
<u>Calling Other Stations</u> .....	16
<u>Answering Intercom Calls</u> .....	16
<u>Answer Modes</u> .....	16
<u>Busy Station Callback</u> .....	17
<u>Busy Station Camp-on</u> .....	17
<u>Calling Your System Operator</u> .....	18
<b><u>CALL PROCESSING</u></b>	
<u>Holding Calls</u> .....	19-20
<u>Transferring Calls</u> .....	20-21
<u>Transfer with Camp-On</u> .....	21
<u>Transfer to Voicemail</u> .....	21
<u>Call Waiting</u> .....	21
<u>Conference Calls</u> .....	22

Copyright 2006-2009 Samsung Telecommunications America.

All rights reserved. No part of this manual may be reproduced in any form or by any means—graphic, electronic or mechanical, including recording, taping, photocopying or information retrieval systems—without express written permission of the publisher of this material.

Forwarding Calls.....	23–25
Call Pickup .....	25
My Group Pickup .....	25
Privacy Release .....	26

## **DIALING FEATURES**

Speed Dialing .....	27
Programming Personal Speed Dial Numbers .....	27–28
One Touch Speed Dialing.....	28
Last Number Redial .....	28
Manual Retry with Redial .....	29
Save Number with Redial .....	29
Chain Dialing.....	29
Automatic Redial/Retry .....	29
Pulse to Tone Changeover .....	30
Memo Redialing.....	30

## **PAGING AND MESSAGING**

Making an Internal Page.....	31
Making an External Page .....	31
All Page .....	31
Meet Me Page.....	32
Call Park and Page.....	32
Messages—Set and Cancel .....	33
Returning Messages .....	33
Programmed Messages.....	34

## **CONVENIENCE FEATURES**

Do Not Disturb .....	35
One Time DND .....	35
Mute .....	35
Background Music .....	35
Established Call Pick-Up .....	36
Appointment Reminder/Alarm Clock .....	36
Door Phone Calls .....	37
Executive/Secretary Hotline .....	37
Executive Divert .....	37
Group Listening .....	38
Account Codes .....	38

Locking Your Keypad .....	39
Manual Signalling .....	39
Off-Hook Voice Announce .....	39–40
OHVA Block .....	40
OHVA Reject .....	40
In Group/Out of Group .....	40–41

## **CUSTOMIZING YOUR KEYPAD**

AME Password .....	42
Auto Camp-On .....	42
Select Ring Tone .....	42
Change Your Passcode .....	42
Set Answer Mode (Intercom) .....	43
Set Answer Mode (CO) .....	43
Automatic Hold .....	43
Headset Operation .....	43
Hot Keypad .....	44
Key Confirmation Tone .....	44
Rejoining a Page .....	44
Ring Preference .....	44
Auto Answer CO Calls .....	45
Display Speed Dial Name .....	45
Caller ID Review All .....	45
Secure OHVA .....	45
Configure Mobile Extensions (MOBEX).....	46

## **DISPLAY FEATURES**

Interactive Display Keys .....	47
Directory Information .....	47
Call Log .....	48
Dial by Name.....	48
Call Progress Displays .....	49
Display Number Dialed .....	49
Call Duration Timer.....	49
Auto Timer .....	49
Timer Function .....	49
Viewing Message Indications .....	50
Alarm Reminder Messages.....	50–51
Personal Speed Dial Names.....	51
Station Names .....	51

<a href="#">Managing Key Assignments</a>	52
<a href="#">LCR with Clear</a>	52
<a href="#">Backspace with LCR</a>	52
<a href="#">Text Messaging</a>	53–54
<a href="#">Caller ID</a>	55–59
<a href="#">ANI</a>	56–59
<a href="#">CLI</a>	56–59

## [iDCS 64B MODULE WITH KEYSSET](#) .....60

### [Samsung Voicemail](#) .....61

<a href="#">Subscriber Services Menu Diagram</a>	62–63
<a href="#">Accessing your Mailbox</a>	64
<a href="#">Getting Started</a>	65
<a href="#">Listen to your Messages</a>	65
<a href="#">Subscriber Services Menu</a>	65
<a href="#">Listening to Old or New Messages</a>	66
<a href="#">Group New or Old Messages</a>	67
<a href="#">Record and Send a Message</a>	67
<a href="#">Access Manager</a>	68
<a href="#">Personal Greetings</a>	70
<a href="#">Mailbox Administration</a>	72
<a href="#">Message Broadcast</a>	74
<a href="#">Personal Services</a>	75
<a href="#">Personal Administration Settings</a>	76
<a href="#">Keypad User Features</a>	77
<a href="#">Shortcuts</a>	79
<a href="#">Interactive Displays</a>	79
<a href="#">E-Mail Gateway (EMG)</a>	79–81

## [PERSONAL SPEED DIAL NUMBERS](#) .....82–83

## ABOUT THIS BOOK

Your iDCS keyset is the most visible part of your telephone system. No matter what model keyset you are using telephone calls are handled the same way. The 28D and 18D keysets have additional conveniences that are not available to 8D keyset users. These are noted throughout this guide.

Please take the time to study this guide and to become familiar with the operation of your keyset. Keep this guide handy. You may need to look up instructions for infrequently used features.

Learning to use your keyset correctly will make everyday telephone communications a breeze.

This book is written based on the factory default settings for the feature access codes. Sometimes, due to programming requirements, these codes may be changed. If you find that a feature code does not work as described in this book, please contact your installation and service company to determine the correct code.

# THINGS YOU SHOULD KNOW

## USER ORIENTATION

iDCS telephones are called “keysets.” They contain buttons or “keys” that are used to access or activate the many features of your office phone system. The keys with paper designation strips are programmable keys. This means they can be programmed for a specific function on your keyset and that same button can be something different on another keyset. See the system manager to get your most frequently used features assigned to your programmable keys. When changes are made, be sure that your programmable keys are relabeled properly.

Lines from the telephone company are “C.O. lines.” Calls on these lines are referred to as “outside calls.” Your system can have individual C.O. line keys or lines may be assigned to groups. When they are in a group, you access a line by dialing an access code or pressing a route button. For example, dial 9 or press a “LOCAL” key to get a local outside line. If Least Cost Routing is used, pressing the “LCR” key will automatically select a preprogrammed C.O. line according to what digits are dialed. Each line in the system is numbered, beginning with 701, then 702, 703, etc.

Direct Station Selection (DSS) keys are programmed to ring specific stations. You can press a DSS key instead of dialing the extension number. A DSS key lights red when that station is busy (Busy Lamp Indication).

iDCS keysets provide distinctive ring patterns:

- Outside calls have a single ring tone repeated.
- Internal calls have a double ring tone repeated.
- Door phone calls and alarm/appointment reminders have a triple ring tone repeated.

## CALL INDICATIONS

The keys on your phone have light emitting diodes (LEDs). These are tri-colored LEDs that light green, red or amber (green and red together).

Intercom calls, also called internal calls, always appear on your CALL buttons. They will always light green. You can have up to eight CALL buttons, but at least two are recommended.

Outside calls appear on individual line keys if they are assigned. When an individual line is not assigned to its own key, it will appear on a CALL button.

Your outside calls will light green on your keyset and red on other keysets. You never lose sight of your calls while they are on hold. They stay right where you put them and are identified with a green flashing light.

Some simple rules to remember:

- Any steady LED indicates the line or feature is in use.
- A fast flashing green LED indicates a new call ringing in.
- A slow flashing green or red LED indicates a call is on hold.
- A slow flashing amber LED indicates a recall to your keyset.

## SPEAKERPHONE

All iDCS keysets are speaker phones. Pressing the **ANS/RLS** key will answer or release a call on the speakerphone. Switching from the handset to the speakerphone is easy. Press the **SPEAKER** key and hang up the handset.

## VOLUME CONTROLS

The iDCS keysets use the UP and DOWN keys to adjust the ringer volume while the keyset is ringing, the speaker volume while the speakerphone is in use and the handset volume while you are listening. These three levels will be stored in memory until changed. If background music is turned on at your keyset, the volume keys will also control the level of music. The volume of pages heard through the speaker of a keyset can be adjusted during a page announcement by using the volume keys. There are 16 levels for each volume setting. The volume of off-hook ring is controlled by a user-programmable setting.

## TERMINAL STATUS INDICATOR

The terminal status indicator light is positioned on the top right corner of the keyset above the display. The terminal status indicator is a tri-colored (red, green, and amber) light that provides greater visibility of your keysets status than the individual key LEDs. The terminal status indicator provides the following indications:

- |                     |                                      |
|---------------------|--------------------------------------|
| • Busy/Off Hook     | Steady Red                           |
| • Intercom Ring     | Flashing Red                         |
| • Outside Call Ring | Flashing Green                       |
| • Recall Ring       | Flashing Amber                       |
| • Message Waiting   | Flashing Red                         |
| • Do Not Disturb    | Fast Flash Red at 1 Second Intervals |

## FEATURE ACCESS CODES

This user guide is written based on the default access code for using system features. If the system numbering plan has been changed some of the access codes may not be correct. Your installing company can inform you of the correct codes.

## SYSTEM TONES

The system provides several tones to assist you. Some of these tones are already familiar to you.

Intercom Dial Tone—A steady tone that indicates you can begin dialing.

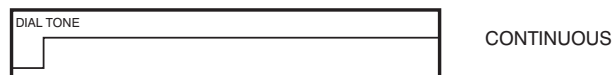

Ringback Tone—Indicates the station you dialed is ringing.



Busy Tone—Indicates the station you dialed is busy.



DND/No More Calls Tone—Fast busy tone indicates the station you dialed is in the Do Not Disturb mode or cannot receive any more calls.

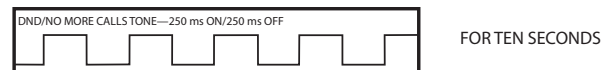

Transfer/Conference Tone—Indicates your call is being held and you can dial another party.

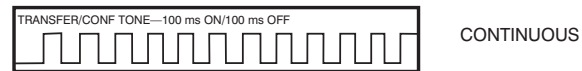

Confirmation Tone—Very short beeps followed by dial tone indicate you have correctly set or canceled a system feature.



Error Tone—A distinctive two level beeping tone indicates you have done something incorrectly. Try again.



## iDCS 28D KEYSET

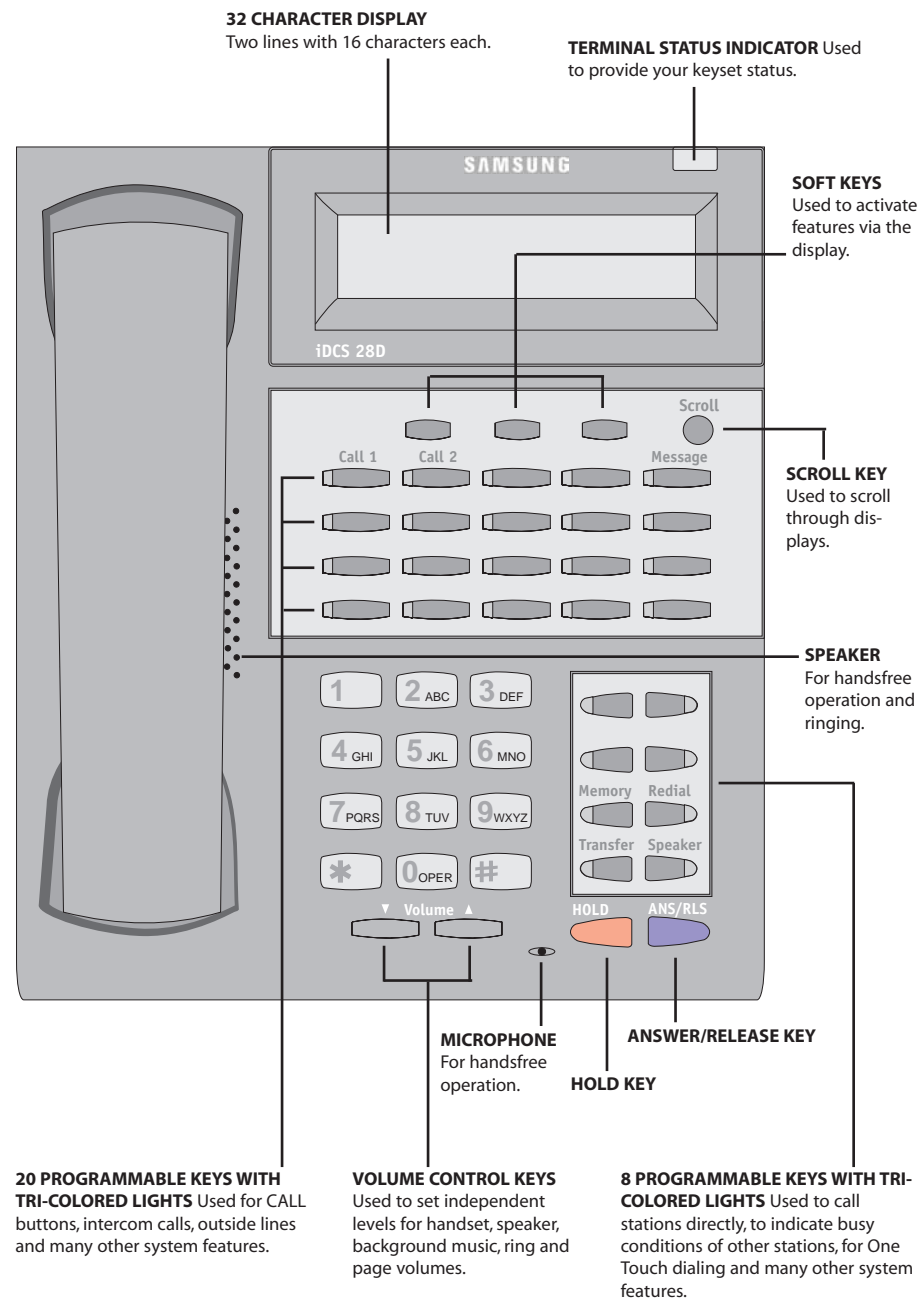



# iDCS 18D KEYSSET

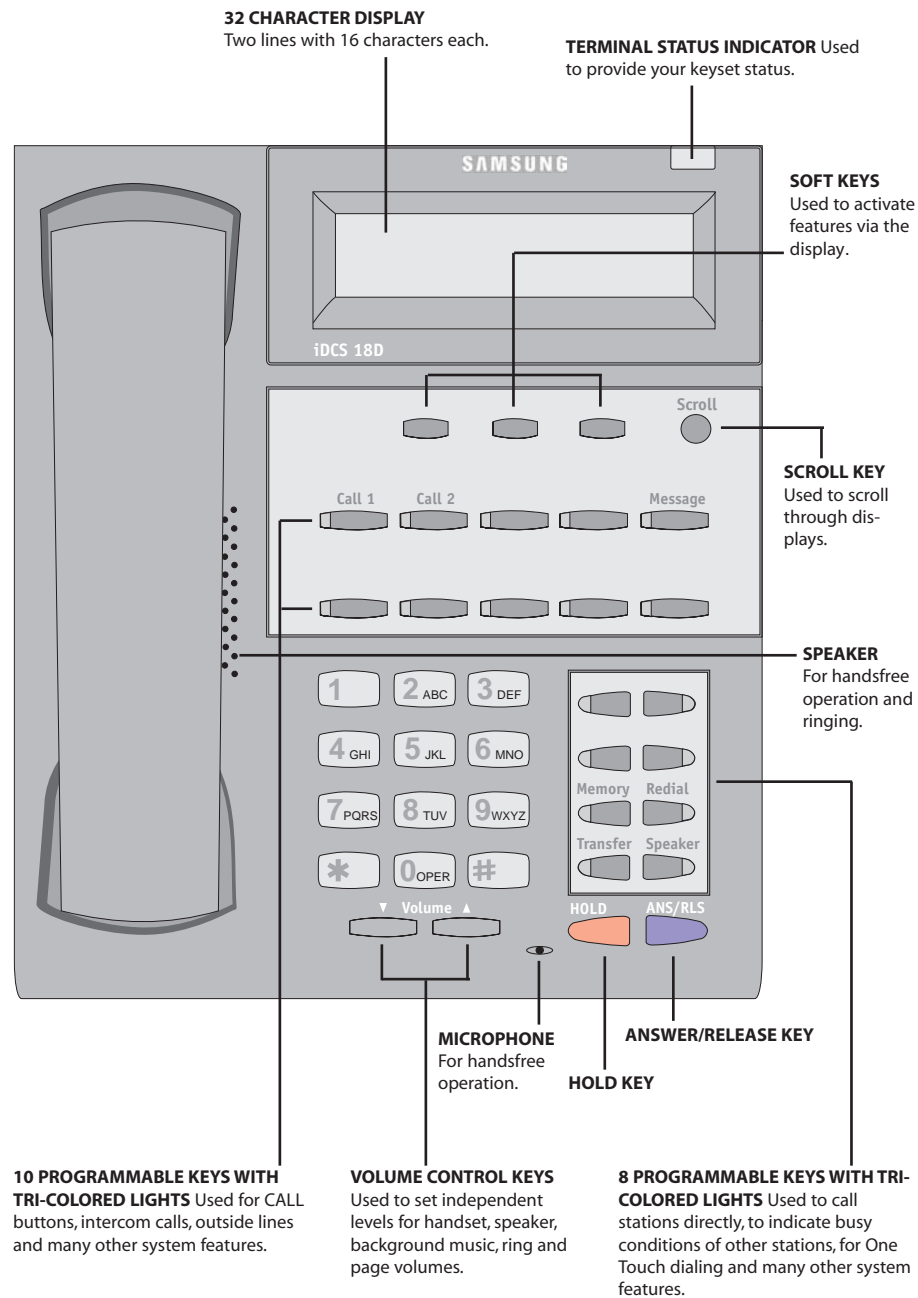

# iDCS 8D KEYSSET

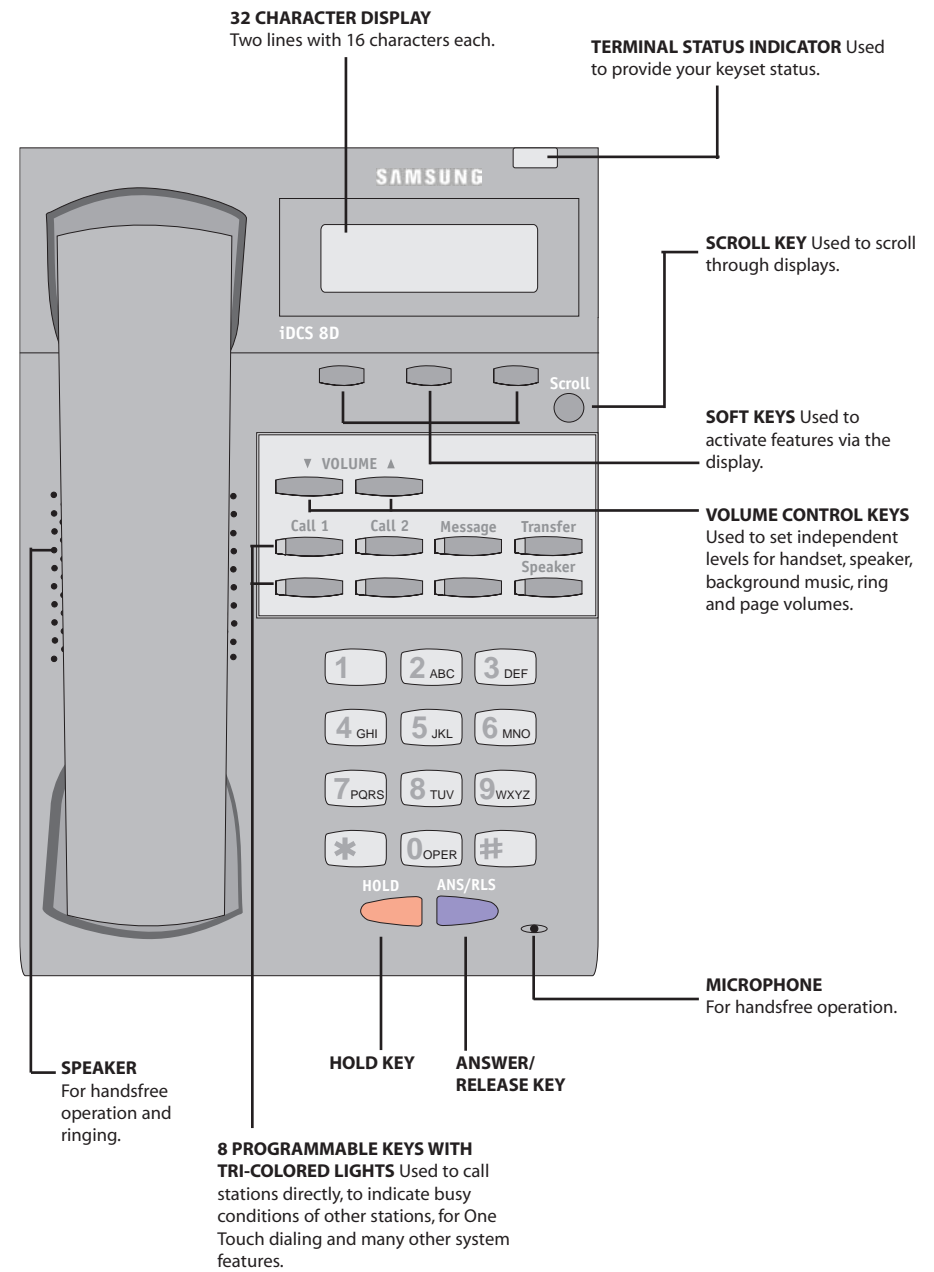

# iDCS 64B AOM

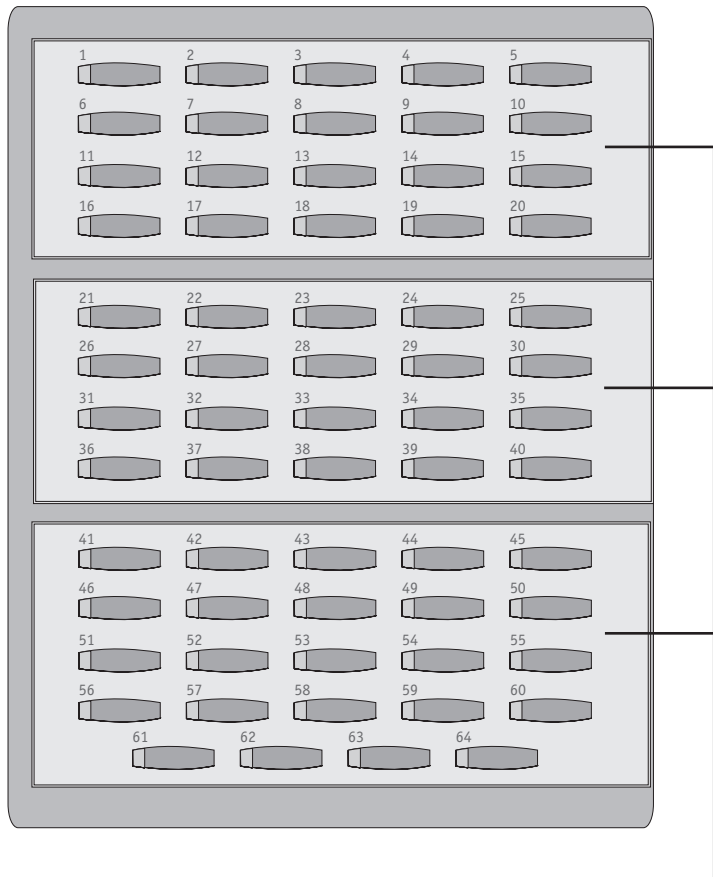

**64 PROGRAMMABLE KEYS WITH RED LIGHTS** Used to call stations directly, to indicate busy conditions of other stations, for One Touch dialing and many other system features.

# iDCS 14B STRIP

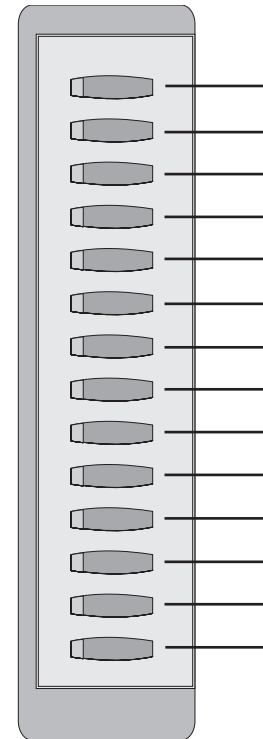

**14 PROGRAMMABLE KEYS WITH RED LIGHTS** Used to call stations directly, to indicate busy conditions of other stations, for One Touch dialing and many other system features.

## KEYSET DAUGHTER MODULES

[28 AND 18 BUTTON KEYSETS ONLY]

iDCS 28D and 18D button keysets can have one of three different types of daughter module installed on them to enhance the operation of the keyset or to provide an additional local port depending on the type of module.

### iDCS KDB-DIGITAL LINE INTERFACE

**(FKDBD)** [NOT SUPPORTED ON OS 7030, OS 7100, 7200-S]



If your keyset is connected to a Digital Line Interface (DLI) port that supports 2B+D operation (your installing company can determine this) you may install a daughter module that provides a Digital Line Interface (DLI) port for connection of a digital station device such as a keyset or 64 button module.

### iDCS KDB-SINGLE LINE INTERFACE

**(FKDBS)** [NOT SUPPORTED ON OS 7030, OS 7100, 7200-S]

If your keyset is connected to a Digital Line Interface (DLI) port that supports 2B+D operation (your installing company can determine this) you may install a daughter module that provides a Single Line Interface (SLI) port for connection of a standard telephone device such as a cordless phone. [NOT SUPPORTED ON OfficeServ 7030, OfficeServ 7100 or OfficeServ 7200-S]

## ASSEMBLING YOUR KEYSET

- Place the keyset face down on a flat surface.
- Remove the base pedestal by placing your thumbs over the attachment clips and press outward while simultaneously pressing down on the keyset body with your fingertips.
- Plug the handset cord into the jack marked with the  symbol.
- Route the handset cord out the RIGHT side of the keyset as you look at it face down.
- Reattach the base pedestal.
- Plug the line cord into the jack on the base of the keyset marked with the  symbol and route it through one of the cable channels in the bottom of the base pedestal.

## ADDING AN iDCS 14 BUTTON KEY STRIP

- Place the keyset face down on a flat surface.
- Remove the base pedestal by placing your thumbs over the attachment clips and press outward while simultaneously pressing down on the keyset body with your fingertips.
- Remove the ribbon cable knockout from the bottom of the keyset.
- Clip the 14 button strip to the side of the keyset.
- Plug one end of the ribbon cable into the keyset and the other end into the 14 button strip.
- Place the support bracket over the ribbon cable and secure with the six screws provided.
- Reattach the base pedestal.

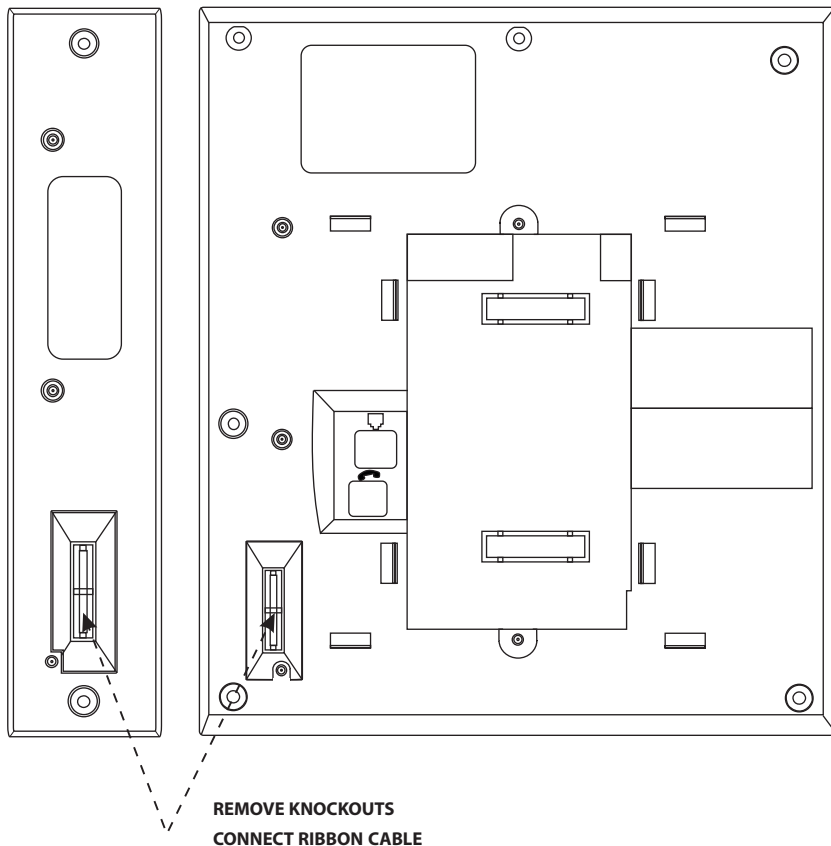

## ADDING A KEYSET DAUGHTERBOARD MODULE

- Place the keyset face down on a flat surface.
- Remove the base pedestal by placing your thumbs over the attachment clips and press outward while simultaneously pressing down on the keyset body with your fingertips.
- Remove the two knockouts from the bottom of the keyset.
- Plug in the daughter module and secure with the two screws provided.

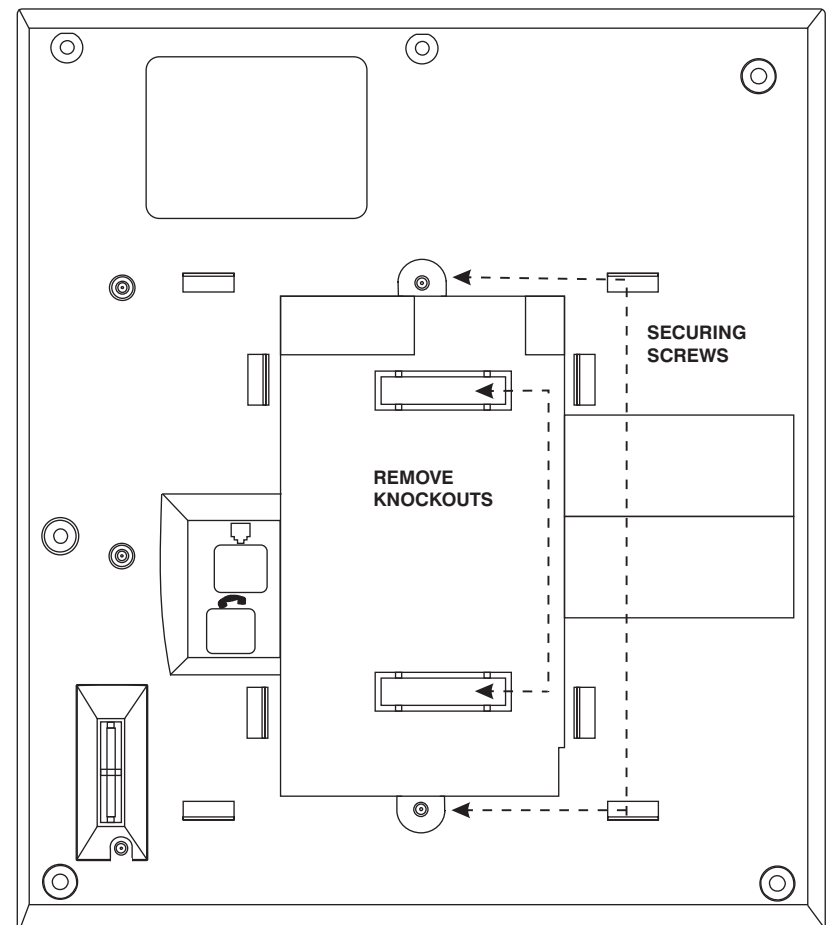

# OUTSIDE CALLS

## MAKING AN OUTSIDE CALL

- Lift the handset and press an idle outside line button, line group button or dial a line access code to receive dial tone—**OR**—press an idle outside line button, line group button or dial a line access code to receive dial tone through the speaker—**OR**—press **SPEAKER**, receive intercom dial tone and dial a line access code.
- Dial the telephone number.
- Finish the call by replacing the handset or pressing the **ANS/RLS** key.

NOTE: You will receive No More Calls tone when you attempt to make a call and there is no key available for that line.

- If Least Cost Routing is enabled on your phone system, this button may be labeled **LCR** or accessed by dialing an access code (usually **9**).
- If your system is programmed to require an authorization code before making a call, dial **\*** plus a valid code before selecting a C.O. line.
- If your system is programmed to require an account code before making a call, press the **ACC** button or dial **47** plus a valid bin number, press the **ACC** button again, or **\***, and then select a C.O. line. [See Account Codes for more information.](#)

For more information on authorization and account codes, see your system administrator.

NOTE: If the Hot Keypad feature has been turned off, you must first lift the handset or press the **SPEAKER** key before dialing.

## ANSWERING AN OUTSIDE CALL

- Lift the handset and you are automatically connected to the ringing call. [See Ring Preference under Customizing Your Keypad](#)—**OR**—press the **ANS/RLS** key to automatically answer on the speakerphone.

NOTE: If a call is flashing at your keyset but not ringing, you must press the flashing button to answer.

## UNIVERSAL ANSWER

Outside lines may be programmed to ring a general alerting device. To answer calls ringing this device, dial **67** or press the **UA** key. This device can operate in any one of the six different ring plans.

NOTE: If the Hot Keypad feature has been turned off, you must first lift the handset or press the **SPEAKER** key before dialing.

## RECALL DIAL TONE

Press the **NEW** button to disconnect your existing call, wait for dial tone and then make a new call on the same line.

NOTE: If this button does not appear on your keyset, the **FLASH** key may be programmed to recall dial tone.

## SENDING A FLASH

While on an outside call, press the **FLASH** key to send a flash to the telephone company. This is required for some custom calling features or CENTREX use.

NOTE: Flash is not available on an ISDN circuit.

## BUSY LINE QUEUING WITH CALLBACK

If you receive a busy signal when you are selecting an outside line, this means that the line or group of lines is busy.

- Press the **CBK** key, if programmed, or dial **44**. You will hear confirmation tone.
- When the line becomes free, the system will call you back.
- Lift the handset or press the **ANS/RLS** key to answer, wait for dial tone and dial the telephone number or speed dial number again.

NOTES:

1. A callback will be canceled if not answered within 30 seconds. If you have set a callback, your **CBK** key will light.
2. If the Hot Keypad feature has been turned off, you must first lift the handset or press the **SPEAKER** key before dialing.

## CANCELING CALLBACK

A callback will be canceled if not answered within 30 seconds. If you have set a callback, your **CBK** key will light.

Your phone may have a maximum of five callbacks to lines and/or stations set at a time. To cancel a callback:

- Press the **CBK** key, if programmed, or dial **44**. You will hear confirmation tone.
- While you are listening to confirmation tone, press the **HOLD** key. This will cancel the oldest set callback.

NOTES:

1. If the hot keypad feature is turned off, you must first lift the handset or press the **SPEAKER** key before dialing.

# INTERCOM CALLS

## CALLING OTHER STATIONS

- Dial the extension number or group number.
- Wait for the party to answer. If you hear a brief tone burst instead of ringback tone, the station you called is set for Voice Announce or Auto Answer. Begin speaking immediately after the tone.
- Finish the call by replacing the handset or pressing the **ANS/RLS** key.

### NOTES:

1. If you have a **DSS** key assigned to an extension or station group, you may press this key instead of dialing the number.
2. If the Hot Keypad feature has been turned off, you must first lift the handset or press the **SPEAKER** key before you begin dialing.

## ANSWERING INTERCOM CALLS

- When your keyset rings, simply lift the handset—**OR**—press the **ANS/RLS** key to be connected to the calling station.
- Finish the call by replacing the handset or pressing the **ANS/RLS** key.

[See Ring Preference under Customizing Your Keypad.](#)

## VOICE ANNOUNCE MODE

When another station calls you, your keyset will sound a brief attention tone and you will hear the caller's announcement.

- Press **ANS/RLS** to turn on the microphone and speak handsfree—**OR**— lift the handset to reply.
- To finish the call, replace the handset or press the **ANS/RLS** key.

NOTE: In order for C.O. calls to be answered handsfree, AUTO ANS CO must be set ON.

## AUTO ANSWER MODE

When another station calls you, your keyset will sound a brief attention tone and then automatically answer the call.

- Your microphone and speaker are turned on and you can speak handsfree. For privacy, use the handset.
- To finish the call, replace the handset or press the **ANS/RLS** key.

NOTE: In order for C.O. calls to be answered handsfree, AUTO ANS CO must be set ON.

## BUSY STATION CALLBACK

When you call another station and receive a busy signal:

- Press the **CBK** key, if programmed, or dial **44**.
- When the busy station becomes free, your keyset will ring.
- Lift the handset or press **ANS/RLS** to call the now idle station.

### NOTES:

1. A callback will be canceled if not answered within 30 seconds. If you have set a callback, your **CBK** key will light.
2. If the Hot Keypad feature has been turned off, you must first lift the handset or press the **SPEAKER** key before dialing.

## BUSY STATION CAMP-ON

When you call another station and receive a busy signal but you do not want to wait for a callback:

### MANUAL CAMP-ON

- Press the **CAMP** key or dial **45**.
- The called station will receive off-hook ring tone repeated every few seconds and its first available **CALL** button will flash green to indicate your call is waiting.
- Wait for the called party to answer.
- The called station must release its first call or place it on hold before answering your camp-on.

### NOTES:

1. If you receive No More Calls tone, that station has no available key to accept your call. Hang up or leave a message.
2. If the Hot Keypad feature has been turned off, you must first lift the handset or press the **SPEAKER** key before dialing.

### AUTO CAMP-ON

When you want to automatically camp on to a busy station without pressing the camp on button every time you call a busy station, you can set your phone for auto camp-on.

- With the handset on-hook, press **TRANSFER** and then dial **110**.
- Dial **081** to turn on auto camp-on or **080** to turn it off.
- Press **TRANSFER** to store your selection.

## CALLING YOUR SYSTEM OPERATOR

- Dial **0** to call your system operator or group of operators.
- If you want to call a specific operator, dial that person's extension number.

NOTE: If the Hot Keypad feature has been turned off, you must first lift the handset or press the **SPEAKER** key before you begin dialing.

## CALL PROCESSING

### SYSTEM HOLD

- When you are connected to any call, press **HOLD**. The call will flash green at your keyset. If this call appears on a line key at other keysets, it will flash red at those keysets.
- To take the caller off hold, press that key and the green flashing light will go steady green again. Resume the conversation.

NOTE: While on a call, pressing a line key, route key or flashing **CALL** button will automatically put your first call on hold and connect you to the new call. [See Automatic Hold under Customizing Your Keypad.](#)

### EXCLUSIVE HOLD

To place an outside call on hold at your phone so that other users cannot get it:

- Press the **HOLD** button twice. The call will flash green on your keyset and this line will show a steady red light on other keysets.
- To retrieve the call, press the flashing green line button or press the **HOLD** button a third time.

NOTE: Intercom calls will always be placed on exclusive hold.

### REMOTE HOLD

When you wish to place a call on hold at another station. Press **TRANSFER** and dial the station number (or press the appropriate DSS key). Press the **HOLD** key. This will place the call on system hold on an available CALL button or Line Key at the remote station and return you to dial tone.

NOTES:

1. If the destination station does not have any free CALL buttons or line keys you will hear No More Calls tone and must return to the other party by pressing the **TRANSFER** key (or the RETURN soft key in the display).
2. Intercom calls cannot be remote held.

### HOLD RECALL

If you leave a call on hold longer than the hold timer, it will recall your station. The button that the call appears on will have a slow flashing amber light.

- When your phone rings, lift the handset or press the **ANS/RLS** key to answer the recall.

- If you do not answer this recall within a pre-programmed period of time, it will go to the system operator.

## CONSULTATION HOLD

When you are talking on an outside line and it is necessary to consult with another extension:

- Press the **TRANSFER** key; you will receive transfer dial tone. Your call is placed on transfer hold.
- Dial the extension number.
- Consult with the internal party.
- Press **TRANSFER** to return to the outside party or hang up to transfer the call.

NOTE: Repeatedly pressing the **TRANSFER** key will toggle between the outside party and internal extension. If necessary you may disconnect either one of the parties by pressing the **DROP** button.

## RETRIEVING CALLS HELD AT ANOTHER STATION

When a line is on hold and it appears on your keyset, press the line button with the red flashing light.

When a line is on hold and it does not appear on your keyset, dial **12** plus the line number or the extension number of the station that placed the call on hold.

NOTE: If the Hot Keypad feature has been turned off, you must first lift the handset or press the **SPEAKER** key before you begin dialing.

## TRANSFERRING CALLS

Transfer is used to send any call to another extension in one of two ways. You can do a screened transfer by informing the other extension who is calling or you can do a blind transfer without notification.

- While on a call, press the **TRANSFER** key and dial an extension number or group number. Your call is automatically put on transfer hold. **OR** Press a **DSS** key or station group key. Your call is automatically put on transfer hold.
- Hang up when you hear ringing (this is an unscreened or blind transfer). **OR** Wait for the called party to answer and advise him/her of the call and hang up. If the transfer is refused, you will be reconnected to the outside line when the called station hangs up or you can press **TRANSFER** to return to the outside party. If you wish to send the call to another extension without waiting for the

first station to hang up, simply press another **DSS** button. **OR** Press the **CALL** button or C.O. line key to return to the outside party and begin the transfer process again.

When you are transferring a call to a keyset set for Voice Announce or Auto Answer, the transferred call will always ring.

NOTES:

1. After the inside party answers, you may alternate back and forth between the parties by pressing the **TRANSFER** key.
2. If you receive No More Calls tone, that station has no key available to receive another call. Press **TRANSFER** to return to the other party.
3. You cannot transfer an Intercom call by pressing a DSS key. You must press the **TRANSFER** key and dial the destination extension number.

## TRANSFER WITH CAMP-ON

When you are transferring a call to another station and you receive a busy signal, you may camp the call on to this station. Simply hang up when you hear the busy signal. The called party will be alerted that a call is waiting for them.

NOTE: If you receive No More Calls tone, that station has no key available to receive another call. Press **TRANSFER** to return to the outside caller.

## TRANSFER TO VOICEMAIL

This feature is used to send a call directly to a voice mailbox. Your keyset must have a correctly programmed **VT** key to accomplish this. To transfer a call directly to a voice mailbox:

- While on a call, press the **VT** key and dial the mailbox number.
- Hang up when dialing is completed.

## CALL WAITING

If an outside call has been camped-on to your phone or another station has camped-on to you:

- Your keyset will ring and the call that is waiting for you (camped-on) will flash green.
- Press the flashing button to answer; your other call will go on hold automatically if your station has the Automatic Hold feature set. If not, you must press **HOLD** and then the flashing button. **OR** Finish the first call and hang up; the waiting call will ring.
- Lift the handset or press the **ANS/RLS** key to answer.

NOTE: Intercom calls will not go on Automatic Hold.



## CONFERENCE CALLS

You may conference up to five parties (you and four others) in any combination of outside lines and internal stations in any order.

- While engaged in a conversation, press the **CONF** key and receive conference tone.
- Make another call, either intercom or outside, press the **CONF** key and receive conference tone.
- Make another call or press the **CONF** key to join all parties.
- Repeat the last step until all parties are added.

NOTE: When attempting to add another party to the conference and you are not able to reach the desired person, hang up. Simply press the **CONF** key again to return to your previous conversation.

### To drop a party from your conference call:

- Press **CONF** and dial the extension or line number that is to be dropped.
- Press **CONF** again to reestablish the conference.

NOTE: To leave the conference, hang up. Control is passed to the next internal station. If there are no internal stations and you wish to leave outside lines connected together in a trunk to trunk conference, press the **CONF** key plus the **CALL** button that the call appears on or follow the instructions to drop a party and use your extension number. When they hang up, the lines will release automatically. Press **CONF** to rejoin a trunk to trunk conference.

## CONFERENCE SPLITTING

If you are the controlling party of a conference and your keyset has the Auto Hold feature turned on ([See Customizing Your Keyset](#)) and all of the outside lines involved in the conference appear as buttons on your keyset, you can split the conference into separate calls as follows:

- Press any one of the outside line buttons. That outside line will remain steady green to indicate you are still connected to it. All other outside lines in the conference will be placed on system hold at your keyset. All intercom callers in the conference will be disconnected. You may now speak with each caller privately and transfer them as usual or reestablish another conference.

## FORWARDING CALLS

You may forward your calls to another station, group of stations or an external telephone number. Program a destination for the type of forwarding you want as detailed below. If you have **FWD ALL**, **FWD BUSY** and **FWD NO ANSWER** keys, press one to turn that forward feature on. A steady red light reminds you what forward condition is activated.

You can clear all call forward conditions set at your station by lifting the handset and dialing **600**.

## FORWARD ALL CALLS

To forward all your calls under any condition to another station:

- Dial **601** plus the extension or group number.
- Receive confirmation tone and hang up.

NOTES:

1. If the Hot Keypad feature has been turned off, you must first lift the handset or press the **SPEAKER** key before you begin dialing.
2. The station that receives a Forwarded All call can transfer the call to the forwarded station. This is useful when you are expecting an important call but you do not wish to be disturbed by other calls.
3. When a station user places his/her keyset in Forward All mode and he/she does not have a **FORWARD ALL** key, the **TRANSFER** key will light to indicate Forward All has been set and calls to this station have been transferred elsewhere.

## FORWARD BUSY

To forward calls to another station when you are on the phone:

- Dial **602** plus the extension or group number.
- Receive confirmation tone and hang up.

NOTE: If the Hot Keypad feature has been turned off, you must first lift the handset or press **SPEAKER** before you begin dialing.

## FORWARD NO ANSWER

To forward calls to another station when you do not answer:

- Dial **603** plus the extension or group number.
- Receive confirmation tone and hang up.

NOTE: If the Hot Keypad feature has been turned off, you must first lift the handset or press the **SPEAKER** key before you begin dialing.

## FORWARD BUSY/NO ANSWER

If you have both a Forward on Busy destination and a Forward No Answer destination programmed, you may set both of these at the same time:

- Dial **604**.
- Receive confirmation tone and hang up.

NOTE: If the Hot Keypad feature has been turned off, you must first lift the handset or press the **SPEAKER** key before you begin dialing.

## FORWARD FOLLOW ME

When you want all calls to your extension forwarded to the extension where you are now:

- Dial **604** plus your extension number.
- Receive confirmation tone and hang up.

If you want a specific extension's calls forwarded to your phone (Remote Call Forward):

- Dial **606** plus the desired extension number.
- Receive confirmation tone and hang up.

NOTE: If the Hot Keypad feature has been turned off, you must first lift the handset or press the **SPEAKER** key before you begin dialing.

## FORWARD DND

To forward your phone when you activate DND.

- Dial **605** plus the extension number or group number.
- Receive confirmation tone and hang up.

NOTE: If the Hot Keypad feature has been turned off you must first lift the handset or press the **SPEAKER** key before you begin dialing.

## CALL FORWARD OPTIONS

A display keyset may review or change call forward options and destinations. Call forward access can be done via the keypad or by accessing the keyset display features. To review or change call forward options:

- Press **TRANSFER 102**.  
The display will indicate the current current call forward condition and destination **OR**  
Show **0:FORWARD CANCEL** to indicate no forward is set.

- Dial **0** to cancel current condition **OR**  
Dial **1-5** to select forward type **OR**  
Press **UP** or **DOWN** to select forward type.  
Press the right soft key to move the cursor.
- Dial the destination number (e.g., **202**) **OR**  
Press **UP** or **DOWN** to select the destination  
Press the right soft key to move the cursor
- Dial **1** to set **OR**  
Press **UP** or **DOWN** to select **YES** or **NO**
- Press **TRANSFER** to store and exit

## STATION CALL PICKUP

To pick up (answer) a call ringing at another station, lift the handset and dial **66** plus the extension number of the ringing phone.

If you have a **DP** key assigned with a station number, you only need to press this **DP** key with the flashing light to answer the ringing station.

NOTE: If the Hot Keypad feature has been turned off, you must first lift the handset or press the **SPEAKER** key before you begin dialing.

## GROUP CALL PICKUP

To pick up (answer) a call ringing in any pickup group, lift the handset and dial **66** plus the desired group number or press the flashing **GROUP PICKUP** key if available.

### GROUP NUMBERS

<b>01-10</b>	<b>OfficeServ 7030</b>
<b>01-20</b>	<b>OfficeServ 100, OfficeServ 7100, OfficeServ 7200-S</b>
<b>01-99</b>	<b>OfficeServ 500 M</b>
<b>01-99</b>	<b>OfficeServ 500 L</b>
<b>01-99</b>	<b>OfficeServ 7200 &amp; OfficeServ 7400</b>

NOTES:

1. A group pickup key can have an extender for a specific pickup group.
2. If the Hot Keypad feature has been turned off, you must first lift the handset or press the **SPEAKER** key before dialing the access code.

## MY GROUP PICKUP

If desired, a new access code can be assigned to pickup ringing calls in the same pickup group as you are in. Like "66" above except you do not need to dial the desired group number. See your installation company for the assigned access code. MY GROUP PICKUP: \_\_\_\_\_.

## PRIVACY RELEASE

This feature will allow another station to join in our conversation by releasing privacy on the C.O. from your phone.

### To Release Privacy:

While you are talking on a C.O. line and you wish to have other internal parties (or up to three) join the conversation.

- Press the **PRB** key (the **PRB** key will light steady red). Inform the other party that he/she may now join the conversation.

After the other party (or parties) has joined the conversation and you wish to return privacy to the line so that no one else can join the conversation, press the **PRB** key a second time, the **PRB** key LED will be off.

### To Join a Non-Private Conversation:

When someone has informed you that you can join a conversation:

- Press the **C.O. line** key that he/she has indicated.  
**OR**
- Dial the **C.O. line number** that he/she has indicated.

## DIALING FEATURES

### SPEED DIALING

You can dial a preprogrammed telephone number stored in the system-wide speed dial list of numbers 500–999 or from your personal list of numbers 00–49.

You system may be set for 950 system wide numbers. If so the system speed dial access codes are 050~999 and the station speed dial codes are 000~049.

- With the handset on-hook, press the **MEMORY** key or dial **16**.
- Dial the desired speed dial number.
- The telephone number is automatically dialed for you.

NOTE: If the Hot Keypad feature has been turned off, you must first lift the handset or press the **SPEAKER** key before you begin dialing.

### PROGRAMMING PERSONAL SPEED DIAL NUMBERS

You can program frequently dialed telephone numbers in a personal speed dial list. A station may be assigned up to fifty numbers, **00–49**. See your system administrator to determine the amount assigned to your station.

- While on-hook, press **TRANSFER** and then dial **105**.
- Dial a speed dial number (**00–49**).
- Dial a line or line group access code.
- Dial the telephone number to be stored (24 digits maximum). It can include #, \*, FLASH and PAUSE.
- Press **TRANSFER** to store the number.

NOTE: If the Hot Keypad feature has been turned off, you must first lift the handset or press the **SPEAKER** key before you begin dialing.

28D KEYSET  
18D KEYSET  
DEFAULT  
PROGRAMMING KEYS  
LAYOUT

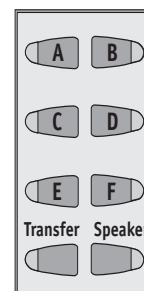

8D KEYSET DEFAULT  
PROGRAMMING  
KEYS LAYOUT

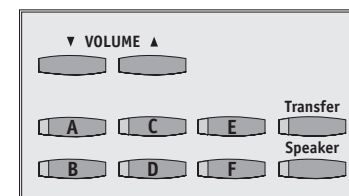

For the purposes of programming speed dial numbers, the programmable keys are known as **A**, **B**, **C**, **D**, **E** and **F** and are defined below.

- The **A** key is not used.
- The **B** key inserts a flash.
- The **C** key inserts a pause.
- The **D** key is used for pulse to tone conversion. If your system uses rotary (or pulse) dialing C.O. lines, pressing **D** while entering a speed dial number causes all subsequent digits to be sent as DTMF tones.
- The **E** key is used to hide digits. Display keyset users may want to hide some speed dial numbers so that they will not show in the display. When you are entering a telephone number, press **E**. All subsequent digits will be hidden. Press **E** again to begin displaying digits.
- The **F** key is used to enter a name. [See \*Personal Speed Dial Names under Display Features.\*](#)
- Use the **HOLD** key to clear a speed dial number.

## ONE TOUCH SPEED DIALING

You may assign any speed dial number to an already existing One Touch Speed Dial button for quick and easy dialing of frequently used numbers.

- While on-hook, press **TRANSFER** and then dial **107**.
- Press a One Touch Speed Dial button.
- Dial the speed dial number (**00–49** or **500–999**) that you want assigned to this button.
- Press **TRANSFER** to store your selection.

To call this telephone number, just press the One Touch Speed Dial button.

NOTE: If the Hot Keypad feature has been turned off, you must first lift the handset or press the **SPEAKER** key before you begin dialing.

## LAST NUMBER REDIAL

To redial the last telephone number you dialed, press the **REDIAL** key or dial **19**.

NOTES:

1. If the Hot Keypad feature has been turned off, you must first lift the handset or press the **SPEAKER** key before you begin dialing.
2. Redial does not apply to intercom calls.

## MANUAL REDIAL WITH REDIAL

While you are on an outside call listening to a busy signal and you want to redial the same number dialed.

- Press the **REDIAL** key.

This will hang up your existing call and manually redial the same number dialed. You can repeat this operation for a limited number of attempts.

NOTE: If your keyset is programmed with Call Log Blocks then the Redial will access the call log when pressed.

## SAVE NUMBER WITH REDIAL

To save the number you just dialed for later use, press the **SNR** key before hanging up.

To redial this saved number at any time, press the **SNR** key or dial **17**. The same line will be selected for you.

NOTES:

1. If the Hot Keypad feature has been turned off, you must first lift the handset or press the **SPEAKER** key before you begin dialing.
2. The saved telephone number is stored in memory until you save another number.
3. Redial does not apply to intercom calls.

## CHAIN DIALING

You may manually dial additional digits following a speed dial number or chain as many speed dial numbers together as required:

- After the first speed number is dialed, press **MEMORY** again and dial another speed number **OR** manually dial additional digits following a speed dial number.

## AUTOMATIC REDIAL/RETRY

When you are making an outside call and you receive a busy signal, the system can automatically redial the number for you. It will automatically redial at a pre-programmed interval for up to 15 attempts.

- When you hear a busy signal, press the **RETRY** button.
- The system will reserve the line and automatically redial the same number for you. You will hear the call being made through the keyset speaker. The microphone is muted.

- When the called party answers, lift the handset or press the flashing **SPEAKER** to begin speaking.

NOTES:

1. If you make another call, auto-redial is canceled.
2. To cancel a retry, lift and replace the handset.

## PULSE TO TONE CHANGEOVER

When making an outside call on a dial pulse line, press #. All digits dialed after the # will be sent as tones.

## MEMO REDIALING

When you are calling directory information, you can store the number you are given using the **SAVE** feature. There is no need for pencil and paper.

- While you are talking on an outside call, press **SAVE**.
- Dial the telephone number as it is dictated to you on the key pad.
- Press **SAVE** to store the number.

To dial the number, press the **SNR** button. It will select the same line and dial the stored number. If necessary, you can select a different line and then press the **SNR** button.

# PAGING AND MESSAGING

## MAKING AN INTERNAL PAGE

To make an announcement through the keyset speakers in the idle condition:

- Lift the handset.
- Press the **PAGE** key or dial **55**.
- Dial the desired zone number **0, 1, 2, 3** or **4**.
- After the attention tone, make your announcement.

NOTES:

1. If you have a dedicated page zone key, it is not necessary to press **PAGE** and dial a zone number.
2. If allowed by your system administrator you may be able to initiate a page from the speakerphone by pressing the **PAGE** key or dialing **55** without lifting the handset.

## MAKING AN EXTERNAL PAGE

To make an announcement through the external paging speakers:

- Lift the handset.
- Press the **PAGE** key or dial **55**.
- Dial the desired zone number **5, 6, 7** or **8 OR** Dial **9** to page all external zones.
- After the attention tone, make your announcement.

NOTES:

1. If you have a dedicated page zone button, it is not necessary to press **PAGE** and dial a zone number.
2. If allowed by your system administrator you may be able to initiate a page from a speakerphone by pressing the **PAGE** key or dialing **55** without lifting the handset.

## ALL PAGE

To page all designated keysets in internal zone 0 and external page zones at the same time:

- Lift the handset.
- Press the **PAGE** key or dial **55**.
- Dial **\*** or press the **ALL PAGE** key.
- After the attention tone, make your announcement.

#### NOTES:

1. The LED on the **PAGE** key will only light when an All Page is in progress.
2. If allowed by your system administrator you may be able to initiate a page from the speakerphone by pressing the **PAGE** key or dialing **55** without lifting the handset.

## MEET ME PAGE

- Lift the handset.
- Press the Meet Me Page (**MMPG**) key or dial **54**.
- Dial the desired zone number.
- After the attention tone, instruct the paged person to dial **56**.
- Press **WAIT** or **TRANSFER**.
- Remain off-hook until the person dials **56** from any phone.
- The paged person will be automatically connected with you.

## CALL PARK AND PAGE

When you have an outside call for someone who is not at his/her desk, you can park the call prior to paging. The iDCS offers two different methods:

#### MANUAL PARK ORBITS

- While in conversation, press the **PARK** button.
- Entered a desired orbit number (**0-9**), if the orbit number is busy dial another orbit number. Display users can press **\*** to automatically place the call in any available orbit number and see the number in the display.
- Remember the selected orbit number.
- Replace the handset when finished.
- Lift the handset and make a page announcement as previously described (example: "John Smith park two").

#### To retrieve a parked call from orbit:

- Press the **PARK** button and dial the announced orbit number (**0-9**).
- You will be connected to the parked call.

#### NOTES:

1. You must have a **PARK** button or park access code to retrieve and place calls in park orbits.
2. If the parked call is not retrieved within a pre-programmed period of time, it will recall your keyset and have a slow flashing amber light. You cannot park and page intercom calls.
3. If the Hot Keypad feature has been turned off, you must first lift the handset or press the **SPEAKER** key before you begin dialing.

#### AUTOMATIC PARK WITH PAGE KEY

- While in conversation, press the **PAGE** button. The call is automatically parked at your station.
- Receive page tone and dial a desired page zone number.
- Make announcement indicating your extension number or the line number. Hang up.

#### To retrieve an automatically parked call:

- Dial **10** plus the number that was announced. If you have a **PAGPK** key, press it and dial the number that was announced. If you have a **PARK** key, press it and dial the announced orbit number.
- You will be connected to the parked call.

#### NOTES:

1. If the call is not retrieved within a pre-programmed period of time, it will recall your keyset and have a slow flashing amber light. You cannot park and page intercom calls.
3. If the Hot Keypad feature has been turned off, you must first lift the handset or press the **SPEAKER** key before you begin dialing.

## SETTING A MESSAGE INDICATION

When you are calling another station and no one answers or you receive a busy signal, you can leave a message indication:

- Press the **MESSAGE** key or dial **43** and receive confirmation tone.
- Hang up. The **MESSAGE** key on the called station will light. Standard telephones receive special dial tone as a message indication or a lit message lamp, if the phone is equipped with one and they are connected to an 8MWSLI card or a 16MWSLI card on the system.

#### NOTES:

1. A station can have up to five message indications.
2. If the Hot Keypad feature has been turned off, you must first lift the handset or press the **SPEAKER** key before you begin dialing.

## CANCELING MESSAGES

To cancel a message indication that you left at another station, dial **42** plus the extension number of the station at which you left a message.

To cancel all message indications left at your keyset, dial **42** plus your extension. Your **MESSAGE** light will go out.

NOTE: If the Hot Keypad feature has been turned off, you must first lift the handset or press the **SPEAKER** key before you begin dialing.

## RETURNING MESSAGES

- Press the **MESSAGE** key or dial **43**. The first station that left a message will be called automatically. If that station does not answer, your **MESSAGE** light will stay on.
- Repeat until all messages have been returned in the order received.
- Your **MESSAGE** light will turn off when all messages have been returned.

### NOTES:

1. Display keyset users can view message indications and return them in any order. [See Viewing Message Indications under Display Features.](#)
2. If the Hot Keypad feature has been turned off, you must first lift the handset or press the **SPEAKER** key before you begin dialing.
3. If a message has been left at your keyset by a keyset in Auto Answer, you must manually cancel the message after it has been returned.

## PROGRAMMED MESSAGES

When you will be away from your phone for any length of time, you can leave a programmed station message. Display stations calling you will see this message and be informed of your status or follow your instructions.

- Dial **48** plus any of the message codes (**01–20**) listed on the back of this user guide.
- To cancel any of these messages you might have selected, dial **48** plus **00**.
- Press **TRANSFER** to exit and store your selection.

NOTE: If the Hot Keypad feature has been turned off, you must first lift the handset or press the **SPEAKER** key.

You can have multiple programmed message keys (**PMSG**) and each one can have a different message code:

- Press any programmed message (**PMSG**) button. The message is set and the button will light red. Press the button again to turn off.
- Pressing another programmed message (**PMSG**) button will turn the previous one off and set a different programmed message.

## CONVENIENCE FEATURES

### DO NOT DISTURB

Use this feature when you want to block calls to your keyset.

- While on-hook, press the **DND** key or dial **401**. The **DND** key lights steady red to remind you of this mode.
- To cancel DND, press the **DND** key again or dial **400**. The **DND** light turns off. You can make calls while in the DND mode.

### NOTES:

1. If the Hot Keypad feature has been turned off, you must first lift the handset or press the **SPEAKER** key.
2. If you place your keyset in DND mode and you do not have a **DND** key, your **TSI** key will flash to indicate DND status.

### ONE TIME DND

If you are on a call and you do not wish to be interrupted while on that call, you can press the **DND** key and place your station in Do Not Disturb. When you hang up at the end of the call, DND will be automatically canceled and your keyset will be able to receive new calls. This feature requires a **DND** key.

### MUTE

You can mute the handset transmitter or the microphone during any conversation:

- Press the **MUTE** key. It will light red.
- To resume speaking, press the **MUTE** button again. The light turns off.

### BACKGROUND MUSIC

When a music source is supplied, you may listen to music through the speaker in your keyset:

- While on-hook, press the **HOLD** button to hear music.
- Press the **HOLD** button again to turn music off.

You can set the level of background music by using the **VOLUME** keys while listening to the music. This does not affect the speakerphone level.

## ESTABLISHED CALL PICKUP

To pick up an established call in progress at a single line extension connected to a computer modem on your PC.

- Press the **EP** key for that station on your keyset and the call is automatically moved to your keyset.
- The single line extension on your modem will be disconnected.

NOTE: You must have an assigned (EP key) button on your regular keyset, for the single line station.

## APPOINTMENT REMINDER/ALARM CLOCK

This feature works like an alarm clock. Use it to remind yourself of an appointment later in the day (TODAY ONLY) or as a daily reminder every day (DAILY). You can set up to three alarms. Each one can be either a TODAY ONLY or a DAILY alarm.

When the alarm rings, you will hear three short rings repeated three times. Lift the handset to answer the alarm. If you do not, the alarm will alert you two more times at five minute intervals.

To set alarms:

- Press **TRANSFER** and then dial **112**.
- Dial the alarm number **1, 2** or **3**.
- Dial the time at which you want the alarm to sound. Enter the time as HHMM (hours and minutes) using the 24 hour clock.
- Dial **0** (NOT SET), **1** (TODAY ONLY) or **2** (DAILY) to select the alarm type.
- Press **TRANSFER** to save.
- Repeat for each alarm if needed.

To cancel individual alarms:

- Press **TRANSFER** and then dial **112**.
- Dial alarm number **1, 2** or **3**.
- Press the **HOLD** key.

NOTE: Display keysets can show a reminder message. [See Alarm Reminder Messages under Display Features.](#)

## ANSWERING THE DOOR PHONE

When you are programmed to receive calls from a door phone:

- You will receive three short rings repeated.
- Lift the handset or press **ANS/RLS** key. You are connected to the door phone.
- If an electric door lock release is installed, dial **13** to unlock the door.

## CALLING THE DOOR PHONE/ ROOM MONITOR

You may call the door phone and listen to what may be happening outside or in another room.

- Dial the extension number of the door phone.
- You will be connected to the door phone and you can listen or have a conversation.
- If an electric door lock release is installed, dial **13** to unlock the door.

NOTE: If the Hot Keypad feature has been turned off, you must first lift the handset or press the **SPEAKER** key.

## EXECUTIVE/SECRETARY HOT LINE

If programmed, an executive and a secretary can have a hot line between them. When the executive station is in the DND mode, all of its calls will ring the secretary station. If the secretary does not answer, the caller will go to the secretary's voicemail box if setup.

- Either person can press the **BOSS** key to make a voice call to the other station.
- Using the hot line will override DND at the other station. This key will light red when the other station is in use.

**To transfer a call to a Boss in DND:**

- Press the **TRANSFER** key followed by the **BOSS** key.
- Wait for the **BOSS** to answer, then announce the call and hang up to complete the transfer **OR**
- Hang up to complete a blind transfer after pressing the **BOSS** key.

## EXECUTIVE DIVERT

When the executive station is in the DIVERT mode all of his/her calls will ring the secretary station.

- Press the **DIVERT** key to pass a call while ringing.



### To transfer all calls to the Secretary:

- Press the **DIVERT** key while the phone is idle. The LED will be lit and all calls will ring the secretary.

The secretary can call the BOSS in the DIVERT mode but all other users will ring the secretary (the secretary can override the boss' DIVERT).

## GROUP LISTENING

When you are engaged on a call and you are using the handset, you may want other people to hear the distant party's voice over the speaker:

- Press the **LISTEN** key to turn on the speaker. The microphone is not in use, so the distant party does not hear other parties present in your office.
- Press **LISTEN** again to turn the speaker off and resume private conversation.
- Repeat if necessary.

NOTE: Depending on speaker volume and the acoustics of your office, it may be advisable to turn the group listening feature off before hanging up. This will eliminate a momentary squeal.

## ACCOUNT CODES

When enabled, your system allows calls to be charged to different accounts. You can enter account codes either by dialing the full code, by entering an account code "bin number", or by pressing your **ACC** key if one is assigned. Bin numbers are a 3 digit short code that will automatically insert the appropriate account code. Account codes may be a maximum of 12 digits (# may be used); if the account code is to be less than 12 characters you may end the code by pressing \* or the right soft key. The type of code used is determined by your telephone system administrator. Codes can be entered before or during a call as follows:

To enter an account code before placing the call:

- Press your **ACC** key or dial **47**.
- Dial the account code or bin number.
- You will receive a confirmation tone and display.
- When prompted dial a trunk or trunk group (i.e. 9) and the telephone number to call.

To enter an account code by interrupting the conversation:

- While on an outside call press the **ACC** key or press TRANSFER followed by **47**.
- Dial the account number or bin number (if you are entering an account code you will need to press your **ACC** key or right soft key to finalize the entry)

NOTE: If you make an error simply repeat the procedure with the correct code. Only the most recent account code dialed will be recorded.

## LOCKING YOUR KEYSSET

You can lock your keyset to control misuse of your phone while you are away. You can unlock it when you return. Your default station passcode is 1234.

	0 UNLOCKED	1 LOCKED OUTGOING Hold Button LED Flashes	2 LOCKED ALL CALLS Hold Button LED Solid
Make outside calls	YES	NO (ACCESS DENIED)	NO
Receive outside calls	YES	YES	NO
Make intercom calls	YES	YES	NO
Receive intercom calls	YES	YES	NO
Make 911 calls	YES	YES*	NO

- While on-hook, press **TRANSFER** and then dial **100**.
- Dial your four digit station passcode.
- Dial **1** to locking outgoing, **2** for locked all calls, or **0** to unlock.
- Press **TRANSFER** to store your selection.

Note\*: When 911 is programmed, 911 emergency dialing is allowed for a LOCKED OUTGOING station.

## MANUAL SIGNALLING

Use this feature when you want to send a brief 500ms ring burst to another station, regardless of the status of your phone (on-hook, off-hook, handsfree, DND, or ringing).

### To send a signal to another station:

- Press the Manual Signalling (**MS**) key.
- You may press the **MS** key repeatedly to send multiple signals to the designated station.

**NOTE: Your phone must have a Manual Signalling (MS) key with a station number extender assigned to it.**

## OFF-HOOK VOICE ANNOUNCE

Keysets may receive a voice announcement while on another call. The calling station must have an **OHVA** key. When you are in DND, you cannot receive OHVA calls. The OHVA feature will work with intercom and transferred calls. When you receive an OHVA and secure OHVA is ON, you will hear the announcement in the handset receiver, if you are using the handset. If secure OHVA is OFF then you will hear the announcement on the speaker, if you are talking on the handset. If you are using the speakerphone the announcement will always be heard through the speaker.

### To make an off-hook voice announcement:

- Dial the extension number or press the **DSS** key.

- When you receive a busy signal, press the **OHVA** key.
- After the attention tone, begin speaking.
- Finish the call by replacing the handset or pressing the **ANS/RLS** key.
- Press the flashing **CALL** button on your keyset. This will place the original party on hold and allow you to talk to the announcing party.
- To return to your first party, press the key corresponding to your original call. This will disconnect the OHVA call.

NOTES:

1. When you are voice announcing to a station close to you, use the handset to avoid an echo effect.
2. You cannot off-hook voice announce to single line telephones.

If your keyset is associated with a DCS 32 Button Add-On Module (DCS 32 AOM is not supported on the OfficeServ 7100, OfficeServ 7030), you can receive Executive OHVA calls. Executive Off-Hook Voice Announce allows you to engage in conversation on your keyset and simultaneously receive and reply handsfree to an OHVA through your DCS 32 Button Add-On Module (AOM). Use caution because the conversation through the AOM may possibly be heard by the caller on the keyset. When you receive an executive OHVA through your AOM:

- Reply by speaking in the direction of the microphone in the AOM unit.
- Adjust the volume with the **VOLUME** keys on the AOM unit.
- Press the **SPK** key on the AOM to disconnect the announcing party.

NOTES:

1. Executive off-hook voice announce can only be accomplished when an AOM is attached to your phone.
2. If the **MUTE** key on the AOM is lit, you must press the AOM's **SPK** key to answer the OHVA call.

## OHVA BLOCK

Your keyset can be programmed with an OHVA Block (**BLOCK**) key. Pressing this key will prevent anyone from making an OHVA to you until you press the button again and cancel the blocking.

## OHVA REJECT

Your keyset can be programmed with an OHVA Reject (**REJECT**) key. Pressing this key while receiving an OHVA call will disconnect the voice announcing party and return you to your original call.

## IN GROUP/OUT OF GROUP

If your keyset is assigned to a station ring group, you can remove your keyset from the group and then put it back in. While you are out of the group, you can receive calls to your extension number but not calls to the group number. If you have an **IN/OUT** key with the group number assigned.

- Press the **IN/OUT** key. It will light red when your keyset is in the group.
- Press the **IN/OUT** key again to exit the group and turn the light off. Repeat as necessary.

If you do not have an **IN/OUT** key:

- Dial the **IN/OUT** access code number \_\_\_\_\_, then the group number, then **0** to exit the group or **1** to enter the group.

NOTE: If the Hot Keypad feature has been turned off, you must first lift the handset or press **SPEAKER** key.

The **IN/OUT** key can include an extender to indicate the specific group that this key will affect. This means that if you are in multiple groups, you can decide for which groups you will receive calls.

# CUSTOMIZING YOUR KEYSET

## AME PASSWORD

This feature allows customers using the AME feature to enable password protection. This will prevent unauthorized users from listening to your messages being left. The passcode is the same as your station passcode. This feature only applies if there is a Samsung voicemail installed in the system and your keyset has a programmed AME key.

- With the handset on-hook, press **TRANSFER** and then dial **110**.
- Dial **101** to turn on AME PASSCODE or **100** to turn it off.
- Press **TRANSFER** to store your selection.

## AUTO CAMP-ON

This option allows intercom calls to be automatically camped on, if possible, when a busy station is called.

- With the handset on-hook, press **TRANSFER** and then dial **110**.
- Press **081** to turn CAMP-ON on or **080** to turn it off.
- Press **TRANSFER** to store your selection.

## SELECT RING TONE

Each keyset user can select any one of eight ring frequencies:

- While on-hook, press **TRANSFER** and then dial **111**.
- Dial **1-8** or press the **UP** and **DOWN** keys to hear each tone.
- When you hear the tone that you prefer, press **TRANSFER** to save it.

**NOTE: Specific lines or stations may be programmed to ring with a different tone than what you have selected for your keyset.**

## CHANGE YOUR PASSCODE

From the factory, your station passcode is 1234. You can change your station passcode whenever you desire.

- While on-hook, press **TRANSFER** and then dial **101**.
- Dial your old passcode.
- Dial a new passcode (must be four characters). You can use **0-9**.
- Redial the new passcode to verify. If successful, you will hear two beeps. Four beeps indicate an incorrect code. Reenter the code again.
- Press **TRANSFER** to store the new passcode.

## SET ANSWER MODE (INTERCOM)

You can receive internal calls in one of three modes ([see Answering Intercom Calls under Intercom Calls for descriptions](#)):

- While on-hook, press **TRANSFER** and then dial **103**.
- Dial **0** for Ringing, **1** for Auto Answer or **2** for Voice Announce.
- Press **TRANSFER** to store your selection.

**NOTE:** When your keyset is programmed for Auto Answer and you have Forward No Answer (FNA) turned on, you must answer screened transfers by pressing the **ANS/RLS** key before your FNA timer expires or the call will forward.

## SET ANSWER MODE (CO)

Your incoming CO calls can be set to follow the intercom answer mode.

- While on-hook, press **TRANSFER** and then dial **110**.
- Dial **15** to access **AUTO ANS CO**.
- Press the **VOLUME UP** or **DOWN** key to change status.
- Press **TRANSFER** to store your selection.

**NOTE:** When your keyset is programmed for Auto Answer and you have Forward No Answer (FNA) turned on, you must answer screened transfers by pressing the **ANS/RLS** key before your FNA timer expires or the call will forward.

## AUTOMATIC HOLD

While on an outside call, pressing a line key, route key or a flashing **CALL** button will automatically put your call on hold and connect you to the next call. This feature can be turned on or off at your keyset.

- With the handset on-hook, press **TRANSFER** and then dial **110**.
- Dial **001** to turn Automatic Hold on or **000** to turn it off.
- Press **TRANSFER** to store your selection.

**NOTE:** Intercom calls can be automatically put on hold by pressing **TRANSFER**.

## HEADSET OPERATION

Keyset users can switch between headset mode and handset mode. When using headset mode, press the **ANS/RLS** key to answer and release calls.

- With the handset on-hook, press **TRANSFER** and then dial **110**.
- Dial **021** to use the headset or **020** to use the handset.
- Press **TRANSFER** to store your selection.

Your keyset may be equipped with a Headset mode key. If it is so equipped pressing this key while the light is out will cause the keyset to enter headset mode and the light will illuminate to indicate this. Pressing the key while the light is lit will cause the keyset to return to handset mode and the light will go out.

## HOT KEYPAD

On your phone system your keyset's keypad can be made "live" or "hot" so that it is not necessary to lift the handset or press the **SPEAKER** key before you begin dialing. Calls can be made and features activated by simply dialing the C.O. line number, trunk group access code, intercom number or feature access code. To activate this feature:

- With the handset on-hook, press **TRANSFER** and then dial **110**.
- Dial **031** to turn the Hot Keypad on or **030** to turn it off.
- Press **TRANSFER** to store your selection.

## KEY CONFIRMATION TONE

You can hear a short beep (confirmation tone) each time you press a button on the dial pad. This tone can be turned on or off.

- While on-hook, press **TRANSFER** and then dial **110**.
- Dial **040** to turn tones off or **041** to turn tones on.
- Press **TRANSFER** to store your selection.

## REJOINING A PAGE

This feature allows you to hear the remaining portion of an ongoing internal page after you return your keyset to idle. To enable this feature:

- With the handset on-hook, press **TRANSFER** and then dial **110**.
- Dial **051** to turn this feature on or **050** to turn it off.
- Press **TRANSFER** to store your selection.

## RING PREFERENCE

This feature automatically answers ringing calls when you lift the handset or press the **ANS/RLS** key. This method will always answer calls in the order they arrived at your keyset. When you turn ring preference off, you must press the flashing button to answer a call, allowing you to answer calls in the order you choose.

- With the handset on-hook, press **TRANSFER** and then dial **110**.
- Dial **061** to turn ring preference on or **060** to turn it off.
- Press **TRANSFER** to store your selection.

## AUTO ANSWER CO CALLS

This option will allow CO calls that directly ring your phone to auto answer. When a CO call arrives at your station and this option set for ON your phone will sound two beeps, the same as when a screened transfer is completed, and you will be connected to the CO call. In order for this option to work the station must also be programmed for auto answer ([see SET ANSWER MODE](#)).

- While on hook, press **TRANSFER** and then dial **110**.
- Dial **151** to turn Auto Answer CO on or **150** to turn it off.
- Press **TRANSFER** to store your selection.

NOTE: Outside lines must ring your station directly for the Auto Answer CO to work. Lines ringing a station group will not cause your phone to Auto Answer the call.

## DISPLAY SPEED DIAL NAME

This option allows you to view the name associated with a speed dial number as it is dialed.

- With you handset on-hook, press **TRANSFER** and then dial **110**.
- Press **111** to turn **DISP SPDNAME** on or **110** to turn it off.
- Press **TRANSFER** to store your selection.

## CALLER ID REVIEW ALL

This feature allows display keyset users to review Caller ID information for calls sent to their stations. This list can be from ten to fifty calls in a first in, first out basis. The list includes calls that you answered and calls that rang your station but that you did not answer. When reviewing this list, you can press one button to dial the person back. The system must be using LCR to dial the stored number.

- With you handset on-hook, press **TRANSFER** and then dial **110**.
- Press **121** to turn **CID REVIEW ALL** on or **120** to turn it off.
- Press **TRANSFER** to store your selection.

## SECURE OHVA

This option allows you to receive OHVA calls via the speaker while you are on the handset.

- With you handset on-hook, press **TRANSFER** and then dial **110**.
- Press **131** to turn **AUTO CAMP-ON** on or **130** to turn it off.
- Press **TRANSFER** to store your selection.

## CONFIGURE MOBILE EXTENSIONS (MOBEX)

This feature allows you to configure options for any Mobile Extension (MOBEX) ports that are assigned to you by your telephone system administrator. You can turn a port on or off; set the telephone number for the port; or set the caller ID you will be calling in from. The caller ID field has no effect unless you have been authorized as an Executive MOBEX user. Check with your telephone system administrator for further details on your specific system configuration.

### To set the phone number a MOBEX port can reach you on:

- Press **TRANSFER** and then dial **126**.
- Dial your station pass code.
- Dial the number of the port you wish to configure (1-5) (you may also use the Volume Up and Volume Down keys to select a port and press the right soft key to confirm).
- Dial **0** to select the telephone option.
- Dial the number of a C.O. line to use when making calls to this MOBEX port.
- Dial the phone number you can be reached at by users calling this MOBEX port.
- Press **TRANSFER** to store your selection and exit programming.

### To set the caller ID of the location you will be calling in from:

- Press **TRANSFER** and then dial **126**.
- Dial your station pass code.
- Dial the number of the port you wish to configure (1-5) (you may also use the Volume Up and Volume Down keys to select a port and press the right soft key to confirm).
- Dial **1** to select the caller ID option.
- Dial the phone number you will be calling in from.
- Press **TRANSFER** to store your selection and exit programming.

### To turn a MOBEX port ON or OFF:

- Press **TRANSFER** and then dial **126**.
- Dial your station pass code.
- Dial the number of the port you wish to configure (1-5) (you may also use the Volume Up and Volume Down keys to select a port and press the right soft key to confirm).
- Dial **2** to select the activation status option.
- Dial **0** to turn the port on, dial **1** to turn the port off.
- Press **TRANSFER** to store your selection and exit programming.

## DISPLAY FEATURES

### INTERACTIVE DISPLAY KEYS

The three keys below the display are substitutes for dedicated feature keys and access codes. Pressing one of these keys has the same effect as pressing a programmable key. These keys are called soft keys as their functions are not fixed. They change to present you with the best options for that call condition. The use of soft keys allows the programmable keys to be used for more **DSS** and speed dial keys.

The **SCROLL** key is used to display options available to the user at a particular time or during a specific procedure. Press this key once while in the idle state to view the three main categories available.

201:STN NAME  
CALL OTHER ANS

**ANSWER:** Guides you through the options to answer calls.

**OTHER:** Guides you through features other than making or answering calls.

**CALL:** Guides you through the options to make a call.

Select one of the main categories: **CALL**, **OTHER** or **ANS (ANSWER)**. Press the **SCROLL** key to display additional options available under each of the three main categories. The symbol **➡** displayed as the last character on the lower line of the display indicates that there are additional options. Press the **SCROLL** key to display these additional options.

User instructions will be displayed in lower case letters. Options assigned to soft keys will be in upper case letters.

### DIRECTORY INFORMATION

An 11 character directory name can be assigned to each extension number. Display keypad users can view the name of the called or calling station before answering.

Each outside line can have an 11 character directory name. Incoming calls can be easily identified and answered with different greetings.

Outside and internal calls ringing to a station group will display [CALL FOR xxx] where xxx is the station group number. This allows you to answer calls directed to you differently than calls directed to your group.

## CALL LOG

This system can log both incoming and outgoing calls placed from or to your telephone. You must have a **LOG** button programmed on your keyset and assigned a review list.

Each **IN** and **OUT** list can be up to 50 numbers maximum. They are assigned in blocks of 10 each.

To view your incoming and outbound call logs:

- Press the **LOG** key.
- Press either the **IN** or **OUT** key.
- View the first **IN/OUT** telephone number. At this point you may select one of the three options related to this number or use the **UP/DOWN** keys to scroll through your list of calls.
- Press the **CLEAR** key to erase this number from the list.
- Press the **NND** key repeatedly to view the Name, Number, or Date associated with this call.
- Press the **DIAL** key to call this number.

This options are the same for the incoming or outgoing call logs.

## DIAL BY NAME

Each station or speed dial number can have an associated directory name. A station or speed dial number can be selected by scrolling alphabetically through a directory name list. This on-line “phone book” allows the user to look up and dial any station or speed dial number in seconds.

- Press the **DIR** key (**DIRECTORY**).
- Select the directory you wish to use: **PERS** (personal speed dial numbers), **SYS** (system speed dial numbers) or **STN** (station names).
- Dial the key on the keypad that corresponds to the first letter of the name you wish to search for.
- Use the **UP** and **DOWN** arrows to scroll through the names.
- Press the **DIAL** soft key to dial the number.

NOTE: A **DIR** key can have an extender to take you directly to one of the above lists (**PERS**, **SYS**, or **STN**).

## CALL PROGRESS DISPLAYS

During everyday call handling, your keyset display will provide information that is helpful and in some cases invaluable. Displays like [CALL FROM 203], [TRANSFER TO 202], [701: RINGING], [TRANSFER FM 203], [708 busy], [Camp on to 204], [Recall from 204], [Call for 501], [message frm 204] and [FWD ALL to 204] keep you informed of what is happening and where you are. In some conditions you are prompted to take an action and in other cases you receive directory information.

## DISPLAY NUMBER DIALED

Display keysets begin showing digits as they are dialed. They will stay in the display until the call duration timer comes on automatically or the **TIMER** button is pressed. If the call duration timer is not used, the number dialed will be displayed until the call is released, transferred or put on hold.

## CALL DURATION TIMER

The system can be set to automatically time outside calls. A few seconds after you dial a telephone number, the timer appears in the display. It appears immediately for incoming calls. The call timer continues for the duration of the call. Call duration times are displayed in minutes and seconds. If a call lasts longer than 60 minutes, the timer restarts.

You can press the **TIMER** key to manually begin timing a call. Press it again to stop timing. If you press it while the automatic timer is on, the call duration time is restarted.

## AUTO TIMER

Display keyset users may have the timer automatically start when they answer incoming calls or after a short delay on an outgoing call.

- With the handset on-hook, press **TRANSFER** and then dial **119**.
- Dial **41** to turn the auto timer on or **40** to turn it off.
- Press **TRANSFER** to store your selection.

## TIMER FUNCTION

Display keyset users may use this feature as a simple stopwatch.

- When the keyset is idle, press the **TIMER** button to start timing.
- Press the **TIMER** button again to stop timing.
- Read the elapsed time in the display.
- Lift the handset and replace it. The display will return to date and time.

## VIEWING MESSAGE INDICATIONS

You can view all of your message indications before you return them:

- With the handset on-hook, press the **MESSAGE** key with the red flashing light.
- The first station that left a message indication will be displayed.
- Press the **UP** and **DOWN** arrows to scroll through the stations that left message indications. Use the soft keys to reply, clear or advance to the next message.
- Press the **ANS/RLS** key to return your keyset to the idle condition.

## ALARM REMINDER MESSAGES

When you use the alarm/appointment reminder feature, you create a 16 character reminder message. When the alarm rings, your message will appear instead of [ALARM REMINDER]. To program reminder messages:

- Press **TRANSFER** and then dial **116**.
- Dial the alarm number **1, 2** or **3**.
- Dial the time you want the alarm to go off. Enter the time as HHMM (hours and minutes) using the 24 hour clock.
- Dial **0** (NOT SET), **1** (TODAY) or **2** (DAILY) to select the alarm type.
- Write your message using the dial pad keys. Each press of a key selects a character. Pressing the next key moves the cursor to the next position. For example, if your message is "TAKE MEDICATION," press **8** once to get the letter "T." Press **2** once to get "A." Press **5** twice to get "K." Continue selecting characters from the following table to complete your message.
- Press the **TRANSFER** key to store the alarm and reminder message.
- Repeat for each alarm if needed.

COUNT	1	2	3	4	5
DIAL 0	<	>	.	)	0
DIAL 1	space	?	,	!	1
DIAL 2	A	B	C	@	2
DIAL 3	D	E	F	#	3
DIAL 4	G	H	I	\$	4
DIAL 5	J	K	L	%	5
DIAL 6	M	N	O	^	6
DIAL 7	P	Q	R	S	7

DIAL 8	T	U	V	Q	8
DIAL 9	W	X	Y	Z	9
DIAL *	:	=	[	]	*

NOTES:

1. When the character you want appears on the same dial pad key as the previous character, press **UP** to move the cursor one space to the right.
2. Other symbols are available for DIAL #.

To cancel an individual alarm and reminder message:

- Press **TRANSFER** and then dial **112**.
- Dial alarm number **1, 2** or **3**.
- Press the **HOLD** key.
- Press the **TRANSFER** key.

## PERSONAL SPEED DIAL NAMES

Each personal speed dial number can have an 11 character name assigned to it. This name is used to select the speed dial bin when you are dialing by directory.

- Press **TRANSFER** and then dial **106**.
- Dial the speed dial bin number **00–49**.
- Write your message using the procedure described in [Alarm Reminder Messages](#).
- Press the **TRANSFER** key to store the speed dial name.
- Repeat for each speed dial bin if necessary.

## STATION NAMES

You can assign an 11 character name to your keyset. This allows other display keyset users to call you using the directory dial feature.

To program a station name:

- Press **TRANSFER** and then dial **104**.
- Enter the 11 character name using the procedure described in [Alarm Reminder Messages](#).
- Press **TRANSFER** to store the name.

## MANAGING KEY ASSIGNMENTS

You can view your key assignments and add extenders to some of your programmable keys for easy one touch operation of frequently used features.

- While on-hook, press **TRANSFER** and then dial **107**.
- Use the **VOLUME** keys to scroll through all of your programmable keys **OR** Press the programmable key to which you want to add the extender.
- When you reach a key listed below, dial the corresponding extender.
- Press **TRANSFER** to store and exit programming.

Please refer to the [Enhanced Display Programming Section](#) provided by your installation company when requested for a complete list of descriptions and extenders for any keys you may have programmed on your keyset.

NOTE: Confirm that the cursor is placed correctly before you enter the extender.

## LCR WITH CLEAR

When you are making an outside call using LCR and dial an incorrect digit, you can press the **CLEAR** soft key to reenter the telephone number. You do not need to redial **9** to reaccess LCR.

## BACKSPACE WITH LCR

If you misdial while using LCR, you can delete digits shown in the display by pressing the **BSPC** soft key as many times as necessary.

## TEXT MESSAGING

This feature allows two digital keyset users to respond to each other with preprogrammed text messages. After receiving an Off Hook Voice Announcement or Station Camp-On, you may respond with a text message while continuing to talk and listen to your outside party. The other station can view this message and take the appropriate action or respond back with another text message.

You **must** be permitted to use the Text Messaging feature. See your System Administrator or Technician to be assigned this feature. They will assign you ten (10) blank messages. You can create any 16 character messages (01 to 10) that are appropriate for your use.

NOTE: See [ALARM REMINDER MESSAGES](#) for instructions on how to enter characters to create a text message.

Familiarization with the two digit message numbers you will use the most will make this procedure quick and easy. However if you do not know them, use the **UP/DOWN** key to scroll to the desired message, then press **SEND**.

The basics steps in text messaging are:

1. Press **TMSG** soft key to begin text messaging.
2. Dial the 2 digit number for the desired message.
3. Confirm this is the intended message then press **SEND**.
4. Wait for a reply from the other station (steps 1, 2 & 3)
5. When any station presses **EXIT** the displays at both stations return to their previous call progress condition.

At all times after step 1 you can talk and listen to your caller while repeating steps 2.

The example on the following page will better demonstrate how to use Text Messaging. In this example station 201 is making an off hook voice announcement to station 205 who after hearing the announcement will respond with a text message.



**STATION 201: LINDA**

received a call on line 702

Talking on line 702

702:	01:15
CONF	PAGE MUTE

Press **TRANSFER**

Transfer:
RETURN

Dial **205**

205:busy	
OHVA	CAMP ON



OHVA to 205

Wait for reply

ASK THEM TO HOLD	
TMSG	EXIT



702:	01:45
CONF	PAGE MUTE

**STATION 205: JOHN**

is talking on line 701

701:	05:25
------	-------

OHVA from 201	
TMSG	REJECT

GIVE THE CALL	
TMSG:01	SEND

Dial **03** or press ↑ twice

ASK THEM TO HOLD	
TMSG:03	SEND



Wait for reply

701:	05:55
CONF	PAGE MUTE

# CALLER ID

## WHAT IS CALLER ID?

Caller ID is the name given to the telephone company-provided feature that delivers the telephone number and sometimes the name of the person calling your phone. There are two types of Caller ID; the first delivers the calling party's telephone number only and the second (sometimes referred to as "Deluxe" Caller ID) delivers both the calling party's telephone number and name as listed in the telephone directory.

The phone system can handle both types of Caller ID; in fact, in the case of number only delivery, the system can be programmed to insert a name for a specific telephone number. However, even though you are paying to receive Caller ID information, there are some circumstances that mean you will not receive this information. The six most common reasons are listed below along with the display information that the system will provide.

- |                  |  |
|------------------|--|
| PRIVATE          | The caller does not wish his/her name or number to be revealed to you. This type of call can be stopped at the telephone company by dialing an access code on your outside lines. This will redirect these PRIVATE calls to an announcement that states that you do not wish to receive calls that have had Caller ID blocked. The code to block these calls can usually be found in the front section of the telephone directory. |
| OUT OF AREA      | The caller is calling from an area that cannot provide Caller ID information (for example, international calls) or he/she is calling from a type of circuit that cannot provide Caller ID information, for example, some outbound WATS lines.  |
| PAYPHONE         | The caller is calling from a coin-operated telephone. The telephone company will send this information as there are no directory listings for pay phones. The number will be delivered as usual.   |
| INVALID CID INFO | This is a message that will be displayed when CID information is sent on the line but was somehow corrupted.   |
| NO CID RECEIVED  | This is a message that will be displayed when there was no CID information sent on the line.   |

NO CID DSP      Caller ID Digital Signal Processors (CIDDSP's) are resources in the OfficeServ 100, the OfficeServ 500, and OfficeServ 7000 Series systems required for receiving CID data. If there are no CIDDSP's available at the time a call comes in, this is the message you will see on your display.

NOTE: The Caller ID features may require optional software and/or hardware. Please see your service and installation company for details.

## WHAT IS ANI?

### [T1/E&M NOT SUPPORTED ON THE OS 7030, OS 7100 and OS 7200-S]

ANI (Automatic Number Identification) is a feature offered by some telephone service providers that provides the calling party's telephone number. This service is only available on E&M Tie Lines on a T1, digital trunk. ANI is similar to Caller Identification (CID) but the format and information of the calling person is different. CID uses FSK signalling and ANI uses DTMF signalling. Usually, with ANI, a calling party's identity is the Listed Directory Number (LDN) unless a separate bill-to-number has been specified, (in which case the bill-to-number will be sent). Note that ANI does not provide calling party NAME, only the number. The phone system can provide calling number to name translation table.

## WHAT IS CLI?

On ISDN circuits, calling party information is called CLI and is supported on both BRI (not supported in the US) and PRI type circuits on the OS 100 and on the OS 500 systems (not supported on OS 7030). On BRI circuits the OS 100 and the OS 500 only support number delivery and, like ANI, a name can be attached to the telephone number of frequent callers via the Caller ID translation table. On 5ESS and NI2 PRI circuits both name and number support is provided on the OfficeServ 100, OfficeServ 500, and OfficeServ 7000 Series systems.

## SELECTING YOUR CALLER ID DISPLAY

Simultaneous display of Caller ID name and number on incoming CO calls on both lines of display keysets is supported on all OfficeServ systems, on transferred CO calls, you can decide if you want to see the Caller ID name or Caller ID number in the first line of the display. Regardless of which data is selected, you can press the **NND** key to view the other pieces of Caller ID information. To select the type of Caller ID information you wish to view:

- With the handset on-hook, press **TRSF** and then dial **119**.
  - To set the first line of a ringing call display dial **0**.
  - To set the second line of a ringing call display dial **1**.
- Set the data to display from the following:

- To show nothing dial **0**.
- To show Caller ID Number dial **1**.
- To show Caller ID Name dial **2**.
- To show the DID Number the call came in on dial **3**.
- To show the Name of the DID the call came in on dial **4**.
- To show the Name of the Group the call came in for dial **5**.
- To show the DID Number and then Name of the DID dial **6**.
- To show the Name of the DID and then the DID Number dial **7**.
- To set the top line of the display shown after answering a call dial **2**.  
Set the data to display from the following:
  - To show Caller ID Number dial **0**.
  - To show Caller ID Name dial **1**.
  - To show the DID Number the call came in on dial **2**.
  - To show the Name of the DID the call came in on dial **3**.
  - To show Caller ID Number and then the DID Number dial **4**.
  - To show Caller ID Name and then the DID Number dial **5**.
  - To show the DID Number and then the name of the DID dial **6**.
  - To show the Name of the DID and then the DID Number dial **7**.
  - To show the C.O. line information dial **8**.
- To set the format if the C.O. line information when the above is set to show C.O. line information dial **3**.
  - To show the C.O. line number and the dialed or Caller ID Number dial **0**.
  - To show only the dialed or Caller ID Number dial **1**.
- Press **TRANSFER** to exit and store your selection.

## VIEWING THE NEXT CALLER ID CALL

In the event that you have a call waiting or a camped-on call at your keyset, you can press the **NEXT** key to display the Caller ID information associated with the call in queue at your keyset. Either the CID name or CID number will show in the display depending on your Name/Number selection.

To view Caller ID information for calls that have been camped-on to your keyset, press the **NEXT** key. If your keyset does not have a **NEXT** key, press the **CID** key and then the **NEXT** soft key.

## SAVING THE CALLER ID NUMBER

At any time during an incoming call that provides CID information, you may press the **SAVE** key to save the CID number. If your keyset does not have a **SAVE** key, press the **CID** key, the **SCROLL** key and then the **SAVE** soft key. The system must be using LCR to dial the saved number.

## REDIALING A SAVED CALLER ID NUMBER

To redial a number that has been saved, press the **SNR** key or dial **17**.

NOTES:

1. Your telephone system must have LCR correctly programmed to redial the saved number.
2. If the Hot Keypad feature has been turned off, you must first lift the handset or press the **SPEAKER** key before you begin dialing.

## STORING A CALLER ID NUMBER

At any time during an incoming call that provides CID information, you may save the CID number as a speed dial number in your personal speed dial list. To store a Caller ID number in a personal speed dial bin:

- Press the **STORE** key. The system displays the speed dial bin in which the number was stored, **OR**
- Press the **CID** key and then press the **SCROLL** key.
- Press the **STORE** soft key.
- The system displays the speed dial bin in which the number was stored.

NOTE: Your telephone system must have LCR correctly programmed to redial the saved number. If LCR is not being used on your system, you will not be allowed to STORE CID numbers.

## INQUIRE CALLER ID PARK/HOLD INFO

If you are informed that an incoming call is on hold or has been parked for you, you may view the Caller ID information before you retrieve the call. This may influence how you choose to handle the call.

From an idle keyset:

- Press the **INQUIRE** key, **OR**  
Press the **CID** key and then the **INQUIRE** soft key.
- Dial the trunk number.
- You may now answer the call by pressing the **ANS** key, **OR**  
You may use **NND** to view more information about this call, **OR**  
You can return to the idle condition by pressing **IGNORE**.

If you are on a call:

- Press the **INQUIRE** key. Your existing call will go on hold, **OR**  
Press the **CID** key and then the **INQUIRE** soft key to place the first call on hold.
- Dial the trunk number.

- You may now answer the call by pressing the **ANS** key, **OR**  
You may use **NND** to view more information about this call, **OR**  
You can return to the idle condition by pressing **IGNORE**.

NOTES:

1. If you are on an intercom call or you have Automatic Hold turned off, you must finish the existing call or place it on hold before inquiring.
2. If you inquire about an outgoing call, you will receive a [call no longer available] display.

## REVIEWING PAST CALLER ID CALLS

This feature allows you to review CID information for calls sent to your keyset. This list can contain 10–50 calls in a last-in, first-out basis. The list includes calls that you answered and calls that rang your keyset but that you did not answer (missed calls). When reviewing this list, you can press one button to dial the person back. The system must be using LCR to dial the stored number. To access the CID information stored in your REVIEW list:

- Press the **REVIEW** key, **OR**  
Press the **CID** key and then press the **REVIEW** soft key.
- If you have entries in your review list, the most recent call will be shown first.
- You can now **CLEAR** this entry, **OR**  
Use **NND** to view more information about this call, **OR**  
Press **DIAL** to call this person back, **OR**  
Press **SCROLL** and then press **STORE** to save this number in a personal speed dial bin.

NOTES:

1. Each keyset defaults with ten review bins. Please see your system administrator to determine the number of bins assigned to your keyset.
2. Your system must have LCR correctly programmed to allow you to **DIAL** numbers from the review list or to **STORE** entries from the review list.

## iDCS 64 BUTTON MODULE

### WITH KEYSET

The 64 button module is used when you need more programmable keys added to your keyset. The 64 red LED's provide visual indication of calls and features. The extra programmable keys are used exactly like the ones on your keyset. Make them DSS/BLF keys or feature keys. As a DSS/BLF the size of the 64 button module allows for greater call status and faster call processing. The 64 button module does not support executive off-hook voice announce (OHVA) and does not have a microphone. A maximum of two 64 button modules can be assigned to any keyset.

## Samsung Voicemail

This section describes how to setup and use the various features available to a Subscriber. A Subscriber is a person that has been authorized access to the various features and services available in the Samsung Voicemail. Please review this section carefully before you use your Authorized Features and Services, known as Subscriber Services.

Voicemail is one of the Subscriber Services available. Your voicemail box has the capability of storing private messages, and offers a number of options for sending or redirecting messages as well as provides several ways to notify you of new messages.

Another very common Subscriber Service is Access Manager. This allows you control over when and where you receive your calls as well as what to speak to your callers in the event you are unable to speak to them directly. The 'events' are referred to as "Call Conditions": No-Answer, Busy, and Blocked are the most commonly used Call Conditions.

This guide can be used by Subscribers from within the office or from telephones outside the office. The basic operation is the same, but the access method will be different. [See the Subscriber Services Menu Diagram for more details.](#)

Note that some features and prompts detailed here may not be available to all Subscribers. See your System Administrator if you have questions about feature availability.

# Subscriber Services Menu

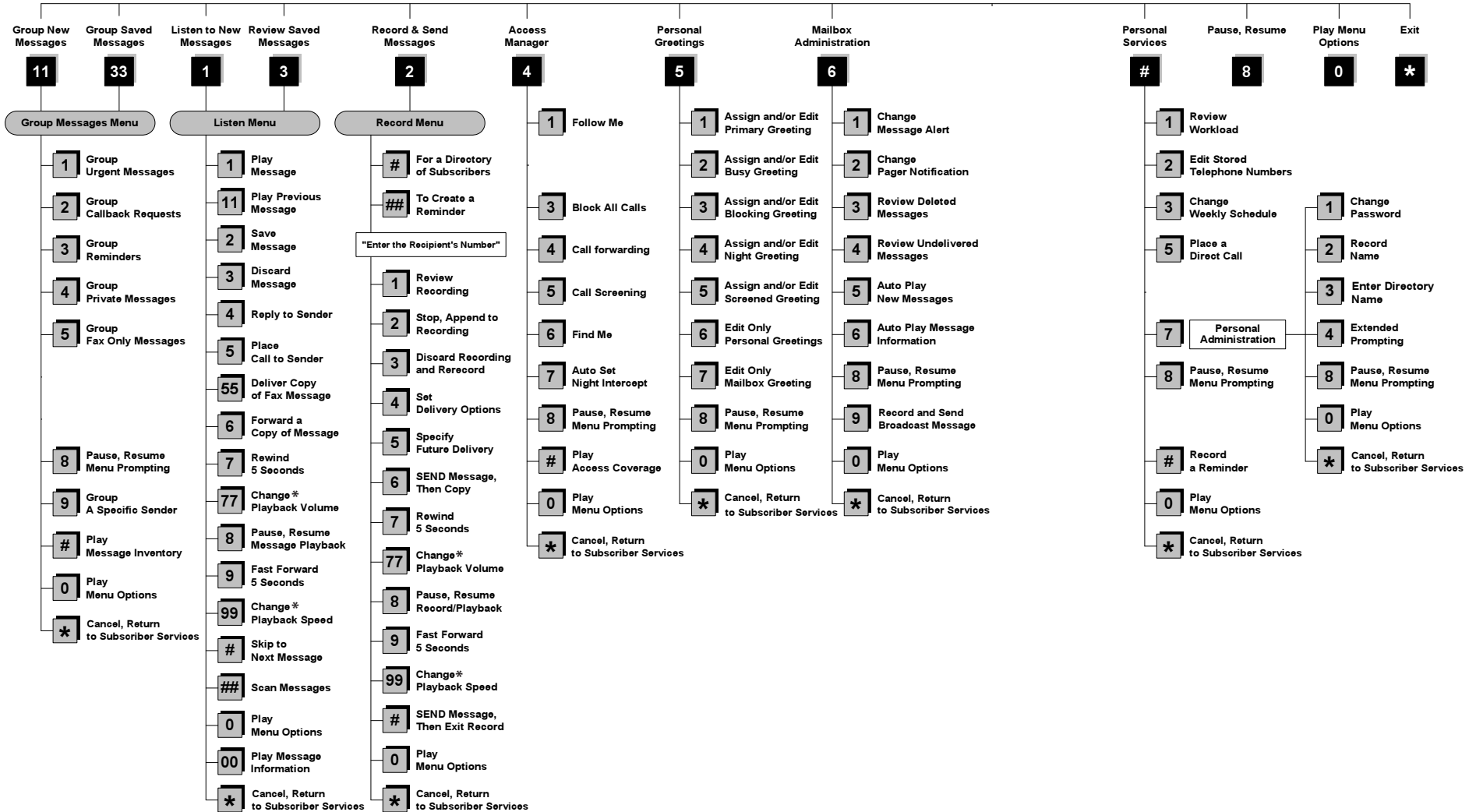

NOTE: All options shown MAY NOT be authorized. If an option is not available please speak to your system administrator.

\*Change Playback Volume and Speed not available on the OfficeServ 7130, OfficeServ 7100, OfficeServ 7200-S or the OfficeServ IP-UMS.

## ACCESSING YOUR MAILBOX

*[Also known as Subscriber Services Menu]*

### Inside Callers *[Subscriber logging in from their Desk]*

- Dial the voicemail access number or press the key assigned to ring the voicemail [VMMSG].
- Enter your personal password when prompted (the default password is 0000).

### Outside Callers *[Subscribers calling from Cell Phones or outside of the office environment]*

- Dial the phone number that will be answered by the voicemail. The main greeting will answer.
- At the main greeting dial [#] plus your Subscriber (or mailbox) number (Subscriber and Mailbox numbers will usually match your extension number).
- Enter your personal password when prompted (the default password is 0000).

### Access your Subscriber Services (or Mailbox) from a Station other than your Own (or checking a mailbox associated with a different station)

- Press the [VMMSG] key or dial the voicemail **group number**. You will be prompted to enter a password.
- Press [\*]. This will take you to the Main Auto Attendant Menu.
- Press [#] plus the Subscriber number of your choice. You will be prompted to enter your password.

At this point the inside and outside callers follow the same instructions. You will hear a message stating the number of messages left in your mailbox. You will then hear the Subscriber Services Menu with the following options:

- 1 Listen to New Messages - [See Listening to your Message.](#)
- 2 Record and Send Message - [See Sending Messages.](#)
- 3 Review Saved Messages - [See Listening to your Message.](#)
- 4 Access Manager - [See Access Manager.](#)
- 5 Personal Greetings - [See Personal Greetings.](#)
- 6 Mailbox Administration - [See Mailbox Administration.](#)
- # Personal Services - [See Personal Services.](#)
- \* Return to Main Menu.

## GETTING STARTED

Using your new Samsung Voicemail Subscriber Services is as simple as following a few simple spoken instructions. First time users should read this section as a tutorial. You should start with the following steps:

- Access your Subscriber Services Menu - You already know how to do this.

### From the Subscriber Services Menu:

- Record a Primary/No-Answer Personal Greeting. Dial [5][1].
- Record a Mailbox Greeting. Dial [5][7].
- Change your access code (Password). Dial [#][7][1].
- Record your name. Dial [#][7][2].
- Enter your directory name. Dial [#][7][3].

After you have completed the steps above your Subscriber Services are set up and ready to use.

## LISTEN TO YOUR MESSAGES

If there are new messages in your mailbox your [VMMSG] key will be lit. Call the Samsung Voicemail by pressing this key, and when prompted enter your password. You will then be at the Subscriber Services Menu. Select [1] to listen to new messages or [3] to listen to saved messages.

Note: After you enter your password, if "Autoplay of New Messages" is enabled and you have new messages the Samsung Voicemail will begin to play them automatically. A subscriber can control this feature. From the Subscriber Services Menu [6] [5] toggles "Autoplay of New Messages" ON/OFF.

## SUBSCRIBER SERVICES MENU

The following is a list of all the options available in the Subscriber Main Menu.

- 1 LISTENING TO NEW MESSAGES
- 11 GROUP NEW MESSAGES
- 2 RECORD AND SEND A MESSAGE
- 3 LISTENING TO OLD MESSAGES
- 33 GROUP OLD MESSAGES
- 4 ACCESS MANAGER
- 5 PERSONAL GREETINGS
- 6 MAILBOX ADMINISTRATION
- 8 PAUSE / RESUME

- 0 PLAY MENU OPTIONS
- \* EXIT TO AUTO ATTENDANT
- # PERSONAL SERVICES

## 1 or 3

### LISTENING TO OLD OR NEW MESSAGES

- 1 Play / replay the message you just heard.
- 11 Play the previous message.
- 2 Save the message you just heard and listen to the next message.
- 3 Delete the message you just heard and listen to the next message.
- 4 Reply to the message.  
This will allow you to leave a message in the mailbox of the sender (if the sender has a mailbox on this system).
- 5 Return the call directly to the telephone number that left the message.  
This will work for internal and external callers, but Caller ID service is needed to use this feature on an outside call.
- 55 Deliver a fax copy.  
This will allow you to receive attached faxmail document(s). Faxmail documents can be delivered to any fax machine of your choice as long as out calling is authorized. You can also have faxmail messages automatically delivered to the fax machine of your choice.
- 6 Forward the message and saves a copy.  
The subscriber can be selected by dialing their mailbox number (nnn), using the directory service (#) or you may also add comments and leave it as a memo to yourself (##).  
The Send and Copy Service (option 6) allows a user to send copies of a message to multiple recipients easily. A different introduction message may be left for each recipient.
- 7 Rewind the message 5 seconds.
- 77 Change playback volume of the recording. **[Not available on OS 7030, OS 7100, OS 7200-S or OS IP-UMS]**  
There are two levels of volume during playback. Dialing this code will toggle between the two levels.
- 8 Pause or resume during message playback.
- 9 Fast forward the message 5 seconds.

- 99 Change playback speed of the recording. **[Not available on OS 7030, OS 7100, OS 7200-S or OS IP-UMS]**  
There are two levels of speed during playback. Dialing this code will toggle between the two speeds.
- 0 Play options.  
Pressing this key will play all the menu options available to you from this point.
- 00 Hear the time and date, and sender's information of the message you just heard. Sender information is not available on outside calls.
- # Move to the next message. This does not Save or Discard the current message - it is retained as new.
- ## Scan. Plays first 7 seconds of a message then skips to next message. This is similar to the scan button on a radio. It will allow you to find a specific message quickly. To stop scanning press [1].
- \* Cancel and return to previous menu.

## 11 or 33

### GROUP NEW OR OLD MESSAGES

Messages can be grouped as either Reminders, press [3] or Messages from a specific sender, press [9].

Additionally you can press [#] and hear a summary of your mailbox contents:

- a) Number of messages
- b) Number of reminders
- c) Number of urgent messages
- d) Number of messages needing a callback
- e) Number of private messages
- f) Number of fax messages

## 2

### RECORD AND SEND A MESSAGE

This option is used to send a message to another subscriber. The steps are simple:

- a) Enter the recipient's mailbox number, or if this is not known enter [#] to use the system directory.

b) Record your message at the tone. After recording the message, you will hear the Send Menu with the following functions:

- 1 Review
- 2 Continue Recording
- 3 Discard and Re-Record
- 4 Set Message Attributes (Delivery Options)
- 5 Schedule Future Delivery
- 6 Save and Send then Send a Copy to Someone Else
- # Save and Send the Recording

## Setting Message Attributes

If after recording a message you select [4] you can set up any combination of the following delivery options:

- 1 Urgent Delivery
- 2 Return Receipt Requested
- 3 Request a Call Back
- 4 Private Delivery
- 5 Reply Required
- \* Exit

## Scheduling Future Delivery

If after recording a message you select [5] to schedule future delivery, you will be able to set message attributes and set this message as:

- # Immediate Delivery
- 1 Next Few Hours
- 2 End of Current Business Day (based on your Availability Schedule)
- 3 Beginning of Next Business Day (based on your Availability Schedule)
- 4 A Coming Day of the Week
- 5 Specific Day / Time
- \* Exit

# 4

## ACCESS MANAGER

The Access Manager allows the subscriber to set a number of options for when, where and how, and/or if the Samsung Voicemail contacts you when a caller dials your extension number. All of the options are toggled on/off based on their current status when you access them.

**Note: ALL** Access Manager options **MUST** be individually allowed by the System Administrator for each Subscriber. They are:

### 1 Follow Me

Allows the subscriber to enter an alternate location and set how long the new destination (Designated Location) will be active. This number may be an internal or external number. This is useful if you are frequently traveling or changing the number where you can be reached.

When Follow Me is activated, the transfer will be supervised and confirmed. This means that if the call is not answered or if rejected by the Subscriber at the designated location it will be recalled to the Subscriber's mailbox.

### 3 Call Blocking

When this feature is active, callers will not be transferred to your extension, they will hear your 'blocked' greeting (if recorded) and will go directly to your mailbox if they do not select any or are not offered any other options.

### 4 Call Forwarding

Unlike Follow Me where the subscriber wants to take their calls at an alternate location this feature allows the subscriber to pass control of his calls to another Subscriber. The "Forwarded To" Subscriber will now be in control of the caller and the caller will NOT return to originating Subscriber's Mailbox. If the "Forwarded To" Subscriber does not answer the caller it will now follow what ever the "Forwarded To" Subscriber has set up for their call conditions. The Caller will hear "Forwarding to" "{Subscriber Name}" before actually being forwarded.

### 5 Call Screening

If this is turned on, the caller will be asked their name and the Samsung Voicemail will play this name to you before the transfer, giving you an option to accept or reject the call.

### 6 Find Me

Find Me, when enabled, will attempt to locate the subscriber by calling a list of preprogrammed phone numbers. The stored phone numbers are entered in 'Personal Services' [#][2] (if allowed by the Administrator). The stored telephone number list can contain up to 9 preprogrammed telephone numbers. The Find Me feature only use the first five.

### 7 Night Intercept

This feature is dependent on your weekly availability schedule, which is entered in 'Personal Services' [#][3] (if allowed by the Administrator). When Night Intercept is active the Samsung Voicemail will first ring your extension 0 then play your primary, No Answer greeting during the day (when you are



available) and will NOT ring your extension but simply play your Night greeting during the night (when you are not available).

**Note:** This does NOT use the Day and Night schedules of the phone system. It is solely controlled by the Subscriber's Availability Schedule.

## 8 Pause / Resume

## \* Exit from Access Manager

## 0 Play All Options

## # Play Access Coverage

This feature is useful for finding out how your current access settings are set. It will also tell you what greetings will play under each of the call conditions you have setup.

# 5

## PERSONAL GREETINGS

The options available in this menu will be determined by your System Administrator, and not all of them may be available to you. In the simplest systems, only a mailbox greeting will be available, additional greetings may be accessible in more complex systems.

Your Personal Greeting will be played every time someone dials your extension and you do not answer.

You may record up to 9 Personal Greetings, and you may assign any one of them to be active. There are several different 'Call Coverage' conditions to which you may assign any of your 9 greetings. The Call Coverage Conditions are: No-Answer, Busy, and Do Not Disturb (or Forwarded All). This will allow different greetings to play depending on the type of call forward that you have set, or the condition of your telephone.

The Call Coverage conditions that you can assign specific greetings to are selected by the following digits:

### 1 Primary/No Answer Greeting

Used when in your office, away from your desk or during the time period you are scheduled available. If this is the only Personal Greeting you record, it will play for all call coverage conditions.

This option is available only if the Administrator has assigned you the 'Basic Greeting' feature.

Example: "Hi this is John Smith. I'm sorry I am not available to answer your call. If someone else can help you, please enter the extension number now. Or, to leave me a message, press 1."

### 2 Busy Greeting

Played to a caller when you are already talking to someone on your extension or the telephone at your Designated Location.

This option is available only if the Administrator has assigned you the 'Busy Greeting' feature.

Example: "Hi, this is John Smith. I'm on another line right now. If someone else can help you, please enter the extension number now. Or, to leave a message, press 1."

### 3 Call Blocking Greeting

Used while Call Blocking is enabled in your Access Manager or if your phone is forwarded ALL or DND.

This option is available only if the Administrator has assigned you the 'Call Blocking' feature.

Example: "Hi, this is John Smith. Sorry I missed your call, but I'm going to be out of the office for the next few hours. If someone else can help you, please enter the extension number now. Or, to leave me a message, press 1."

### 4 Night Greeting

Used during the time period you are scheduled UNAVAILABLE, usually after business hours during the evening and at night.

This option is available only if the Administrator has assigned you the 'Scheduling' feature.

Example: "Hi, this is John Smith. I've left the office for the evening. If you would like to try someone else, please enter the extension number now. Or, to leave me a message, press 1."

### 5 Call Screening Greeting

Used while Call Screening is enabled, and you REJECT a caller after listening to the caller's record name.

This option is available only if the Administrator has assigned you the 'Call Screening' feature.

Example: "Hi, this is John Smith. I'm sorry, but I am not available to speak with you at this time. If someone else can help you, please enter the extension number now. Or, to leave me a message, press 1."

## 6 Edit Personal Greetings

You may also edit/record each one of the greetings (1-9) at any time.

Select a greeting number to edit and follow the instructions to record your greeting. When you are done recording your greeting, you will be able to listen to the greeting you recorded, save the greeting you recorded and return to the previous menu, record the greeting again, or exit without saving the greeting.

Note: If you record only the greeting assigned to the No-Answer Call Coverage Condition, then that greeting will play to callers for all Call Coverage Conditions (No-Answer, Busy, Blocked, Night, and Rejected Caller). In this case, the salutation part of the greeting should be very general.

## 7 Edit Mailbox Greeting

Used whenever a caller reaches your mailbox or if you have not recorded any of the Call Coverage greetings. The way a caller is transferred to your mailbox greeting directly, is by another subscriber transferring the caller to your mailbox using the VT (Voicemail Transfer) key.

This option is available only if the Administrator has assigned you the 'Mailbox Greeting Option' feature.

Example: "Hi, this is John Smith. Please leave me a message, I will call you as soon as I can."

Note: This greeting will only play if none of the 5 personal greetings has played to the caller. A common usage for this Greeting is when another Subscriber is talking with a caller and uses the VT key on their phone to transfer the caller directly to your Mailbox.

# 6

## MAILBOX ADMINISTRATION

The Mailbox Administration menu is used to turn on and off your pager notification, message alert options and other message control features.

### 1 Message Alert

When this function is activated, the Samsung Voicemail will call any outside or inside telephone number, after each message is left in your voice mailbox.

To hear your message at the remote location when the Samsung Voicemail calls you, after you pick up the telephone and answer you will be instructed that there is a message and to enter your password. Simply enter your password and you will now be logged in.

### Setting Up Message Alert:

- From the Subscriber Services Menu press **[6]** for Mailbox Administration.
- Press **[1]** for Message Alert.
- There are 4 options available to you:
  - Press **[1]** to toggle message alert on and off.
  - Press **[2]** to set the schedule when you would like to be notified.
  - Press **[3]** to be notified on urgent messages only.
  - Press **[4]** to set the destination phone number.

### 2 Pager Notification

When this function is activated, the Samsung Voicemail will call your beeper service and notify you after each message is left in your voice mailbox.

- From the Subscriber Services Menu press **[6]** for Mailbox Administration.
- Press **[2]** for pager notification.
- There are 4 options available to you:
  - Press **[1]** to toggle pager notification on and off.
  - Press **[2]** to set the schedule when you would like to be paged.
  - Press **[3]** to be notified on urgent messages only.
  - Press **[4]** to set the pager phone number.

### 3 Undelete

When this function is activated, the Samsung Voicemail will allow you to undelete any messages that you have recently deleted (up to the programmed Daily Maintenance Time, which is set to 3 a.m. by Default the following morning).

- From the Subscriber Services Menu press **[6]** for Mailbox Administration.
- Press **[3]** for Deleted Messages.

Deleted voicemail messages are temporarily stored in memory until 3 a.m. the following day. Select this option to recover ("undelete") previously deleted messages, during this period of time.

### 4 Undelivered Retrieval

When this function is activated, the Samsung Voicemail will allow you to recall any messages you have sent that have NOT yet been picked up by the recipient.

- From the Subscriber Services Menu press **[6]** for Mailbox Administration.
- Press **[4]** for Undelivered Messages.

This useful feature will allow you to cancel any messages that have NOT yet been picked up by the recipient.

### 5 Auto Play New Messages

If this option is enabled, after you enter your password correctly any new messages will immediately begin to play. To enable (or if already enabled toggle and disable) this feature:

- From the Subscriber Services Menu press [6] for Mailbox Administration.
- Press [5] to Set Auto Play of New Messages.

### 6 Auto Play Message Information

If this option is enabled, the date, time and sender's name will be played automatically before each message. If this is disabled, the information must be requested manually by pressing '00'. To enable (or if already enabled toggle and disable) this feature:

- From the Subscriber Services Menu press [6] for Mailbox Administration.
- Press [6] to Set Auto Play of Message Information.

## 9

## MESSAGE BROADCAST

This option will only be available if it has been allowed by the System Administrator.

### Broadcast to All Mailboxes

If you have been designated as a Subscriber Administrator, you may send a message to ALL mailboxes in the system.

- From the Subscriber Services Menu press [6] for Mailbox Administration.
- Press [9] for Broadcast Messages.

This option will only be available if your mailbox has been assigned Subscriber Administration privileges.

## #

## PERSONAL SERVICES

The Personal Administration Menu is used to set your password and record your name. Many of these features must be allowed by the System Administrator.

### 1 Workload Management

Allows you to access to all reminders, both Active and Pending. If authorized you can group your reminders as Commitments, Follow-Ups or Tasks for better organization. The system will flag each reminder as Active or Pending (pending means scheduled for future delivery).

### 2 Stored Numbers

Allows you to enter up to 9 stored phone numbers. The first five of these are used in the 'Find Me' feature, but any of them (1-9) can be easily dialed using only one digit followed by the pound key, to be used by many other features from within your subscriber space. (ie: "Follow Me", "Message Alert", "Pager Alert", and "Direct Call").

### 3 Schedule Availability

Allows you to enter a weekly availability schedule for use with Night Personal Greeting and the Auto Night Intercept feature. Follow the spoken directions to enter the days of the week and times you are generally available to talk to your callers. All other times you will be considered unavailable.

### 5 Place a Direct Call

Allows you to place a direct call out of the Samsung Voicemail from anywhere. You may either dial the number or dial a single digit 1-5 that corresponds to a stored number ([See Personal Services, 2 - Stored Numbers](#)). This feature must be authorized by the System Administrator and can be limited or opened to internal, local, and long distance calls.

### 7 Personal Administration

This area is used during the initial set up of your Subscriber Settings ([see next section](#)).

## PERSONAL ADMINISTRATION SETTINGS

This menu allows you to make changes to basic setup settings, that are rarely changed. Use these when you initially set up your personal Subscriber settings. You probably will not need to change them after that.

### 1 Setting your Password

- From the Subscriber Services Menu press **[#][7][1]**.
- The current password will be played and you will have the chance to change it.

### 2 Recording your Name

Use this option to record your name. Your recorded name is played in several different situations. It is important to record your name for proper operation of the Samsung Voicemail system.

- From the Subscriber Services Menu press **[#][7][2]**.
- The current name will be played and you will have the chance to change it.

Note: It is possible that if you do not record your name and/or enter your Directory Name (described below), you will not be included in the Dial by Name Directory.

### 3 Entering your Directory Name

Use this option to enter your Directory Name. Your Directory Name is used by callers to find you if they do not know your extension number.

- From the Subscriber Services Menu press **[#][7][3]**.
- The current Directory Name will be played as a string of digits that are equal to your name spelled out on your telephone keypad. Follow the instructions to enter a new name. You will be prompted to enter your last name and then your first name.

This must be done in order for the directory feature to work correctly.

Note: It is possible that if you do not record your name (described above) and/or enter your Directory Name, you will not be included in the Dial by Name Directory.

### 4 Extended Prompting

Use this option to drastically reduce the number of prompts played in the subscriber interface (mailbox prompts). Change this setting only if you are very familiar with the user operation of the Samsung Voicemail.

Note: Remember if you know what digits to press, you can enter them at any time you do not have to wait to be prompted. This feature can be toggled on/off at anytime. Also if it is off you will be prompted within each subscriber menu to press zero for more options. This enables you to still be able to find out what to do if you were to get lost and extended prompting was disabled.

## KEYSET USER FEATURES

The following options are available if you have a display keyset. They require setup by the System Administrator.

### Message Waiting Lights

When new messages are left in your mailbox, the voicemail message light on your keyset will flash. Press this flashing key **[VMMMSG]** and follow the prompts to retrieve messages. This key may be pressed at any time to log into your Subscriber Main Menu.

### Answer Machine Emulation

If you have an Answer Machine Emulation key programmed on your keyset, you can use it to monitor calls going to your voicemail, and optionally answer them. The operation of this feature is similar to screening a call on a home answering machine.

Your keyset must be set to forward on no answer to voicemail. After ringing your station the caller will be connected to your voicemail and hear your personal greeting before leaving a message. During this time you will be monitoring the connection between the caller and your voicemail box. At this time you will only be monitoring the call, you can not talk to the other party until you answer. You may pick up the call at any time or ignore it.

To activate this feature press the **AME** button. The associated indicator will be lit steady. Press again to turn off. If this key is pressed while a station is ringing (during forward no answer), the feature will be turned on for the current call only.

While the caller is leaving a message or ringing you may:

- Press **[#]** to immediately put the caller in your voice mailbox and monitor it.
- Press **[\*]** to immediately disconnect your station. The caller continues to leave a message normally.
- Pick up the handset and monitor privately.
- Press **ANS / RLS** to answer the call (using the handset or speaker).

## AME Password

If your keyset has **AME PASSWORD** (MMC 110) set to **YES**, you must enter your station password to listen to messages being left. This will prevent unauthorized people from listening to messages being left for you.

If the password option is turned on, while a message is being left, press the flashing **AME** indicator and enter your station password (not your Samsung Voicemail password). You will then hear the message being left.

## Call Record

If you have a call record button assigned to your phone, you may press it at any time, to record the conversation in progress. If you have a display keyset, you will also have the soft key options to pause and time the message.

## SHORTCUTS

### Calling

Calling a station that is busy or does not answer you can press **[#]** to immediately send the call to the called parties mailbox.

### Call Divert to Voicemail

While receiving an incoming (ringing) call, dial **[\*]** to immediately send the caller to your personal voicemail box. This will override the call forward no answer setting.

### Direct Messaging

**[#] + DSS** To make it easy to leave messages for others in your office without having to dial their extension number first, keyset users may simply dial **[#]** plus a mailbox (extension) number and leave a message directly. If you dial a busy extension press **[#]** to connect directly with the mailbox.

### Self Memo (Reminder)

Pressing **[##]** will leave a message in your own mailbox. This is useful to remind yourself of things to do now or in the future. Messages can be sent with future delivery so you can have the system call you when items become due.

## INTERACTIVE DISPLAYS

Display keyset users have the added advantage of using the soft keys and displays to play, save, delete, reply, call, forward, rewind, pause, fast forward, change the volume, get message information, or help.

### Viewing Mailbox Contents

If you have new messages, in addition to the Terminal Status Indicator (TSI) you will be able to use the keyset displays and soft keys to communicate with the Samsung Voicemail.

## E-MAIL GATEWAY (EMG)

The E-Mail Gateway feature integrates your voicemail box with your email client. No matter what email client software you are using or where you use it, you can send voicemail messages and fax mail messages to your E-Mail inbox.

There are two parts to the E-Mail Gateway; E-Message Delivery and E-Message Notification.

1. **E-MESSAGE DELIVERY:** Voicemail messages (.wav) and/or fax mail messages (.tiff) are "delivered" to your Inbox with the appropriate attached file.
2. **E-MESSAGE NOTIFICATION:** You will receive an e-mail, with NO attachments, notifying you that you have a voice and/or fax mail message in your Voicemail Box.
  - As a subscriber you can use either E-Message Delivery and/or E-Message Notification.
  - As a subscriber you can have multiple e-mail addresses. (a maximum of 5 valid email addresses).
  - E-Message Notification can be set to one e-mail address while E-Message Delivery is set to different e-mail address.

## Functionality

- With either type of EMG, when Caller ID (CID) is provided, the callers telephone number will appear in the subject field of the email along with the date and time stamp of when the voice message was originally recorded in your Voicemail Box.
- If the caller is also a subscriber on the system and the E-Mail Gateway is set up with a valid "Reply To" address, the Subscriber's name will also appear in the "From" field. Otherwise, the "From" field will display the name of the Samsung voicemail system sending the message.
- Client will use their PC's Multi-Media kit (equipped with either speakers and/or a headset) to listen to messages delivered to their e-mail Inbox.

**IMPORTANT NOTE:** If the PC/Laptop/PDA/Smart Phone/etc... is not equipped with hardware and software capable of playing a '.WAV' file then the E-Mail Gateway will not work for them until they add some method to listen to '.WAV' files delivered to their Inbox.

The same applies to Fax Mail messages, if the device the subscriber is using does not support the viewing of '.TIFF' files, then the E-Mail Gateway for Fax Mail will not work for them until they add some method to view .tiff files delivered to their inbox.

- No Synchronization of messages is performed between the Voicemail Box and the E-mail Inbox.
  - Messages listened to, forwarded, deleted, and/or saved within an e-mail inbox will NOT effect the status of that same new message in the Voicemail or the MWI (Message Waiting Indicator) associated with that message on the phone.
  - Also messages listened to in the Voicemail, from a phone, will not change the Unread/Read status of the same message in an e-mail inbox.

- However, the Voicemail Administrator can adjust parameters per subscriber or group of subscribers that decide how, when, or if to delete the original voice message after it is sent to the E-Mail Server.
- When full synchronization of messages between Voicemail Box and E-mail Inbox is required, ask your Samsung representative about the OfficeServ IP-UMS. This is an Internet Protocol based fully synchronized Unified Messaging System.

## Benefits

- Store and Archive Voice and Fax Mail Messages in visible folders.
- Voice and Fax Mail Messages can now easily be dragged and dropped into folders the same way e-mail messages are organized and saved.
- Voice and Fax Mail Messages are now essentially the same as any other e-mail message.
- Backups and Message Archives can be made when they are made for all other types of e-mail messages.
- Add text notes and comments to use for reference later.
- Some (if not all) e-mail clients will allow you to edit the body of the e-mail to add comments.
- Some will allow you to edit the subject field to help you find a particular message quickly in a large archive of messages.
- Call Back Numbers and Date & Time Stamp are easily displayed in the Subject field.
- Easily forward Voice messages received, to others even if they are not a Voicemail Subscriber on your system.
- No EMG System or Client Software to load on your Local PC or Network Servers.

Therefore compatible with most:

- E-Mail providers and E-Mail Clients
- PCs, Laptops, PDA, and/or Smartphones

**NOTE:** If you are not sure you have this functionality on your system and you would like to use it, please contact your on Site system administrator to see if it is available.

## PERSONAL SPEED DIAL NUMBERS

CODE	NAME	TELEPHONE NUMBER
00	_____	_____
01	_____	_____
02	_____	_____
03	_____	_____
04	_____	_____
05	_____	_____
06	_____	_____
07	_____	_____
08	_____	_____
09	_____	_____
10	_____	_____
11	_____	_____
12	_____	_____
13	_____	_____
14	_____	_____
15	_____	_____
16	_____	_____
17	_____	_____
18	_____	_____
19	_____	_____
20	_____	_____
21	_____	_____
22	_____	_____
23	_____	_____
24	_____	_____

## PERSONAL SPEED DIAL NUMBERS

CODE	NAME	TELEPHONE NUMBER
25	_____	_____
26	_____	_____
27	_____	_____
28	_____	_____
29	_____	_____
30	_____	_____
31	_____	_____
32	_____	_____
33	_____	_____
34	_____	_____
35	_____	_____
36	_____	_____
37	_____	_____
38	_____	_____
39	_____	_____
40	_____	_____
41	_____	_____
42	_____	_____
43	_____	_____
44	_____	_____
45	_____	_____
46	_____	_____
47	_____	_____
48	_____	_____
49	_____	_____

# NOTES

## FEATURES AND SPECIFICATIONS

### LINE GROUPS

9 Local/LCR \_\_\_\_\_  
 800 \_\_\_\_\_  
 801 \_\_\_\_\_  
 802 \_\_\_\_\_

### STATION GROUPS

501 \_\_\_\_\_  
 502 \_\_\_\_\_  
 503 \_\_\_\_\_  
 504 \_\_\_\_\_

### PAGING ZONES - DIAL 55 PLUS

0 \_\_\_\_\_  
 1 \_\_\_\_\_  
 2 \_\_\_\_\_  
 3 \_\_\_\_\_  
 4 \_\_\_\_\_  
 5 \_\_\_\_\_  
 6 \_\_\_\_\_  
 7 \_\_\_\_\_  
 8 \_\_\_\_\_  
 9 All External Zones  
 \*All External Zones and Internal Zone 0

### PROGRAMMED MESSAGES

01 In A Meeting  
 02 Out On a Call  
 03 Out To Lunch  
 04 Leave A Message  
 05 Page Me  
 06 Out Of Town  
 07 In Tomorrow  
 08 Return Afternoon  
 09 On Vacation  
 10 Gone Home  
 11 \_\_\_\_\_  
 12 \_\_\_\_\_  
 13 \_\_\_\_\_  
 14 \_\_\_\_\_  
 15 \_\_\_\_\_  
 16\* \_\_\_\_\_  
 17\* \_\_\_\_\_  
 18\* \_\_\_\_\_  
 19\* \_\_\_\_\_  
 20\* \_\_\_\_\_

\*Programmed Messages 16-20 not available on the OfficeServ 7030, 7100, or 7200-S.

### FEATURE ACCESS CODES

10 + xxx	Pick Up A Parked Call
12 + xxx	Pick Up A Held Call
13	Door Lock Release
16 + xxx	Speed Dialing
17	Save And Redial Number
18	New Call (Recall)
19	Last Number Redial
400	Cancel Do Not Disturb
401	Set Do Not Disturb
42 + xxx	Cancel Message You Left
43	Return Message
44	Callback
45	Busy Station Camp-On
46	Conference
47	Account Code
48 + xx	Cancel Programmed MSG
49	Send Flash To C.O. or PBX
56	Meet Me Answer
600	Cancel All Call Forward
601 + xxx	Set Forward All Calls
602 + xxx	Set Forward Busy
603 + xxx	Set Forward No Answer
604 + xxx	Set Fwd Busy/No Answer
605 + xxx	Set Forward on DND
606 + xxx	Set Forward Follow Me
65 + xxx	Pick Up Ringing Extension
66 + xx	Pick Up Group
67	Universal Answer
*	Authorization Code



[www.samsung.com/bcs](http://www.samsung.com/bcs)



# DCS KEYSET USER GUIDE

for  
OfficeServ™ 100, OfficeServ™ 500  
and OfficeServ™ 7000 Series

*December 2009*

Samsung Telecommunications America reserves the right without prior notice to revise information in this guide for any reason. Samsung Telecommunications America also reserves the right without prior notice to make changes in design or components of equipment as engineering and manufacturing may warrant. Samsung Telecommunications America disclaims all liabilities for damages arising from the erroneous interpretation or use of information presented in this guide.

# TABLE OF CONTENTS

<b><u>ABOUT THIS BOOK</u></b> .....	1
-------------------------------------	---

<b><u>THINGS YOU SHOULD KNOW</u></b> .....	2-9
--	-----

## **OUTSIDE CALLS**

Making an Outside Call .....	10
Answering an Outside Call .....	10
Universal Answer .....	11
Recall/Flash .....	11
Busy Line Queuing with Callback .....	11
Cancelling Callback.....	12

## **INTERCOM CALLS**

Calling Other Stations .....	13
Answering Intercom Calls .....	13
Answer Modes .....	14
Busy Station Callback.....	14
Busy Station Camp-on.....	14
Calling Your System Operator.....	15

## **CALL PROCESSING**

Holding Calls .....	16-17
Transferring Calls .....	18-19
Transfer with Camp-On .....	18
Transfer to Voicemail .....	19
Call Waiting .....	19
Conference Calls .....	19
Forwarding Calls.....	20-22
Call Pickup .....	23
My Group Pickup.....	23
Privacy Release .....	23

## **DIALING FEATURES**

Speed Dialing .....	25
Programming Personal Speed Dial Numbers .....	25-26
One Touch Speed Dialing.....	26
Last Number Redial .....	27
Manual Retry with LNR .....	27
Save Number with Redial .....	27
Chain Dialing.....	27
Automatic Redial/Retry.....	28
Pulse to Tone Changeover .....	28
Memo Redialing.....	28

## **PAGING AND MESSAGING**

Making an Internal Page.....	29
Making an External Page .....	29
All Page .....	29
Meet Me Page.....	30
Call Park and Page .....	30-31
Messages—Set and Cancel .....	31
Returning Messages .....	32
Programmed Messages.....	32

## **CONVENIENCE FEATURES**

Do Not Disturb .....	33
One Time DND .....	33
Mute .....	33
Background Music .....	33
Established Call Pick-Up .....	34
Appointment Reminder/Alarm Clock .....	34
Door Phone Calls .....	35
Executive/Secretary Hot Line .....	35
Group Listening .....	36
Account Codes .....	36
Locking Your Keypad .....	37
Manual Signalling .....	37
Off-Hook Voice Announce .....	38
OHVA Block .....	39
OHVA Reject .....	39
In Group/Out of Group .....	39

## **CUSTOMIZING YOUR KEYSSET**

<a href="#">AME PASSWORD</a>	40
<a href="#">Auto Camp-On</a>	40
<a href="#">Select Ring Tone</a>	40
<a href="#">Change Your Passcode</a>	40
<a href="#">Set Answer Mode (Intercom)</a>	41
<a href="#">Set Answer Mode (CO)</a>	41
<a href="#">Automatic Hold</a>	41
<a href="#">Headset Operation</a>	41
<a href="#">Hot Keypad</a>	42
<a href="#">Key Confirmation Tone</a>	42
<a href="#">Rejoining a Page</a>	42
<a href="#">Ring Preference</a>	42
<a href="#">Display Speed Dial Name</a>	43
<a href="#">Caller ID Review All</a>	43
<a href="#">Secure OHVA</a>	43
<a href="#">Configure Mobile Extensions (MOBEX)</a>	43

## **DISPLAY FEATURES**

<a href="#">Interactive Display Keys</a>	45
<a href="#">Directory Information</a>	45
<a href="#">Call Log</a>	46
<a href="#">Dial by Name</a>	46
<a href="#">Call Progress Displays</a>	46
<a href="#">Display Number Dialed</a>	47
<a href="#">Call Duration Timer</a>	47
<a href="#">Auto Timer</a>	47
<a href="#">Timer Function</a>	47
<a href="#">Viewing Message Indications</a>	48
<a href="#">Alarm Reminder Messages</a>	48
<a href="#">Personal Speed Dial Names</a>	49
<a href="#">Station Names</a>	49
<a href="#">Managing Key Assignments</a>	49
<a href="#">LCR with Clear</a>	50
<a href="#">Backspace with LCR</a>	50
<a href="#">Text Messaging</a>	51–52
<a href="#">Caller ID / ANI / CLI</a>	53–57

## **ADD-ON MODULE**

<a href="#">32 Button Module with Keypad / 64 Button Module with Keypad</a>	58
---	----

## **Samsung Voicemail**

<a href="#">Subscriber Services Menu Diagram</a>	60–61
<a href="#">Accessing your Mailbox</a>	62
<a href="#">Getting Started</a>	63
<a href="#">Listen to your Messages</a>	64
<a href="#">Subscriber Services Menu</a>	63
<a href="#">Listening to Old or New Messages</a>	64
<a href="#">Group New or Old Messages</a>	65
<a href="#">Record and Send a Message</a>	65
<a href="#">Access Manager</a>	66
<a href="#">Personal Greetings</a>	68
<a href="#">Mailbox Administration</a>	70
<a href="#">Message Broadcast</a>	72
<a href="#">Personal Services</a>	73
<a href="#">Personal Administration Settings</a>	74
<a href="#">Keypad User Features</a>	75
<a href="#">Shortcuts</a>	77
<a href="#">Interactive Displays</a>	77
<a href="#">E-Mail Gateway (EMG)</a>	77-79

## **PERSONAL SPEED DIAL NUMBERS**

80–81

## ABOUT THIS BOOK

Your keyset is the most visible part of the OfficeServ System. No matter what model keyset you are using, with or without a display, telephone calls are handled in the same way. The LCD 12B and LCD 24B keysets have a few additional conveniences that are not available to STD 24B, Basic 12B and 7B keyset users. These are noted throughout this guide.

Please take the time to study this guide and to become familiar with the operation of your keyset. Keep this guide handy. You may need to look up instructions for infrequently used features.

Learning to use your keyset correctly will make everyday telephone communications a breeze.

This book is written based on the factory default settings for the feature access codes. Sometimes, due to programming requirements, these codes may be changed. If you find that a feature code does not work as described in this book, please contact your installation and service company to determine the correct code.

# THINGS YOU SHOULD KNOW

## USER ORIENTATION

DCS telephones are called “keysets.” They contain buttons or “keys” that are used to access or activate the many features of your office phone system. The keys with paper designation strips are programmable keys. This means they can be programmed for a specific function on your keyset and that same button can be something different on another keyset. See the system manager to get your most frequently used features assigned to your programmable keys. When changes are made, be sure that your programmable keys are relabeled properly.

Lines from the telephone company are “C.O. lines.” Calls on these lines are referred to as “outside calls.” Your system can have individual C.O. line keys or lines may be assigned to groups. When they are in a group, you access a line by dialing an access code or pressing a route button. For example, dial **9** or press the **LOCAL** key to get a local outside line. If Least Cost Routing is used, pressing the **LCR** key will automatically select a preprogrammed C.O. line according to what digits are dialed. Each line in the system is numbered, beginning with 701, then 702, 703, etc.

Direct Station Selection (DSS) keys are programmed to ring specific stations. You can press a DSS key instead of dialing the extension number. A DSS key lights red when that station is busy (Busy Lamp Indication).

OfficeServ 100, OfficeServ 500, and OfficeServ 7000 Series systems provide distinctive ring patterns to your keyset:

- Outside calls have a single ring tone repeated.
- Internal calls have a double ring tone repeated.
- Door phone calls and alarm/appointment reminders have a triple ring tone repeated.

## CALL INDICATIONS

The keys on your phone have light emitting diodes (LEDs). Some of these are tri-colored LEDs that light green, red or amber (green and red together). Some of the keys can only light red.

Intercom calls, also called internal calls, always appear on your **CALL** buttons. They will always light green. You can have up to eight **CALL** buttons, but at least two are recommended.

Outside calls appear on individual line keys if they are assigned. When an individual line is not assigned to its own key, it will appear on a **CALL** button. Your outside calls will light green on your keyset and red on other keysets.

You never lose sight of your calls while they are on hold. They stay right where you put them and are identified with a green flashing light if the key has a tri-colored LED.

Some simple rules to remember:

- Any steady LED indicates the line or feature is in use.
- A fast flashing green LED indicates a new call ringing in.
- A slow flashing green or red LED indicates a call is on hold.
- A slow flashing amber LED indicates a recall to your keyset.
- A steady red LED on the HOLD key indicates the keyset is locked.
- A steady red LED on the TRSF key indicates the keyset is Forward All.
- A steady red LED on the ANS/RLS key indicates the keyset is in Headset mode.
- A flashing red LED on the ANS/RLS key indicates the keyset is in DND mode.

## SPEAKERPHONE

Pressing the **ANS/RLS** or the **MONITOR** key will answer or release a call on the speakerphone. Switching from the handset to the speakerphone is easy. Press the **SPK** key and hang up the handset.

NOTE: The 7B phone is not a speaker phone. If you are using a 7B phone, you must lift the handset in order to speak to the other party.

## VOLUME CONTROLS

DCS keysets use the **UP** and **DOWN** keys to adjust the ringer volume while the keyset is ringing, the speaker volume while the speakerphone or monitor speaker is in use and the handset volume while you are listening. These three levels will be stored in memory until changed. If background music is turned on at your keyset, the volume keys will also control the level of music. The volume of pages heard through the speaker of a keyset can be adjusted during a page announcement by using the volume keys. There are 16 levels for each volume setting. The volume of off-hook ring is controlled by a user-programmable setting.

# SYSTEM TONES

The system provides several tones to assist you. Some of these tones are already familiar to you.

**Intercom Dial Tone**—A steady tone that indicates you can begin dialing.

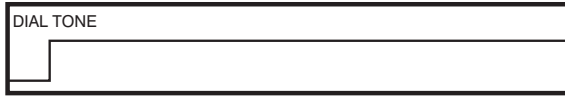

CONTINUOUS

**Ringback Tone**—Indicates the station you dialed is ringing.

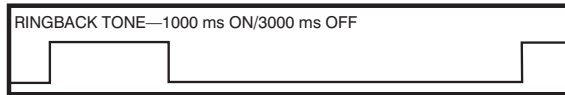

CONTINUOUS

**Busy Tone**—Indicates the station you dialed is busy.

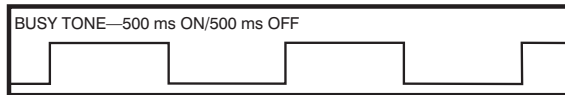

CONTINUOUS

**DND/No More Calls Tone**—Fast busy tone indicates the station you dialed is in the Do Not Disturb mode or cannot receive any more calls.

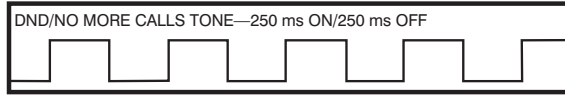

FOR TEN SECONDS

**Transfer/Conference Tone**—Indicates your call is being held and you can dial another party.

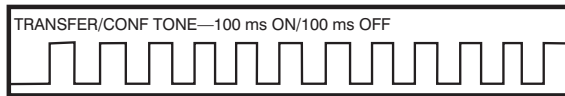

CONTINUOUS

**Confirmation Tone**—Very short beeps followed by dial tone indicate you have correctly set or canceled a system feature.

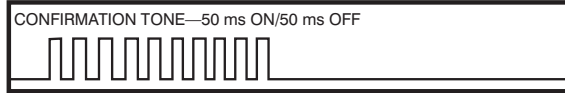

FOR ONE SECOND  
(programmable)

**Error Tone**—A distinctive two level beeping tone indicates you have done something incorrectly. Try again.

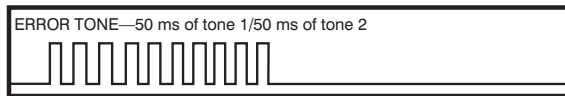

FOR THREE SECONDS

# LCD 24B KEYSET LAYOUT

## LABELING PROGRAMMABLE KEYS

Insert the end of a paper clip into the notch of the clear cover. Push the cover sideways. Lift the cover and remove the designation strip. Label the designation strip. Replace the strip and cover.

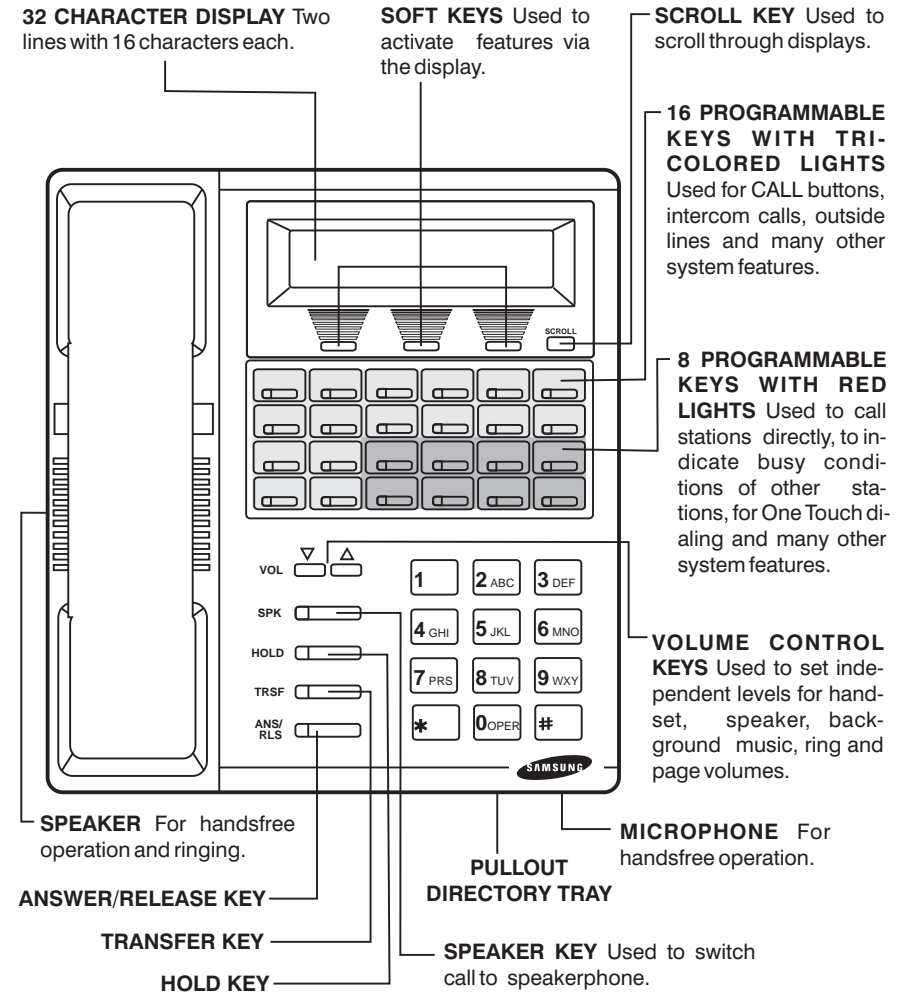

# LCD 12B KEYSSET LAYOUT

## LABELING PROGRAMMABLE KEYS

Insert the end of a paper clip into the notch of the clear cover. Push the cover sideways. Lift the cover and remove the designation strip. Label the designation strip. Replace the strip and cover.

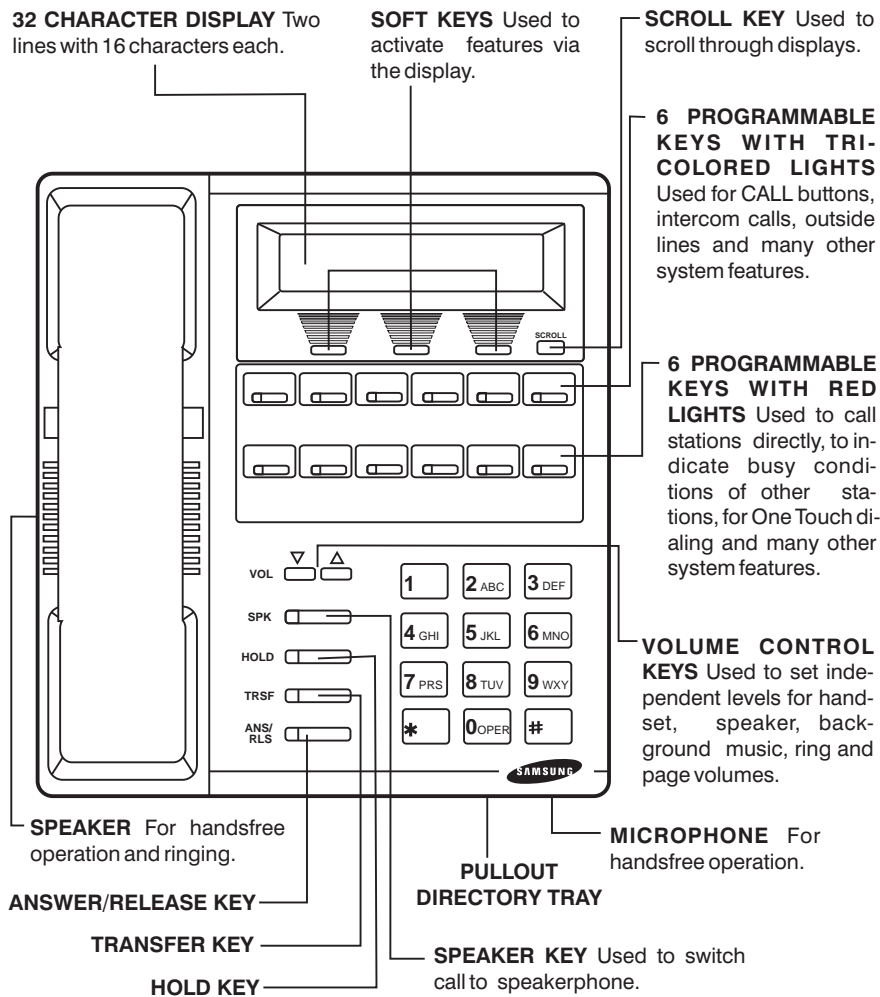

# STD 24B KEYSSET LAYOUT

## LABELING PROGRAMMABLE KEYS

Insert the end of a paper clip into the notch of the clear cover. Push the cover sideways. Lift the cover and remove the designation strip. Label the designation strip. Replace the strip and cover.

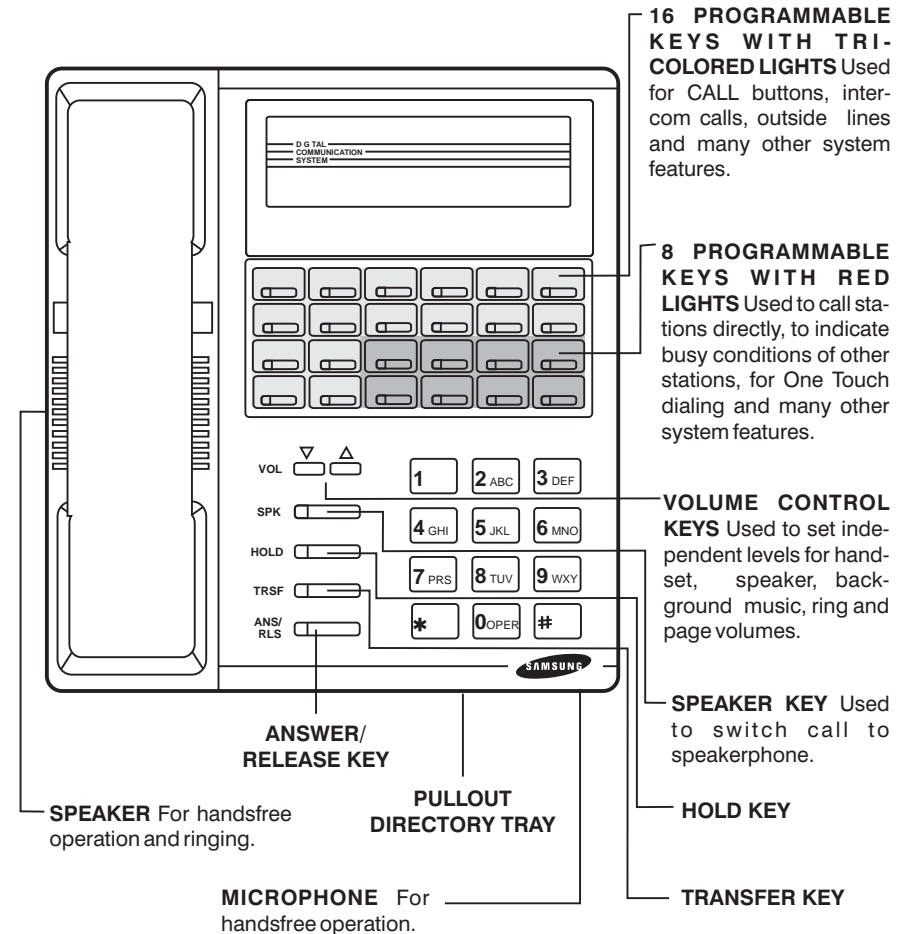

# BASIC 12B KEYSET LAYOUT

## LABELING PROGRAMMABLE KEYS

Insert the end of a paper clip into the notch of the clear cover. Push the cover sideways. Lift the cover and remove the designation strip. Label the designation strip. Replace the strip and cover.

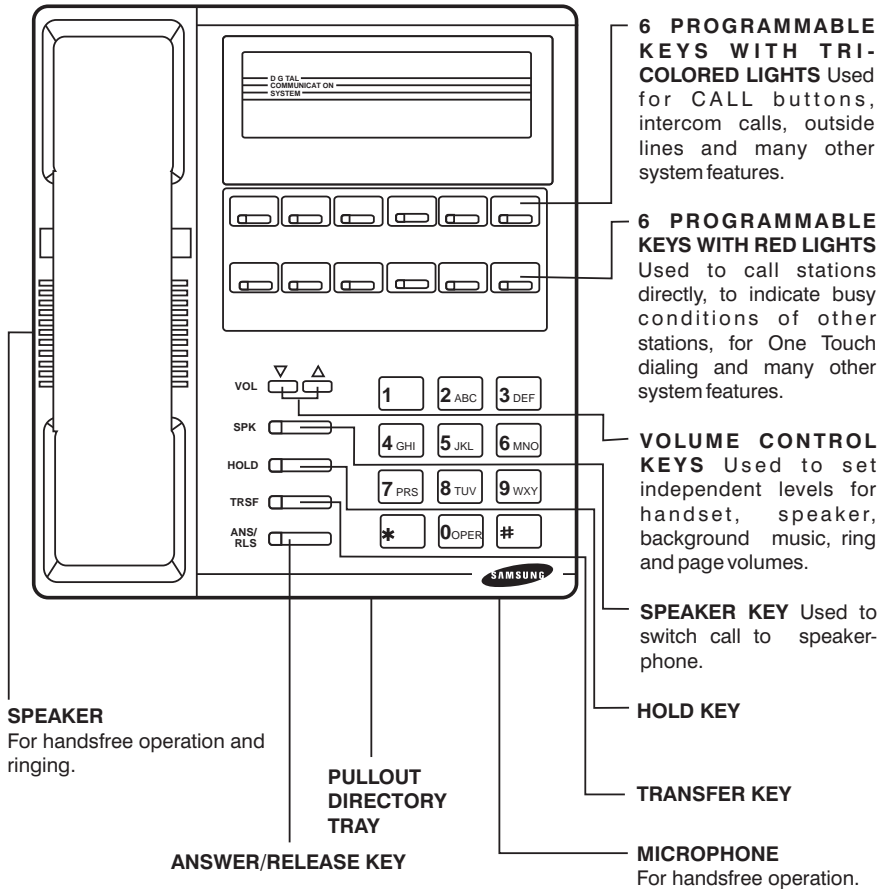

# 7B KEYSET LAYOUT

## LABELING PROGRAMMABLE KEYS

Insert the end of a paper clip into the notch of the clear cover. Push the cover sideways. Lift the cover and remove the designation strip. Label the designation strip. Replace the strip and cover.

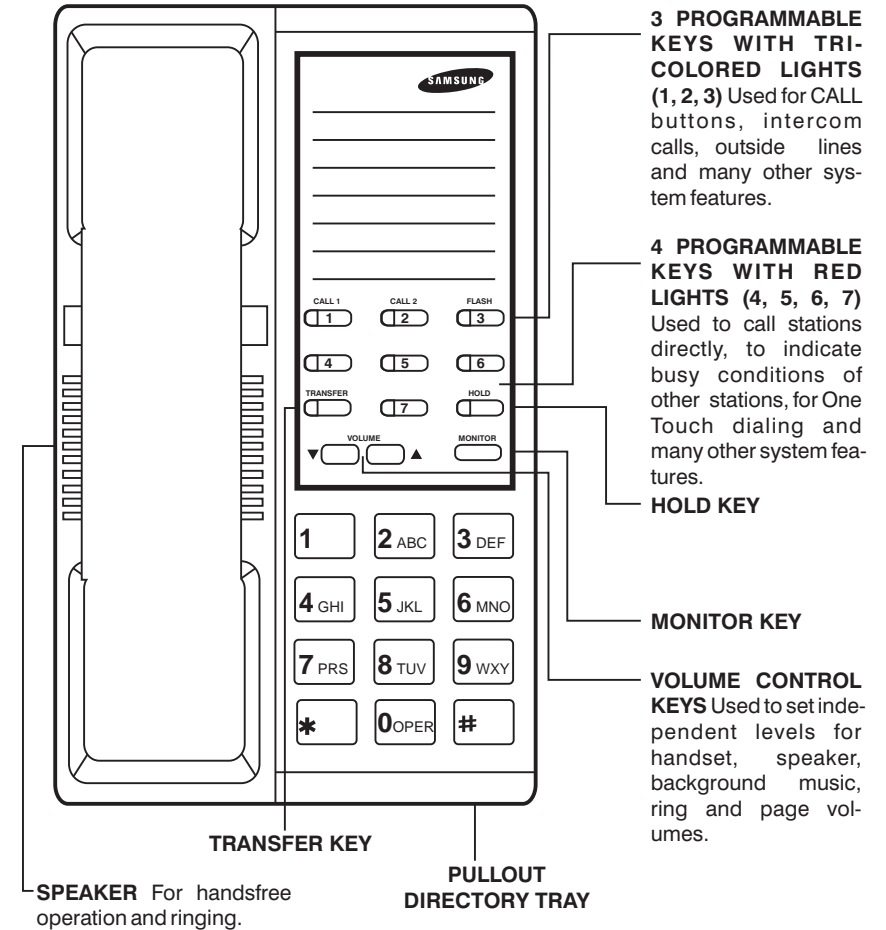



# OUTSIDE CALLS

## MAKING AN OUTSIDE CALL

- Lift the handset and press an idle outside line button, line group button or dial a line access code to receive dial tone—**OR**—to use the speakerphone, press an idle outside line button, line group button or dial a line access code to receive dial tone through the speaker—**OR**—press **SPK** or the **MONITOR** key if you are using a 7B phone, receive intercom dial tone and dial a line access code.
- Dial the telephone number.
- Finish the call by replacing the handset or pressing the **ANS/RLS** key.

NOTE: You will receive No More Calls tone when you attempt to make a call and there is no key available for that line.

- If Least Cost Routing is enabled on your phone system, this button may be labeled **LCR** or accessed by dialing an access code (usually **9**).
- If your system is programmed to require an authorization code before making a call, dial **\*** plus a valid code before selecting a C.O. line.
- If your system is programmed to require an account code before making a call, press the **ACCT** button or dial **47** plus a valid bin number, press the **ACCT** button again, or **\***, and then select a C.O. line.

For more information on authorization and account codes, see your system administrator.

NOTE: If the Hot Keypad feature has been turned off, you must first lift the handset or press **SPK** or the **MONITOR** key if you are using a 7B phone before dialing.

## ANSWERING AN OUTSIDE CALL

- Lift the handset and you are automatically connected to the ringing call.  
[See Ring Preference under Customizing Your Keypad](#)—**OR**—press the **ANS/RLS** key to automatically answer on the speakerphone.

NOTE: If a call is flashing at your keyset but not ringing, you must press the flashing button to answer.

## UNIVERSAL ANSWER

Outside lines may be programmed to ring a general alerting device. To answer calls ringing this device, dial **67** or press the **UA** key. This device can operate in any one of the six different ring plans.

NOTE: If the Hot Keypad feature has been turned off, you must first lift the handset or press **SPK** or the **MONITOR** key if you are using a 7B phone before dialing.

## RECALL DIAL TONE

Press the **NEW** button to disconnect your existing call, wait for dial tone and then make a new call on the same line.

NOTE: If this button does not appear on your keyset, the **FLASH** key may be programmed to recall dial tone.

## SENDING A FLASH

While on an outside call, press the **FLASH** key to send a flash to the telephone company. This is required for some custom calling features or CENTREX use.

NOTE: Flash is not available on an ISDN circuit.

## BUSY LINE QUEUING WITH CALLBACK

If you receive a busy signal when you are selecting an outside line, this means that the line or group of lines is busy.

- Press the **CBK** key or dial **44**. You will hear confirmation tone.
- When the line becomes free, the system will call you back.
- Lift the handset or press the **ANS/RLS** key to answer, wait for dial tone and dial the telephone number or speed dial number again.

NOTES:

1. A callback will be canceled if not answered within 30 seconds. If you have set a callback, your **CBK** key will light.
2. If the Hot Keypad feature has been turned off, you must first lift the handset or press **SPK** before dialing.

## CANCELLING CALLBACK

A callback will be canceled if not answered within 30 seconds. If you have set a callback, your **CBK** key will light.

Your phone may have a maximum of five callbacks to lines and/or stations set at a time. To cancel a callback:

- Press the **CBK** key or dial **44**. You will hear confirmation tone.
- While you are listening to confirmation tone, press the **HOLD** key. This will cancel the oldest set callback.

NOTE: If the Hot Keypad feature has been turned off, you must first lift the handset or press **SPK** or the **MONITOR** key if you are using the 7B phone before dialing.

## INTERCOM CALLS

### CALLING OTHER STATIONS

- Dial the extension number or group number.
- Wait for the party to answer. If you hear a brief tone burst instead of ringback tone, the station you called is set for Voice Announce or Auto Answer. Begin speaking immediately after the tone.
- Finish the call by replacing the handset or pressing the **ANS/RLS** or the **MONITOR** key if you are using a 7B phone.

NOTES:

1. If you have a DSS key assigned to an extension or station group, you may press this key instead of dialing the number. If you are using a 7 Button Set you must pick up the handset to speak to the calling party.
2. If the Hot Keypad feature has been turned off, you must first lift the handset or press **SPK** or the **MONITOR** key if you are using a 7B phone before you begin dialing.

### ANSWERING INTERCOM CALLS

- When your keyset rings, simply lift the handset—**OR**—press the **ANS/RLS** key to be connected to the calling station. If you are using a 7B phone you must pick up the handset to speak to the calling party.
- Finish the call by replacing the handset or pressing the **ANS/RLS** or the **MONITOR** key if you are using a 7B phone.

[See Ring Preference under Customizing Your Keypad.](#)

### VOICE ANNOUNCE MODE

When another station calls you, your keyset will sound a brief attention tone and you will hear the caller's announcement.

- Press **ANS/RLS** to turn on the microphone and speak handsfree—**OR**— lift the handset to reply.
- To finish the call, replace the handset or press the **ANS/RLS** key.

NOTE: In order for C.O. calls to be answered handsfree, AUTO ANS CO must be set to ON.

## AUTO ANSWER MODE

When another station calls you, your keyset will sound a brief attention tone and then automatically answer the call.

- Your microphone and speaker are turned on and you can speak handsfree. For privacy, use the handset. If you are using a 7B phone you must pick up the handset to speak to the calling party.
- To finish the call, replace the handset or press the **ANS/RLS** or the **MONITOR** key if you are using a 7B phone.

NOTE: In order for C.O. calls to be answered handsfree, AUTO ANS CO must be set to ON.

## BUSY STATION CALLBACK

When you call another station and receive a busy signal:

- Press the **CBK** key or dial **44**.
- When the busy station becomes free, your keyset will ring.
- Lift the handset or press **ANS/RLS** to call the now idle station.

NOTES:

1. A callback will be canceled if not answered within 30 seconds. If you have set a callback, your **CBK** key will light.
2. If the Hot Keypad feature has been turned off, you must first lift the handset or press **SPK** before dialing.

## BUSY STATION CAMP-ON

When you call another station and receive a busy signal but you do not want to wait for a callback:

### MANUAL CAMP-ON

- Press the **CAMP** key or dial **45**.
- The called station will receive off-hook ring tone repeated every few seconds and its first available **CALL** button will flash green to indicate your call is waiting.
- Wait for the called party to answer.
- The called station must release its first call or place it on hold before answering your camp-on.

NOTES:

1. If you receive No More Calls tone, that station has no available key to accept your call. Hang up or leave a message.

2. If the Hot Keypad feature has been turned off, you must first lift the handset or press **SPK** before you begin dialing.

### AUTO CAMP-ON

When you want to automatically camp on to a busy station without pressing the camp on button every time you call a busy station, you can set your phone for auto camp-on.

- With the handset on-hook, press **TRSF** and then dial **110**.
- Dial **081** to turn on auto camp-on or **080** to turn it off.
- Press **TRSF** to store your selection.

## CALLING YOUR SYSTEM OPERATOR

- Dial **0** to call your system operator or group of operators.
- If you want to call a specific operator, dial that person's extension number.

NOTE: If the Hot Keypad feature has been turned off, you must first lift the handset or press **SPK** before you begin dialing.

# CALL PROCESSING

## SYSTEM HOLD

- When you are connected to any call, press **HOLD**. The call will flash green at your keyset. If this call appears on a line key at other keysets, it will flash red at those keysets.
- To take the caller off hold, press that key and the green flashing light will go steady green again. Resume the conversation.

NOTE: While on a call, pressing a line key, route key or flashing **CALL** button will automatically put your first call on hold and connect you to the new call. [See Automatic Hold under Customizing Your Keyset.](#)

## EXCLUSIVE HOLD

To place an outside call on hold at your phone so that other users cannot get it:

- Press the **HOLD** button twice. The call will flash green on your keyset and this line will show a steady red light on other keysets.
- To retrieve the call, press the flashing green line button or press the **HOLD** button a third time.

NOTE: Intercom calls will always be placed on exclusive hold.

## REMOTE HOLD

When you wish to place a call on hold at another station. Press **TRSF** and dial the station number (or press the appropriate DSS key). Press the **HOLD** key. This will place the call on system hold on an available CALL button or Line Key at the remote station and return you to dial tone.

NOTES:

1. If the destination station does not have any free CALL buttons or line keys you will hear No More Calls tone and must return to the other party by pressing the TRSF key (or the RETURN soft key on a display keyset).
2. Intercom calls cannot be remote held.

## HOLD RECALL

If you leave a call on hold longer than the hold timer, it will recall your station. The button that the call appears on will have a slow flashing amber light.

- When your phone rings, lift the handset or press the **ANS/RLS** key to answer the recall. If you are using a 7B phone you must use the handset to talk to the calling party.
- If you do not answer this recall within a pre-programmed period of time, it will go to the system operator.

## CONSULTATION HOLD

When you are talking on an outside line and it is necessary to consult with another extension:

- Press the **TRSF** key; you will receive transfer dial tone. Your call is placed on transfer hold.
- Dial the extension number.
- Consult with the internal party.
- Press **TRSF** to return to the outside party or hang up to transfer the call.

NOTE: Repeatedly pressing the **TRSF** key will toggle between the outside party and internal extension. If necessary you may disconnect either one of the parties by pressing the **DROP** button.

## RETRIEVING CALLS HELD AT ANOTHER STATION

When a line is on hold and it appears on your keyset, press the line button with the red flashing light.

When a line is on hold and it does not appear on your keyset, dial **12** plus the line number or the extension number of the station that placed the call on hold.

NOTE: If the Hot Keypad feature has been turned off, you must first lift the handset or press the **SPK** key before you begin dialing.

## TRANSFERRING CALLS

Transfer is used to send any call to another extension in one of two ways. You can do a screened transfer by informing the other extension who is calling or you can do a blind transfer without notification.

- While on a call, press the **TRSF** key and dial an extension number or group number. Your call is automatically put on transfer hold.

**OR**

Press a **DSS** key or station group key. Your call is automatically put on transfer hold.

- Hang up when you hear ringing (this is an unscreened or blind transfer). **OR** Wait for the called party to answer and advise him/her of the call and hang up. If the transfer is refused, you will be reconnected to the outside line when the called station hangs up or you can press **TRSF** to return to the outside party. If you wish to send the call to another extension without waiting for the first station to hang up, simply press another **DSS** button.

**OR**

Press the **CALL** button or C.O. line key to return to the outside party and begin the transfer process again.

When you are transferring a call to a keyset set for Voice Announce or Auto Answer, the transferred call will always ring.

NOTES:

1. After the inside party answers, you may alternate back and forth between the parties by pressing the **TRSF** key.
2. If you receive No More Calls tone, that station has no key available to receive another call. Press **TRSF** to return to the other party.
3. You cannot transfer an Intercom call by pressing a DSS key. You must press the **TRSF** key and dial the destination extension number.

## TRANSFER WITH CAMP-ON

When you are transferring a call to another station and you receive a busy signal, you may camp the call on to this station. Simply hang up when you hear the busy signal. The called party will be alerted that a call is waiting for them.

NOTE: If you receive No More Calls tone, that station has no key available to receive another call. Press **TRSF** to return to the outside caller.

## TRANSFER TO VOICEMAIL

This feature is used to send a call directly to a voice mailbox. Your keyset must have a correctly programmed VT key to accomplish this. To transfer a call directly to a voice mailbox:

- While on a call, press the VT key and dial the mailbox number.
- Hang up when dialing is completed.

## CALL WAITING

If an outside call has been camped-on to your phone or another station has camped-on to you:

- Your keyset will ring and the call that is waiting for you (camped-on) will flash green.
- Press the flashing button to answer; your other call will go on hold automatically if your station has the Automatic Hold feature set. If not, you must press **HOLD** and then the flashing button.

**OR**

Finish the first call and hang up; the waiting call will ring.

- Lift the handset or press the **ANS/RLS** key to answer.

NOTE: Intercom calls will not go on Automatic Hold.

## CONFERENCE CALLS

You may conference up to five parties (you and four others) in any combination of outside lines and internal stations in any order.

- While engaged in a conversation, press the **CONF** key and receive conference tone.
- Make another call, either intercom or outside, press the **CONF** key and receive conference tone.
- Make another call or press the **CONF** key to join all parties.
- Repeat the last step until all parties are added.

NOTE: When attempting to add another party to the conference and you are not able to reach the desired person, hang up. Simply press the **CONF** key again to return to your previous conversation.

**To drop a party from your conference call:**

- Press **CONF** and dial the extension or line number that is to be dropped.
- Press **CONF** again to reestablish the conference.

NOTE: To leave the conference, hang up. Control is passed to the next internal station. If there are no internal stations and you wish to leave outside lines connected together in a trunk to trunk conference, press the **CONF** key plus the **CALL** button that the call appears on or follow the instructions to drop a party and use your extension number. When they hang up, the lines will release automatically. Press **CONF** to rejoin a trunk to trunk conference.

### CONFERENCE SPLITTING

If you are the controlling party of a conference and your keyset has the Auto Hold feature turned on ([see customizing your keyset](#)) and all of the outside lines involved in the conference appear as buttons on your keyset, you can split the conference into separate calls as follows:

- Press any one of the outside line buttons. That outside line will remain steady green to indicate you are still connected to it. All other outside lines in the conference will be placed on system hold at your keyset. All intercom callers in the conference will be disconnected. You may now speak with each caller privately and transfer them as usual or reestablish another conference.

## FORWARDING CALLS

You may forward your calls to another station, group of stations or an external telephone number. Program a destination for the type of forwarding you want as detailed below. If you have **FWD ALL**, **FWD BUSY** and **FWD NO ANSWER** keys, press one to turn that forward feature on. A steady red light reminds you what forward condition is activated.

You can clear all call forward conditions set at your station by lifting the handset and dialing **600**.

## FORWARD ALL CALLS

To forward all your calls under any condition:

- Dial **601** plus the destination you want the call to forward to.
- Receive confirmation tone and hang up.

### NOTES:

1. If the Hot Keypad feature has been turned off, you must first lift the handset or press **SPK** before you begin dialing.
2. The station that receives a Forwarded All call can transfer the call to the forwarded station. This is useful when you are expecting an important call but you do not wish to be disturbed by other calls.

3. When a station user places his/her keyset in Forward All mode and he/she does not have a **FORWARD ALL** key, the **TRSF** key will light to indicate Forward All has been set and calls to this station have been transferred elsewhere.

## FORWARD BUSY

To forward calls when you are on the phone:

- Dial **602** plus the destination you want the call to forward to.
- Receive confirmation tone and hang up.

NOTE: If the Hot Keypad feature has been turned off, you must first lift the handset or press **SPK** before you begin dialing.

## FORWARD NO ANSWER

To forward calls when you do not answer:

- Dial **603** plus the destination you want the call forward to.
- Receive confirmation tone and hang up.

NOTE: If the Hot Keypad feature has been turned off, you must first lift the handset or press **SPK** before you begin dialing.

## FORWARD BUSY/NO ANSWER

If you have both a Forward on Busy destination and a Forward No Answer destination programmed, you may set both of these at the same time:

- Dial **604**.
- Receive confirmation tone and hang up.

NOTE: If the Hot Keypad feature has been turned off, you must first lift the handset or press **SPK** or the **MONITOR** key if you are using a 7B phone before you begin dialing.

## FORWARD FOLLOW ME

When you want all calls to your extension forwarded to the extension where you are now:

- Dial **606** plus your extension number.
- Receive confirmation tone and hang up.

If you want a specific extension's calls forwarded to your phone (Remote Call Forward):

- Dial **606** plus the desired extension number.
- Receive confirmation tone and hang up.

NOTE: If the Hot Keypad feature has been turned off, you must first lift the handset or press **SPK** before you begin dialing.

## FORWARD DND

To forward your phone when you activate DND.

- Dial **605** plus the destination you want the call to forward to.
- Receive confirmation tone and hang up.

NOTE: If the Hot Keypad feature has been turned off you must first lift the handset or press **SPK** before you begin dialing.

## CALL FORWARD OPTIONS

A display keyset may review or change call forward options and destinations. Call forward access can be done via the keypad or by accessing the keyset display features. To review or change call forward options:

- Press **TRSF 102**.  
The display will indicate the current call forward condition and destination  
**OR**  
Show **0: FORWARD CANCEL** to indicate no forward is set.
- Dial **0** to cancel current condition  
**OR**  
Dial **1-5** to select forward type  
**OR**  
Press **UP** or **DOWN** to select forward type.  
Press the right soft key to move the cursor.
- Dial the destination number (e.g., 202) **OR**  
Press **UP** or **DOWN** to select the destination.  
Press the right soft key to move the cursor.
- Dial **1** to set **OR**  
Press **UP** or **DOWN** to select **YES** or **NO**.
- Press **TRSF** to store and exit.

## STATION CALL PICKUP

To pick up (answer) a call ringing at another station, lift the handset and dial **65** plus the extension number of the ringing phone.

If you have a **DP** key assigned with a station number, you only need to press this **DP** key with the flashing light to answer this ringing station.

NOTE: If the Hot Keypad feature has been turned off, you must first lift the handset or press **SPK** or **MONITOR** before you begin dialing.

## GROUP CALL PICKUP

To pick up (answer) a call ringing in any pickup group, lift the handset and dial **66** plus the desired group number or press the flashing **GROUP PICKUP** key if available.

### GROUP NUMBERS

<b>01-10</b>	<b>OfficeServ 7030</b>
<b>01-20</b>	<b>OfficeServ 100, OfficeServ 7100, OfficeServ 7200-S</b>
<b>01-99</b>	<b>OfficeServ 500 M</b>
<b>01-99</b>	<b>OfficeServ 500 L</b>
<b>01-99</b>	<b>OfficeServ 7200 and OfficeServ 7400</b>

### NOTES:

1. A group pickup key can have an extender for a specific pickup group.
2. If the Hot Keypad feature has been turned off, you must first lift the handset or press **SPK** or the **MONITOR** key if you are using a 7B phone before dialing the access code.

## MY GROUP PICKUP

If desired, a new access code can be assigned to pickup ringing calls in the same pickup group as you are in. Like "66" above except you do not need to dial the desired group number. See your installation company for the assigned access code. MY GROUP PICKUP: \_\_\_\_\_.

## PRIVACY RELEASE

This feature will allow another station to join in on your conversation by releasing privacy on the C.O. from your phone.

**To Release Privacy:** While on you are talking on a C.O. line and you wish to have other internal parties (or up to three) join the conversation:

- Press the **PRB** key (the **PRB** key will light steady red). Inform the other party that he/she may now join the conversation.

After the other party (or parties) has joined the conversation and you wish to return privacy to the line so that no one else can join the conversation, press the **PRB** key a second time, the **PRB** key LED will be off.

**To Join a Non-Private Conversation:** When someone has informed you that you can join a conversation:

- Press the C.O. line key that he/she has indicated.  
OR
- Dial the C.O. line number that he/she has indicated.

## DIALING FEATURES

### SPEED DIALING

You can dial a preprogrammed telephone number stored in the system-wide speed dial list of numbers 500–999 or from your personal list of numbers 00–49.

Your system may be set for 950 system wide numbers. If so the system speed dial access codes are 050~999 and the station speed dial codes are 000~049.

- With the handset on-hook, press the **SPD** key or dial **16**.
- Dial the desired speed dial number.
- The telephone number is automatically dialed for you.

NOTE: If the Hot Keypad feature has been turned off, you must first lift the handset or press **SPK** or **MONITOR** before you begin dialing.

### PROGRAMMING PERSONAL SPEED DIAL NUMBERS

You can program frequently dialed telephone numbers in a personal speed dial list. A station may be assigned up to fifty numbers, **00–49**. See your system administrator to determine the amount assigned to your station.

- While on-hook, press **TRSF** and then dial **105**.
- Dial a speed dial number (**00–49**).
- Dial a line or line group access code.
- Dial the telephone number to be stored (24 digits maximum). It can include #, \*, FLASH and PAUSE.
- Press **TRSF** to store the number.

NOTE: If the Hot Keypad feature has been turned off, you must first lift the handset or press **SPK** or the **MONITOR** key if you are using a 7B phone before you begin dialing.



**12 BUTTON KEYS  
PROGRAMMABLE KEYS LAYOUT**

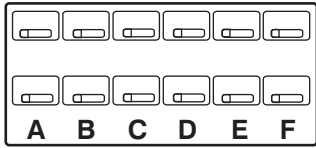

**24 BUTTON KEYS  
PROGRAMMABLE KEYS LAYOUT**

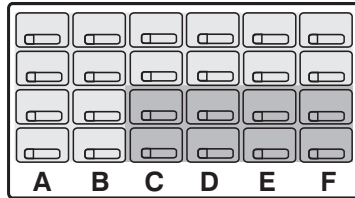

For the purposes of programming speed dial numbers, the programmable keys in the bottom row are known as **A**, **B**, **C**, **D**, **E** and **F** and are defined below.

- The **A** key is not used.
- The **B** key inserts a flash.
- The **C** key inserts a pause.
- The **D** key is used for pulse to tone conversion. If your system uses rotary (or pulse) dialing C.O. lines, pressing **D** while entering a speed dial number causes all subsequent digits to be sent as DTMF tones.
- The **E** key is used to hide digits. Display keyset users may want to hide some speed dial numbers so that they will not show in the display. When you are entering a telephone number, press **E**. All subsequent digits will be hidden. Press **E** again to begin displaying digits.
- The **F** key is used to enter a name. [See Personal Speed Dial Names under Display Features.](#)
- Use the **HOLD** key to clear a speed dial number.

## ONE TOUCH SPEED DIALING

You may assign any speed dial number to an already existing One Touch Speed Dial button for quick and easy dialing of frequently used numbers.

- While on-hook, press **TRSF** and then dial **107**.
- Press a One Touch Speed Dial button.
- Dial the speed dial number (**00–49** or **500–999**) that you want assigned to this button.
- Press **TRSF** to store your selection.

To call this telephone number, just press the One Touch Speed Dial button.

NOTE: If the Hot Keypad feature has been turned off, you must first lift the handset or press **SPK** or the **MONITOR** key if you are using a 7B phone before you begin dialing.

## LAST NUMBER REDIAL

To redial the last telephone number you dialed, press the **LNR** key or dial **19**.

NOTES:

1. If the Hot Keypad feature has been turned off, you must first lift the handset or press **SPK** or **MONITOR** before you begin dialing.
2. Redial does not apply to intercom calls.

## MANUAL RETRY WITH LNR

While you are on an outside call listening to a busy signal and you want to redial the same number dialed.

- Press the **LNR** key.

This will hang up your existing call and manually redial the same number dialed. You can repeat this operation for a limited number of attempts.

## SAVE NUMBER WITH REDIAL

To save the number you just dialed for later use, press the **SNR** key before hanging up.

To redial this saved number at any time, press the **SNR** key or dial **17**. The same line will be selected for you.

NOTES:

1. If the Hot Keypad feature has been turned off, you must first lift the handset or press **SPK** or the **MONITOR** key if you are using a 7B phone before you begin dialing.
2. The saved telephone number is stored in memory until you save another.
3. Redial does not apply to intercom calls.

## CHAIN DIALING

You may manually dial additional digits following a speed dial number or chain as many speed dial numbers together as required:

- After the first speed number is dialed, press **SPD** again and dial another speed number **OR** manually dial additional digits following a speed dial number.

## AUTOMATIC REDIAL/RETRY

When you are making an outside call and you receive a busy signal, the system can automatically redial the number for you. It will automatically redial at a pre-programmed interval for up to 15 attempts.

- When you hear a busy signal, press the **RETRY** button.
- The system will reserve the line and automatically redial the same number for you. You will hear the call being made through the keyset speaker. The microphone is muted.
- When the called party answers, lift the handset or press the flashing **SPK** to begin speaking.

### NOTES:

1. If you make another call, auto-redial is canceled.
2. To cancel a retry, lift and replace the handset.

## PULSE TO TONE CHANGEOVER

When making an outside call on a dial pulse line, press **#**. All digits dialed after the **#** will be sent as tones.

## MEMO REDIALING

When you are calling directory information, you can store the number you are given using the **SAVE** feature. There is no need for pencil and paper.

- While you are talking on an outside call, press **SAVE**.
- Dial the telephone number as it is dictated to you on the key pad.
- Press **SAVE** to store the number.

To dial the number, press the **SNR** button. It will select the same line and dial the stored number. If necessary, you can select a different line and then press the **SNR** button.

# PAGING AND MESSAGING

## MAKING AN INTERNAL PAGE

To make an announcement through the keyset speakers in the idle condition:

- Lift the handset.
- Press the **PAGE** key or dial **55**.
- Dial the desired zone number **0, 1, 2, 3** or **4**.
- After the attention tone, make your announcement.

### NOTES:

1. If you have a dedicated page zone button, it is not necessary to press **PAGE** and dial a zone number.
2. If allowed by your system administrator you may be able to initiate a page from a speakerphone by pressing the **PAGE** key or dialing **55** without lifting the handset.

## MAKING AN EXTERNAL PAGE

To make an announcement through the external paging speakers:

- Lift the handset.
- Press the **PAGE** key or dial **55**.
- Dial the desired zone number **5, 6, 7** or **8 OR** Dial **9** to page all external zones.
- After the attention tone, make your announcement.

### NOTES

1. If you have a dedicated page zone button, it is not necessary to press **PAGE** and dial a zone number.
2. If allowed by your system administrator you may be able to initiate a page from a speakerphone by pressing the **PAGE** key or dialing **55** without lifting the handset.

## ALL PAGE

To page all designated keysets in internal zone 0 and all external zones at the same time:

- Lift the handset.
- Press the **PAGE** key or dial **55**.
- Dial **\*** or press the **ALL PAGE** key.

- After the attention tone, make your announcement.

#### NOTES

1. The LED on the **PAGE** button will only light when an All Page is in progress.
2. If allowed by your system administrator you may be able to initiate a page from a speakerphone by pressing the **PAGE** key or dialing **55** without lifting the handset.

## MEET ME PAGE

- Lift the handset.
- Press the Meet Me Page (**MMPG**) key or dial **54**.
- Dial the desired zone number.
- After the attention tone, instruct the paged person to dial **56**.
- Press **WAIT** or **TRSF**.
- Remain off-hook until the person dials **56** from any phone.
- The paged person will be automatically connected with you.

## CALL PARK AND PAGE

When you have an outside call for someone who is not at his/her desk, you can park the call prior to paging. The OfficeServ 100, the OfficeServ 500, and OfficeServ 7000 Series systems offer two different methods:

#### MANUAL PARK ORBITS

- While in conversation, press the **PARK** button.
- Enter a desired orbit number (**0-9**), if the orbit number is busy dial another orbit number. Display users can press **\*** to automatically place the call in any available orbit number and see the number in the display.
- Remember the selected orbit number and replace the handset when finished.
- Lift the handset and make a page announcement as previously described (example: "John Smith park two").

#### To retrieve a parked call from orbit:

- Press the **PARK** button and dial the announced orbit number (**0-9**).
- You will be connected to the parked call.

#### NOTES:

1. You must have a **PARK** button or park access code to retrieve and place calls in park orbits.
2. If the call is not retrieved within a pre-programmed period of time, it will recall your keyset and have a slow amber light. You cannot park and page intercom calls.
3. If the Hot Keypad feature has been turned off, you must first lift the handset or press **SPK** before you begin dialing.

#### AUTOMATIC PARK WITH PAGE KEY

- While in conversation, press the **PAGE** button. The call is automatically parked at your station.
- Receive page tone and dial a desired page zone number.
- Make announcement indicating your extension number or the line number. Hang up.

#### To retrieve an automatically parked call:

- Dial **10** plus the number that was announced. If you have a **PAGPK** key, press it and dial the number that was announced. If you have a **PARK** key, press it and dial the announced orbit number.
- You will be connected to the parked call.

#### NOTES:

1. If the call is not retrieved within a pre-programmed period of time, it will recall your keyset and have a slow amber light. You cannot park and page intercom calls.
2. If the Hot Keypad feature has been turned off, you must first lift the handset or press **SPK** before you begin dialing.

## SETTING A MESSAGE INDICATION

When you are calling another station and no one answers or you receive a busy signal, you can leave a message indication:

- Press the **MSG** key or dial **43** and receive confirmation tone.
- Hang up. The **MSG** key on the called station will light. Standard telephones receive special dial tone as a message indication or a lit message lamp, if the phone is equipped with one and they are connected to a 16MWSLI card on the system.

#### NOTES:

1. A station can have up to five message indications.
2. If the Hot Keypad feature has been turned off, you must first lift the handset or press **SPK** before you begin dialing.

## CANCELING MESSAGES

To cancel a message indication that you left at another station, dial **42** plus the extension number of the station at which you left a message.

To cancel all message indications left at your keyset, dial **42** plus your extension. Your **MSG** light will go out.

NOTE: If the Hot Keypad feature has been turned off, you must first lift the handset or press **SPK** before you begin dialing.

## RETURNING MESSAGES

- Press the **MSG** key or dial **43**. The first station that left a message will be called automatically. If that station does not answer, your **MSG** light will stay on.
- Repeat until all messages have been returned in the order received.
- Your **MSG** light will turn off when all messages have been returned.

NOTES:

1. Display keyset users can view message indications and return them in any order. [See Viewing Message Indications under Display Features.](#)
2. If the Hot Keypad feature has been turned off, you must first lift the handset or press **SPK** or the **MONITOR** key if you are using a 7B phone before you begin dialing.
3. If a message has been left at your keyset by a keyset in Auto Answer, you must manually cancel the message after it has been returned.

## PROGRAMMED MESSAGES

When you will be away from your phone for any length of time, you can leave a programmed station message. Display stations calling you will see this message and be informed of your status or follow your instructions.

- Dial **48** plus any message code (**01-20**) listed on the back of this user guide.
- To cancel any of these messages you might have selected, dial **48** plus **00**.
- Press **TRSF** to exit and store your selection.

NOTE: If the Hot Keypad feature has been turned off, you must first lift the handset or press **SPK** before you begin dialing.

You can have multiple programmed message keys (**PMSG**) and each one can have a different message code:

- Press any programmed message (**PMSG**) button. The message is set and the button will light red. Press the button again to turn off.
- Pressing another programmed message (**PMSG**) button will turn the previous one off and set a different programmed message.

## CONVENIENCE FEATURES

### DO NOT DISTURB

Use this feature when you want to block calls to your keyset.

- While on-hook, press the **DND** key or dial **401**. The **DND** key lights steady red to remind you of this mode.
- To cancel DND, press the **DND** key again or dial **400**. The **DND** light turns off. You can make calls while in the DND mode.

NOTES:

1. If the Hot Keypad feature has been turned off, you must first lift the handset or press **SPK** or the **MONITOR** key.
2. If you place your keyset in DND mode and you do not have a **DND** key, your **ANS/RLS** key will flash to indicate DND status.

### ONE TIME DND

If you are on a call and you do not wish to be interrupted while on that call, you can press the **DND** key and place your station in Do Not Disturb. When you hang up at the end of the call, DND will be automatically canceled and your keyset will be able to receive new calls. This feature requires a **DND** key.

NOTE: This feature will not affect any calls currently ringing your keyset.

### MUTE

You can mute the handset transmitter or the microphone during any conversation:

- Press the **MUTE** key. It will light red.
- To resume speaking, press the **MUTE** button again. The light turns off.

### BACKGROUND MUSIC

When a music source is supplied, you may listen to music through the speaker in your keyset:

- While on-hook, press the **HOLD** button to hear music.
- Press the **HOLD** button again to turn music off.

You can set the level of background music by using the **VOL** keys while listening to the music. This does not affect the speakerphone level.

## ESTABLISHED CALL PICKUP

To pick up an established call in progress at a single line extension connected to a computer modem on your PC.

- Press the **EP** key for that station on your keyset and the call is automatically moved to your keyset.
- The single line extension on your modem will be disconnected.

NOTE: You must have an assigned (EP key) button on your regular keyset, for the single line station.

## APPOINTMENT REMINDER/ALARM CLOCK

This feature works like an alarm clock. Use it to remind yourself of an appointment later in the day (TODAY ONLY) or as a daily reminder every day (DAILY). You can set up to three alarms. Each one can be either a TODAY ONLY or a DAILY alarm.

When the alarm rings, you will hear three short rings repeated three times. Lift the handset to answer the alarm. If you do not, the alarm will alert you two more times at five minute intervals.

To set alarms:

- Press **TRSF** and then dial **112**.
- Dial the alarm number **1, 2** or **3**.
- Dial the time at which you want the alarm to sound. Enter the time as HHMM (hours and minutes) using the 24 hour clock.
- Dial **0** (NOT SET), **1** (TODAY ONLY) or **2** (DAILY) to select the alarm type.
- Press **TRSF** to save.
- Repeat for each alarm if needed.

To cancel individual alarms:

- Press **TRSF** and then dial **112**.
- Dial alarm number **1, 2** or **3**.
- Press the **HOLD** key.

NOTE: Display keysets can show a reminder message. [See Alarm Reminder Messages under Display Features.](#)

## ANSWERING THE DOOR PHONE

When you are programmed to receive calls from a door phone:

- You will receive three short rings repeated.
- Lift the handset or press **ANS/RLS** or the **MONITOR** key. You are connected to the door phone.
- If an electric door lock release is installed, dial **13** to unlock the door.

## CALLING THE DOOR PHONE/ROOM MONITOR

You may call the door phone and listen to what may be happening outside or in another room.

- Dial the extension number of the door phone.
- You will be connected to the door phone and you can listen or have a conversation.
- If an electric door lock release is installed, dial **13** to unlock the door.

NOTE: If the Hot Keypad feature has been turned off, you must first lift the handset or press **SPK** or the **MONITOR** key.

## EXECUTIVE/SECRETARY HOT LINE

If programmed, an executive and a secretary can have a hot line between them. When the executive station is in the DND mode, all of its calls will ring the secretary station. If the secretary does not answer, the caller will go to the secretary's voicemail box if setup.

- Either person can press the **BOSS** key to make a voice call to the other station.
- Using the hot line will override DND at the other station. This key will light red when the other station is in use.

To transfer a call to a Boss in DND:

- Press the **TRSF** key followed by the **BOSS** key.
- Wait for the **BOSS** station to answer, then announce the call and hang up to complete the transfer **OR**
- Hang up to complete a blind transfer after pressing the **BOSS** key.

## GROUP LISTENING

When you are engaged on a call and you are using the handset, you may want other people to hear the distant party's voice over the speaker:

- Press the **LISTEN** key to turn on the speaker. The microphone is not in use, so the distant party does not hear other parties present in your office.
- Press **LISTEN** again to turn the speaker off and resume private conversation.
- Repeat if necessary.

NOTE: Depending on speaker volume and the acoustics of your office, it may be advisable to turn the group listening feature off before hanging up. This will eliminate a momentary squeal.

## ACCOUNT CODES

When enabled, your system allows calls to be charged to different accounts. You can enter account codes either by dialing the full code, by entering an account code "bin number", or by pressing your **ACC** key if one is assigned. Bin numbers are a 3 digit short code that will automatically insert the appropriate account code. Account codes may be a maximum of 12 digits (# may be used); if the account code is to be less than 12 characters you may end the code by pressing \* or the right soft key. The type of code used is determined by your telephone system administrator. Codes can be entered before or during a call as follows:

To enter an account code before placing the call:

- Press your **ACC** key or dial **47**.
- Dial the account code or bin number.
- You will receive a confirmation tone and display.
- When prompted dial a trunk or trunk group (i.e. 9) and the telephone number to call.

To enter an account code by interrupting the conversation:

- While on an outside call press the **ACC** key or press TRANSFER followed by **47**.
- Dial the account number or bin number (if you are entering an account code you will need to press your **ACC** key or right soft key to finalize the entry)

NOTE: If you make an error simply repeat the procedure with the correct code. Only the most recent account code dialed will be recorded.

## LOCKING YOUR KEYSSET

You can lock your keyset to control misuse of your phone while you are away. You can unlock it when you return. Your default station passcode is 1234.

	0 UNLOCKED	1 LOCKED OUTGOING Hold Button LED Flashes	2 LOCKED ALL CALLS Hold Button LED Solid
Make outside calls	YES	NO ACCESS DENIED	NO
Receive outside calls	YES	YES	NO
Make intercom calls	YES	YES	NO
Receive intercom calls	YES	YES	NO
Make 911 calls	YES	YES*	NO

- While on-hook, press **TRSF** and then dial **100**.
- Dial your four digit station passcode.
- Dial **1** for locking outgoing, **2** for locked all calls or **0** to unlock.
- Press **TRSF** to store your selection.

NOTE: When your keyset is locked for outgoing, the **HOLD** key will flash. When your keyset is locked for all calls, the **HOLD** key will light steady.

## MANUAL SIGNALLING

Use this feature when you want to send a brief 500ms ring burst to another station, regardless of the status of your phone (on-hook, off-hook, handsfree, DND or ringing).

To send a signal to another station:

- Press the Manual Signalling (**MS**) key.
- You may press the **MS** key repeatedly to send multiple signals to the designated station.

NOTE: Your phone must have a Manual Signalling (**MS**) key with a station number extender assigned to it.

## OFF-HOOK VOICE ANNOUNCE

Keysets may receive a voice announcement while on another call. The calling station must have an **OHVA** key. When you are in DND, you cannot receive OHVA calls. The OHVA feature will work with intercom calls and transferred calls.

To make an off-hook voice announcement:

- Dial the extension number or press the **DSS** key.
- When you receive a busy signal, press the **OHVA** key.
- After the attention tone, begin speaking.
- Finish the call by replacing the handset or pressing the **ANS/RLS** or the **MONITOR** key if you are using a 7B phone.

NOTES:

1. When you are voice announcing to a station close to you, use the handset to avoid an echo effect.
2. You cannot off-hook voice announce to single line telephones.

If your keyset is associated with a DCS 32 Button Add-On Module (DCS 32 AOM is not supported on the OfficeServ 7100, OfficeServ 7030), you can receive Executive OHVA calls. Executive Off-Hook Voice Announce allows you to engage in conversation on your keyset and simultaneously receive and reply handsfree to an OHVA through your DCS 32 Button Add-On Module (AOM). Use caution because the conversation through the AOM may possibly be heard by the caller on the keyset.

When you receive an off-hook voice announcement, if you are using the handset, you will hear the announcement over the handset receiver. If you are using the speakerphone, you will hear the announcement over the keyset speaker. In both cases, you can continue to speak to the original party.

- Press the flashing **CALL** button on your keyset. This will place the original party on hold and allow you to talk to the announcing party.
- To return to your first party, press the key corresponding to your original call. This will disconnect the OHVA call.

Executive off-hook voice announce allows you to engage in conversation on your keyset and simultaneously receive and reply handsfree to an OHVA through your add-on module (AOM). Use caution because the conversation through the AOM may possibly be heard by the caller on the keyset. When you receive an executive OHVA through your AOM:

- Reply by speaking in the direction of the microphone in the AOM unit.
- Adjust the volume with the **VOL** keys on the AOM unit.

- Press the **SPK** or the **MONITOR** key on the AOM to disconnect the announcing party.

NOTES:

1. Executive off-hook voice announce can only be accomplished when an AOM is attached to your phone.
2. If the **MUTE** key on the AOM is lit, you must press the AOM's **SPK** key to answer the OHVA call.

## OHVA BLOCK

Your keyset can be programmed with an OHVA Block (**BLOCK**) key. Pressing this key will prevent anyone from making an OHVA to you until you press the button again and cancel the blocking.

## OHVA REJECT

Your keyset can be programmed with an OHVA Reject (**REJECT**) key. Pressing this key while receiving an OHVA call will disconnect the voice announcing party and return you to your original call.

## IN GROUP/OUT OF GROUP

If your keyset is assigned to a station ring group, you can remove your keyset from the group and then put it back in. While you are out of the group, you can receive calls to your extension number but not calls to the group number. If you have an **IN/OUT** key with the group number assigned.

- Press the **IN/OUT** key. It will light red when your keyset is in the group.
- Press the **IN/OUT** key again to exit the group and turn the light off. Repeat as necessary.

If you do not have an **IN/OUT** key:

- Dial the **IN/OUT** access code number \_\_\_\_\_, then the group number, then **0** to exit the group or **1** to enter the group.

NOTE: If the Hot Keypad feature has been turned off, you must first lift the handset or press **SPK** or the **MONITOR** key.

The **IN/OUT** key can include an extender to indicate the specific group that this key will affect. This means that if you are in multiple groups, you can decide for which groups you will receive calls.

# CUSTOMIZING YOUR KEYSSET

## AME PASSWORD

This feature allows people using the AME feature to enable password protection. This will prevent unauthorized people from listening to your messages being left. The passcode is the same as your station passcode. This feature only applies if there is an SVM card installed in the system and your keyset has a programmed AME key.

- With the handset on-hook, press **TRSF** and then dial **110**.
- Dial **101** to turn on AME PASSWORD or **100** to turn it off.
- Press **TRSF** to store your selection.

## AUTO CAMP-ON

This option allows intercom calls to be automatically camped on, if possible, when a busy station is called.

- With the handset on-hook, press **TRSF** and then dial **110**.
- Press **081** to turn CAMP-ON on or **080** to turn it off.
- Press **TRSF** to store your selection.

## SELECT RING TONE

Each keyset user can select any one of eight ring frequencies:

- While on-hook, press **TRSF** and then dial **111**.
- Dial **1–8** or press the **UP** and **DOWN** keys to hear each tone.
- When you hear the tone that you prefer, press **TRSF** to save it.

NOTE: Specific lines or stations may be programmed to ring with a different tone than what you have selected for you keyset.

## CHANGE YOUR PASSCODE

From the factory, your station passcode is 1234. You can change your station passcode whenever you desire.

- While on-hook, press **TRSF** and then dial **101**.
- Dial your old passcode.
- Dial a new passcode (must be four characters). You can use **0–9**.
- Redial the new passcode to verify. If successful, you will hear two beeps. Four beeps indicate an incorrect code. Reenter the code again.
- Press **TRSF** to store the new passcode.

## SET ANSWER MODE (INTERCOM)

You can receive internal calls in one of three modes ([see Answering Intercom Calls under Intercom Calls for descriptions](#)):

- While on-hook, press **TRSF** and then dial **103**.
- Dial **0** for Ringing, **1** for Auto Answer or **2** for Voice Announce.
- Press **TRSF** to store your selection.

NOTE: When your keyset is programmed for Auto Answer and you have Forward No Answer (FNA) turned on, you must answer screened transfers by pressing **ANS/RLS** or the **MONITOR** key if you are using a 7B phone before your FNA timer expires or the call will forward.

## SET ANSWER MODE (CO)

Your incoming CO calls can be set to follow the intercom answer mode.

- While on-hook, press **TRSF** and then dial **110**.
- Dial **15** to access **AUTO ANS CO**.
- Press the **VOLUME UP** or **DOWN** key to change the status.
- Press **TRSF** to store your selection.

## AUTOMATIC HOLD

While on an outside call, pressing a line key, route key or a flashing **CALL** button will automatically put your call on hold and connect you to the next call. This feature can be turned on or off at your keyset.

- With the handset on-hook, press **TRSF** and then dial **110**.
- Dial **001** to turn Automatic Hold on or **000** to turn it off.
- Press **TRSF** to store your selection.

NOTE: Intercom calls can only be automatically put on hold by pressing **TRSF**.

## HEADSET OPERATION

Keyset users can switch between headset mode and handset mode. When using headset mode, press the **ANS/RLS** or the **MONITOR** key if you are using a 7B phone to answer and release calls.

- With the handset on-hook, press **TRSF** and then dial **110**.
- Dial **021** to use the headset or **020** to use the handset.
- Press **TRSF** to store your selection.



Your keyset may be equipped with a Headset mode key. If it is so equipped pressing this key while the light is out will cause the keyset to enter headset mode and the light will illuminate to indicate this. Pressing the key while the light is lit will cause the keyset to return to handset mode and the light will go out.

## HOT KEYPAD

Your keyset's keypad can be made "live" or "hot" so that it is not necessary to lift the handset or press **SPK** or the **MONITOR** key before you begin dialing. Calls can be made and features activated by simply dialing the C.O. line number, trunk group access code, intercom number or feature access code. To activate this feature:

- With the handset on-hook, press **TRSF** and then dial **110**.
- Dial **031** to turn the Hot Keypad on or **030** to turn it off.
- Press **TRSF** to store your selection.

## KEY CONFIRMATION TONE

You can hear a short beep (confirmation tone) each time you press a button on the dial pad. This tone can be turned on or off.

- While on-hook, press **TRSF** and then dial **110**.
- Dial **040** to turn tones off or **041** to turn tones on.
- Press **TRSF** to store your selection.

## REJOINING A PAGE

This feature allows you to hear the remaining portion of an ongoing internal page after you return your keyset to idle. To enable this feature:

- With the handset on-hook, press **TRSF** and then dial **110**.
- Dial **051** to turn this feature on or **050** to turn it off.
- Press **TRSF** to store your selection.

## RING PREFERENCE

This feature automatically answers ringing calls when you lift the handset or press the **ANS/RLS** or the **MONITOR** key if you are using a 7B phone. This method will always answer calls in the order they arrived at your keyset. When you turn ring preference off, you must press the flashing button to answer a call, allowing you to answer calls in the order you choose.

- With the handset on-hook, press **TRSF** and then dial **110**.
- Dial **061** to turn ring preference on or **060** to turn it off.
- Press **TRSF** to store your selection.

## DISPLAY SPEED DIAL NAME

This option allows you to view the name associated with a speed dial number as it is dialed.

- With you handset on-hook, press **TRANSFER** and then dial **110**.
- Press **111** to turn **DISP SPDNAME** on or **110** to turn it off.
- Press **TRANSFER** to store your selection.

## CALLER ID REVIEW ALL

This feature allows display keyset users to review Caller ID information for calls sent to their stations. This list can be from ten to fifty calls in a first in, first out basis. The list includes calls that you answered and calls that rang your station but that you did not answer. When reviewing this list, you can press one button to dial the person back. The system must be using LCR to dial the stored number.

- With you handset on-hook, press **TRANSFER** and then dial **110**.
- Press **121** to turn **CID REVIEW ALL** on or **120** to turn it off.
- Press **TRANSFER** to store your selection.

## SECURE OHVA

This option allows you to receive OHVA calls via the speaker while you are on the handset.

- With you handset on-hook, press **TRANSFER** and then dial **110**.
- Press **131** to turn **AUTO CAMP-ON** on or **130** to turn it off.
- Press **TRANSFER** to store your selection.

## CONFIGURE MOBILE EXTENSIONS (MOBEX)

This feature allows you to configure options for any Mobile Extension (MOBEX) ports that are assigned to you by your telephone system administrator. You can turn a port on or off; set the telephone number for the port; or set the caller ID you will be calling in from. The caller ID field has no effect unless you have been authorized as an Executive MOBEX user. Check with your telephone system administrator for further details on your specific system configuration.

To set the phone number a MOBEX port can reach you on:

- Press **TRANSFER** and then dial **126**.
- Dial your station pass code.
- Dial the number of the port you wish to configure (1-5) (you may also use the Volume Up and Volume Down keys to select a port and press the right soft key to confirm).
- Dial **0** to select the telephone option.

- Dial the number of a C.O. line to use when making calls to this MOBEX port.
- Dial the phone number you can be reached at by users calling this MOBEX port.
- Press **TRANSFER** to store your selection and exit programming.

To set the caller ID of the location you will be calling in from:

- Press **TRANSFER** and then dial **126**.
- Dial your station pass code.
- Dial the number of the port you wish to configure (1-5) (you may also use the Volume Up and Volume Down keys to select a port and press the right soft key to confirm).
- Dial **1** to select the caller ID option.
- Dial the phone number you will be calling in from.
- Press **TRANSFER** to store your selection and exit programming.

To turn a MOBEX port ON or OFF:

- Press **TRANSFER** and then dial **126**.
- Dial your station pass code.
- Dial the number of the port you wish to configure (1-5) (you may also use the Volume Up and Volume Down keys to select a port and press the right soft key to confirm).
- Dial **2** to select the activation status option.
- Dial **0** to turn the port on, dial **1** to turn the port off.
- Press **TRANSFER** to store your selection and exit programming.

## DISPLAY FEATURES

### INTERACTIVE DISPLAY KEYS

The three keys below the display are substitutes for dedicated feature keys and access codes. Pressing one of these keys has the same effect as pressing a programmable key. These keys are called soft keys as their functions are not fixed. They change to present you with the best options for that call condition. The use of soft keys allows the programmable keys to be used for more **DSS** and speed dial keys.

The **SCROLL** key is used to display options available to the user at a particular time or during a specific procedure. Press this key once while in the idle state to view the three main categories available.

201: STN NAME  
CALL OTHER ANS

**ANSWER:** Guides you through the options to answer calls.

**OTHER:** Guides you through features other than making or answering calls.

**CALL:** Guides you through the options to make a call.

Select one of the main categories: **CALL**, **OTHER** or **ANS (ANSWER)**. Press the **SCROLL** key to display additional options available under each of the three main categories. The symbol ➡ displayed as the last character on the lower line of the display indicates that there are additional options. Press the **SCROLL** key to display these additional options.

User instructions will be displayed in lower case letters. Options assigned to soft keys will be in upper case letters.

### DIRECTORY INFORMATION

An 11 character directory name can be assigned to each extension number. Display keyset users can view the name of the called or calling station before answering.

Each outside line can have an 11 character directory name. Incoming calls can be easily identified and answered with different greetings.

Outside and internal calls ringing to a station group will display [CALL FOR xxx] where xxx is the station group number. This allows you to answer calls directed to you differently than calls directed to your group.

## CALL LOG

The system can log both incoming and outgoing calls placed from or to your telephone. You must have a LOG button programmed on your keyset and assigned a review list. Each IN and OUT list can be up to 50 numbers maximum. They are assigned in blocks of 10 each.

To view your incoming and outbound call logs:

- Press the **LOG** key.
- Press either the **IN** or **OUT** key.
- View the first IN/OUT telephone number. At this point you may select one of the three options related to this number or use the **UP/DOWN** keys to scroll through your list of calls.
- Press the **CLEAR** key to erase this number from the list.
- Press the **NND** key repeated to view the Name, Number, or Date associated with this call.
- Press the **DIAL** key to call this number.

These options are the same for the incoming or outgoing call logs.

## DIAL BY NAME

Each station or speed dial number can have an associated directory name. A station or speed dial number can be selected by scrolling alphabetically through a directory name list. This on-line "phone book" allows the user to look up and dial any station or speed dial number in seconds.

- Press the **DIR** key (**DIRECTORY**).
- Select the directory you wish to use: **PERS** (personal speed dial numbers), **SYS** (system speed dial numbers) or **STN** (station names).
- Dial the key on the keypad that corresponds to the first letter of the name you wish to search for.
- Use the **UP** and **DOWN** arrows to scroll through the names.
- Press the **DIAL** soft key to dial the number.

NOTE: A **DIR** key can have an extender to take you directly to one of the above lists, (PERS, SYS, or STN).

## CALL PROGRESS DISPLAYS

During everyday call handling, your keyset display will provide information that is helpful and in some cases invaluable. Displays like [CALL FROM 203], [TRANSFER TO 202], [701: RINGING], [TRANSFER FM 203], [708 busy], [Camp on to 204], [Recall from 204], [Call for 501], [message from 204] and [FWD ALL to 204] keep you in-

formed of what is happening and where you are. In some conditions you are prompted to take an action and in other cases you receive directory information.

## DISPLAY NUMBER DIALED

Display keysets begin showing digits as they are dialed. They will stay in the display until the call duration timer comes on automatically or the **TIMER** button is pressed. If the call duration timer is not used, the number dialed will be displayed until the call is released, transferred or put on hold.

## CALL DURATION TIMER

The system can be set to automatically time outside calls. A few seconds after you dial a telephone number, the timer appears in the display. It appears immediately for incoming calls. The call timer continues for the duration of the call. Call duration times are displayed in minutes and seconds. If a call lasts longer than 60 minutes, the timer restarts.

You can press the **TIMER** key to manually begin timing a call. Press it again to stop timing. If you press it while the automatic timer is on, the call duration time is restarted.

## AUTO TIMER

Display keyset users may have the timer automatically start when they answer incoming calls or after a short delay on an outgoing call.

- With the handset on-hook, press **TRSF** and then dial **119**.
- Dial **41** to turn the auto timer on or **40** to turn it off.
- Press **TRSF** to store your selection.

## TIMER FUNCTION

Display keyset users may use this feature as a simple stopwatch.

- When the keyset is idle, press the **TIMER** button to start timing.
- Press the **TIMER** button again to stop timing.
- Read the elapsed time in the display.
- Lift the handset and replace it. The display will return to date and time.

## VIEWING MESSAGE INDICATIONS

You can view all of your message indications before you return them:

- With the handset on-hook, press the **MSG** key with the red flashing light.
- The first station that left a message indication will be displayed.
- Press the **UP** and **DOWN** arrows to scroll through the stations that left message indications. Use the soft keys to reply, clear or advance to the next message.
- Press the **ANS/RLS** key to return your keyset to the idle condition.

## ALARM REMINDER MESSAGES

When you use the alarm/appointment reminder feature, you create a 16 character reminder message. When the alarm rings, your message will appear instead of [ALARM REMINDER]. To program reminder messages:

- Press **TRSF** and then dial **116**.
- Dial the alarm number **1, 2** or **3**.
- Dial the time you want the alarm to go off. Enter the time as HHMM (hours and minutes) using the 24 hour clock.
- Dial **0** (NOT SET), **1** (TODAY) or **2** (DAILY) to select the alarm type.
- Write your message using the dial pad keys. Each press of a key selects a character. Pressing the next key moves the cursor to the next position. For example, if your message is "TAKE MEDICATION," press **8** once to get the letter "T." Press **2** once to get "A." Press **5** twice to get "K." Continue selecting characters from the following table to complete your message.
- Press the **TRSF** key to store the alarm and reminder message.
- Repeat for each alarm if needed.

COUNT	1	2	3	4	5
DIAL 0	Q	Z	.	)	0
DIAL 1	space	?	,	!	1
DIAL 2	A	B	C	@	2
DIAL 3	D	E	F	#	3
DIAL 4	G	H	I	\$	4
DIAL 5	J	K	L	%	5
DIAL 6	M	N	O	^	6
DIAL 7	P	R	S	&	7
DIAL 8	T	U	V	*	8

DIAL 9	W	X	Y	(	9
DIAL *	:	=	[	]	*

NOTE: When the character you want appears on the same dial pad key as the previous character, press **UP** to move the cursor one space to the right. To cancel an individual alarm and reminder message:

- Press **TRSF** and then dial **112**.
- Dial alarm number **1, 2** or **3**.
- Press the **HOLD** key.
- Press the **TRSF** key.

## PERSONAL SPEED DIAL NAMES

Each personal speed dial number can have an 11 character name assigned to it. This name is used to select the speed dial bin when you are dialing by directory.

- Press **TRSF** and then dial **106**.
- Dial the speed dial bin number **00–49**.
- Write your message using the procedure described in *Alarm Reminder Messages*.
- Press the **TRSF** key to store the speed dial name.
- Repeat for each speed dial bin if necessary.

## STATION NAMES

You can assign an 11 character name to your keyset. This allows other display key-set users to call you using the directory dial feature.

To program a station name:

- Press **TRSF** and then dial **104**.
- Enter the 11 character name using the procedure described in [Alarm Reminder Messages](#).
- Press **TRSF** to store the name.

## MANAGING KEY ASSIGNMENTS

You can view your key assignments and add extenders to some of your programmable keys for easy one touch operation of frequently used features.

- While on-hook, press **TRSF** and then dial **107**.
- Use the **VOL** keys to scroll through all of your programmable keys **OR** press the programmable key to which you want to add the extender.

- When you reach a key listed below, dial the corresponding extender.
- Press **TRSF** to store and exit programming.

KEY	DESCRIPTION	EXTENDER
<b>BOSS</b>	Boss and Secretary	1-4
<b>DP</b>	Direct Pickup	Extension or station group number
<b>DS</b>	Direct Station	Any extension number
<b>FWRD</b>	Call Forwarding	0-7
<b>GCONF</b>	Group Conference	0-5
<b>GPIK</b>	Group Pick-Up	01-20
<b>IG</b>	In/Out of Group	Any group number you are part of
<b>MMPG</b>	Meet Me Page	0-9, *
<b>PAGE</b>	Page	0-9, *
<b>PARK</b>	Park (orbits)	0-9
<b>RP</b>	Ring Plan	(1-6), HOLD for none
<b>PMSG</b>	Programmed Messages	01-30
<b>SG</b>	Station Group	500 or 5000 through 549 or 5049
<b>SPD</b>	Speed Dialing	00-49, 500-999
<b>DIR</b>	Directory	PERS (1), SYS (2) or STN (3)
<b>VT</b>	Voicemail Transfer	Voicemail Group number

NOTE: Confirm that the cursor is placed correctly before you enter the extender.

## LCR WITH CLEAR

When you are making an outside call using LCR and dial an incorrect digit, you can press the **CLEAR** soft key to reenter the telephone number. You do not need to redial **9** to reaccess LCR.

## BACKSPACE WITH LCR

If you misdial while using LCR, you can delete digits shown in the display by pressing the **BSPC** soft key as many times as necessary.

## TEXT MESSAGING

This feature allows two digital keyset users to respond to each other with preprogrammed text messages. After receiving an Off Hook Voice Announcement or Station Camp-On, you may respond with a text message while continuing to talk and listen to your outside party. The other station can view this message and take the appropriate action or respond back with another text message.

You **must** be permitted to use the Text Messaging feature. See your System Administrator or Technician to be assigned this feature.

They will assign you ten (10) blank messages. You can create any 16 character messages (01 to 10) that are appropriate for your use.

Note: Please see [ALARM REMINDER MESSAGES](#) for instructions on how to enter characters to create a text message.

Familiarization with the two digit message numbers you will use the most will make this procedure quick and easy. However if you do not know them, use the **UP/DOWN** button to scroll to the desired message, then press **SEND**.

The basics steps in text messaging are:

1. Press **TMSG** soft key to begin text messaging.
2. Dial the 2 digit number for the desired message.
3. Confirm this is the intended message then press **SEND**.
4. Wait for a reply from the other station (steps 1, 2 & 3)
5. When any station presses **EXIT** the displays at both stations return to their previous call progress condition.

At all times after step 1 you can talk and listen to your caller while repeating steps 2.

The following example will better demonstrate how to use Text Messaging. In this example station 201 is making an off hook voice announcement to station 205 who after hearing the announcement will respond with a text message.

**STATION 201: LINDA**  
received a call on line 702

Talking on line 702

```
702:          01:15
CONF    PAGE    MUTE
```

Press **TRANSFER**

```
Transfer:
RETURN
```

Dial **205**

```
205:busy
OHVA      CAMP ON
```



```
OHVA to 205
```

```
Wait for reply
```

```
ASK THEM TO HOLD
TMSG      EXIT
```



```
702:          01:45
CONF    PAGE    MUTE
```

**STATION 205: JOHN**  
is talking on line 701

```
701:          05:25
```

```
OHVA from 201
TMSG      REJECT
```

```
GIVE THE CALL
TMSG:01    SEND
```

Dial **03** or press ↑ twice

```
ASK THEM TO HOLD
TMSG:03    SEND
```



```
Wait for reply
```

```
701:          05:55
CONF    PAGE    MUTE
```

## WHAT IS CALLER ID?

Caller ID is the name given to the telephone company-provided feature that delivers the telephone number and sometimes the name of the person calling your phone. There are two types of Caller ID; the first delivers the calling party's telephone number only and the second (sometimes referred to as "Deluxe" Caller ID) delivers both the calling party's telephone number and name as listed in the telephone directory.

The phone system can handle both types of Caller ID; in fact, in the case of number only delivery, the system can be programmed to insert a name for a specific telephone number. However, even though you are paying to receive Caller ID information, there are some circumstances that mean you will not receive this information. The six most common reasons are listed below along with the display information that the system will provide.

- |                  |  |
|------------------|--|
| PRIVATE          | The caller does not wish his/her name or number to be revealed to you. This type of call can be stopped at the telephone company by dialing an access code on your outside lines. This will redirect these PRIVATE calls to an announcement that states that you do not wish to receive calls that have had Caller ID blocked. The code to block these calls can usually be found in the front section of the telephone directory. |
| OUT OF AREA      | The caller is calling from an area that cannot provide Caller ID information (for example, international calls) or he/she is calling from a type of circuit that cannot provide Caller ID information, for example, some outbound WATS lines.  |
| PAYPHONE         | The caller is calling from a coin-operated telephone. The telephone company will send this information as there are no directory listings for pay phones. The number will be delivered as usual.   |
| INVALID CID INFO | This is a message that will be displayed when CID information is sent on the line but was somehow corrupted.   |
| NO CID RECEIVED  | This is a message that will be displayed when there was no CID information sent on the line.   |

## NO CID DSP

Caller ID Digital Signal Processors (CIDDSP's) are resources in the system required for receiving CID data. If there are no CIDDSP's available at the time a call comes in, this is the message you will see on your display.

NOTE: The Caller ID features require optional software and/or hardware. Please see your service and installation company for details.

## WHAT IS ANI?

### [T1&E&M NOT SUPPORTED ON THE OS 7030, OS 7100 and OS 7200-S]

ANI (Automatic Number Identification) is a feature offered by some telephone service providers that provides the calling party's telephone number. This service is only available on E&M Tie Lines on a T1, digital trunk. ANI is similar to Caller Identification (CID) but the format and information of the calling person is different. CID uses FSK signalling and ANI uses DTMF signalling. Usually, with ANI, a calling party's identity is the Listed Directory Number (LDN) unless a separate bill-to-number has been specified, (in which case the bill-to-number will be sent). Note that ANI does not provide calling party NAME, only the number. The phone system can provide calling number to name translation table.

## WHAT IS CLI?

On ISDN circuits, calling party information is called CLI and is supported on both BRI (not supported in the US) and PRI type circuits (not supported on OS 7030). On BRI circuits the system only supports number delivery and, like ANI, a name can be attached to the telephone number of frequent callers via the Caller ID translation table. On 5ESS and NI2 PRI circuits both name and number support is provided on the system.

## SELECTING YOUR CALLER ID DISPLAY

Simultaneous display of Caller ID name and number on incoming CO calls on both lines of display keysets is supported on all OfficeServ systems. On transferred CO calls, you can decide if you want to see the Caller ID name or Caller ID number in the display. Regardless of which data is selected, you can press the **NDD** key to view the other pieces of CID information. To select the type of Caller ID information you wish to view:

- With the handset on-hook, press **TRSF** and then dial **119**.
- To set the first line of a ringing call display dial **0**.
- To set the second line of a ringing call display dial **1**.  
Set the data to display from the following:
  - To show nothing dial **0**.

- To show Caller ID Number dial **1**.
- To show Caller ID Name dial **2**.
- To show the DID Number the call came in on dial **3**.
- To show the Name of the DID the call came in on dial **4**.
- To show the Name of the Group the call came in for dial **5**.
- To show the DID Number and then Name of the DID dial **6**.
- To show the Name of the DID and then the DID Number dial **7**.
- To set the top line of the display shown after answering a call dial **2**.  
Set the data to display from the following:
  - To show Caller ID Number dial **0**.
  - To show Caller ID Name dial **1**.
  - To show the DID Number the call came in on dial **2**.
  - To show the Name of the DID the call came in on dial **3**.
  - To show Caller ID Number and then the DID Number dial **4**.
  - To show Caller ID Name and then the DID Number dial **5**.
  - To show the DID Number and then the name of the DID dial **6**.
  - To show the Name of the DID and then the DID Number dial **7**.
  - To show the C.O. line information dial **8**.
- To set the format if the C.O. line information when the above is set to show C.O. line information dial **3**.
  - To show the C.O. line number and the dialed or Caller ID Number dial **0**.
  - To show only the dialed or Caller ID Number dial **1**.
- Press **TRANSFER** to exit and store your selection.

## VIEWING THE NEXT CALLER ID CALL

In the event that you have a call waiting or a camped-on call at your keyset, you can press the **NEXT** key to display the Caller ID information associated with the call in queue at your keyset. Either the CID name or CID number will show in the display depending on your Name/Number selection.

To view Caller ID information for calls that have been camped-on to your keyset, press the **NEXT** key. If your keyset does not have a **NEXT** key, press the **CID** key and then the **NEXT** soft key.

## SAVING THE CALLER ID NUMBER

At any time during an incoming call that provides CID information, you may press the **SAVE** key to save the CID number. If your keyset does not have a **SAVE** key, press the **CID** key, the **SCROLL** key and then the **SAVE** soft key. The system must be using LCR to dial the saved number.

## REDIALING A SAVED CALLER ID NUMBER

To redial a number that has been saved, press the **SNR** key or dial **17**.

### NOTES:

1. Your telephone system must have LCR correctly programmed to redial the saved number.
2. If the Hot Keypad feature has been turned off, you must first lift the handset or press SPK before you begin dialing.

## STORING A CALLER ID NUMBER

At any time during an incoming call that provides CID information, you may save the CID number as a speed dial number in your personal speed dial list. To store a Caller ID number in a personal speed dial bin:

- Press the **STORE** key. The system displays the speed dial bin in which the number was stored, **OR**
- Press the **CID** key and then press the **SCROLL** key.
- Press the **STORE** soft key.
- The system displays the speed dial bin in which the number was stored.

**NOTE:** Your telephone system must have LCR correctly programmed to redial the saved number. If LCR is not being used on your system, you will not be allowed to STORE CID numbers.

## INQUIRE CALLER ID PARK/HOLD INFO

If you are informed that an incoming call is on hold or has been parked for you, you may view the Caller ID information before you retrieve the call. This will influence how you choose to handle the call.

From an idle keyset:

- Press the **INQUIRE** key, **OR**  
Press the **CID** key and then the **INQUIRE** soft key.
- Dial the trunk number.
- You may now answer the call by pressing **ANS**, **OR**  
You may use **NND** to view more information about this call, **OR**  
You can return to the idle condition by pressing **IGNORE**.

If you are on a call:

- Press the **INQUIRE** key. Your existing call will go on hold, **OR**  
Press the **CID** key and then the **INQUIRE** soft key to place the first call on hold.
- Dial the trunk number.
- You may now answer the call by pressing **ANS**, **OR**  
You may use **NND** to view more information about this call, **OR**  
You can return to the idle condition by pressing **IGNORE**.

### NOTES:

1. If you are on an intercom call or you have Automatic Hold turned off, you must finish the existing call or place it on hold before inquiring.
2. If you inquire about an outgoing call, you will receive a [call no longer available] display.

## REVIEWING PAST CALLER ID CALLS

This feature allows you to review CID information for calls sent to your keyset. This list can contain 10–50 calls in a last-in, first-out basis. The list includes calls that you answered and calls that rang your keyset but that you did not answer. When reviewing this list, you can press one button to dial the person back. The system must be using LCR to dial the stored number. To access the CID information stored in your REVIEW list:

- Press the **REVIEW** key, **OR**  
Press the **CID** key and then press the **REVIEW** soft key.
- If you have entries in your review list, the most recent call will be shown first.
- You can now **CLEAR** this entry, **OR**  
Use **NND** to view more information about this call, **OR**  
Press **DIAL** to call this person back, **OR**  
Press **SCROLL** and then press **STORE** to save this number in a personal speed dial bin.

### NOTES:

1. Each keyset defaults with ten review bins. Please see your system administrator to determine the number of bins assigned to your keyset.
2. Your system must have LCR correctly programmed to allow you to **DIAL** numbers from the review list or to **STORE** entries from the review list.



## ADD-ON MODULE

### 32 BUTTON MODULE WITH KEYSSET

[NOT SUPPORTED ON THE OS 7030 and OS 7100]

The 32 button module is used when you need more programmable keys added to your keyset. The 32 tri-colored LED's provide better visual indication of call status and call progress. The extra programmable keys are used exactly like the one on your keyset. Make them DSS/BLF keys or any combination of feature keys. The 32 button does not support executive off-hook voice announce (OHVA) and does not have a microphone. A maximum of four 32 button modules can be assigned to any keyset.

### 64 BUTTON MODULE WITH KEYSSET

The 64 button module is used when you need more programmable keys added to your keyset. The 64 red LED's provide visual indication of calls and features. The extra programmable keys are used exactly like the ones on your keyset. Make them DSS/BLF keys or feature keys. As a DSS/BLF the size of the 64 button module allows for greater call status and faster call processing. The 64 button module does not support executive off-hook voice announce (OHVA) and does not have a microphone. A maximum of four 64 button modules can be assigned to any keyset.

## Samsung Voicemail

This section describes how to setup and use the various features available to a Subscriber. A Subscriber is a person that has been authorized access to the various features and services available in the Samsung Voicemail. Please review this section carefully before you use your Authorized Features and Services, known as Subscriber Services.

Voicemail is one of the Subscriber Services available. Your voicemail box has the capability of storing private messages, and offers a number of options for sending or redirecting messages as well as provides several ways to notify you of new messages.

Another very common Subscriber Service is Access Manager. This allows you control over when and where you receive your calls as well as what to speak to your callers in the event you are unable to speak to them directly. The 'events' are referred to as "Call Conditions". No-Answer, Busy, and Blocked are the most commonly used Call Conditions.

This guide can be used by Subscribers from within the office or from telephones outside the office. The basic operation is the same, but the access method will be different. [See the Samsung Voicemail Subscriber Services Menu Diagram for more details.](#)

Note that some features and prompts detailed here may not be available to all Subscribers. See your System Administrator if you have questions about feature availability.

# Samsung Voicemail Subscriber Services Menu

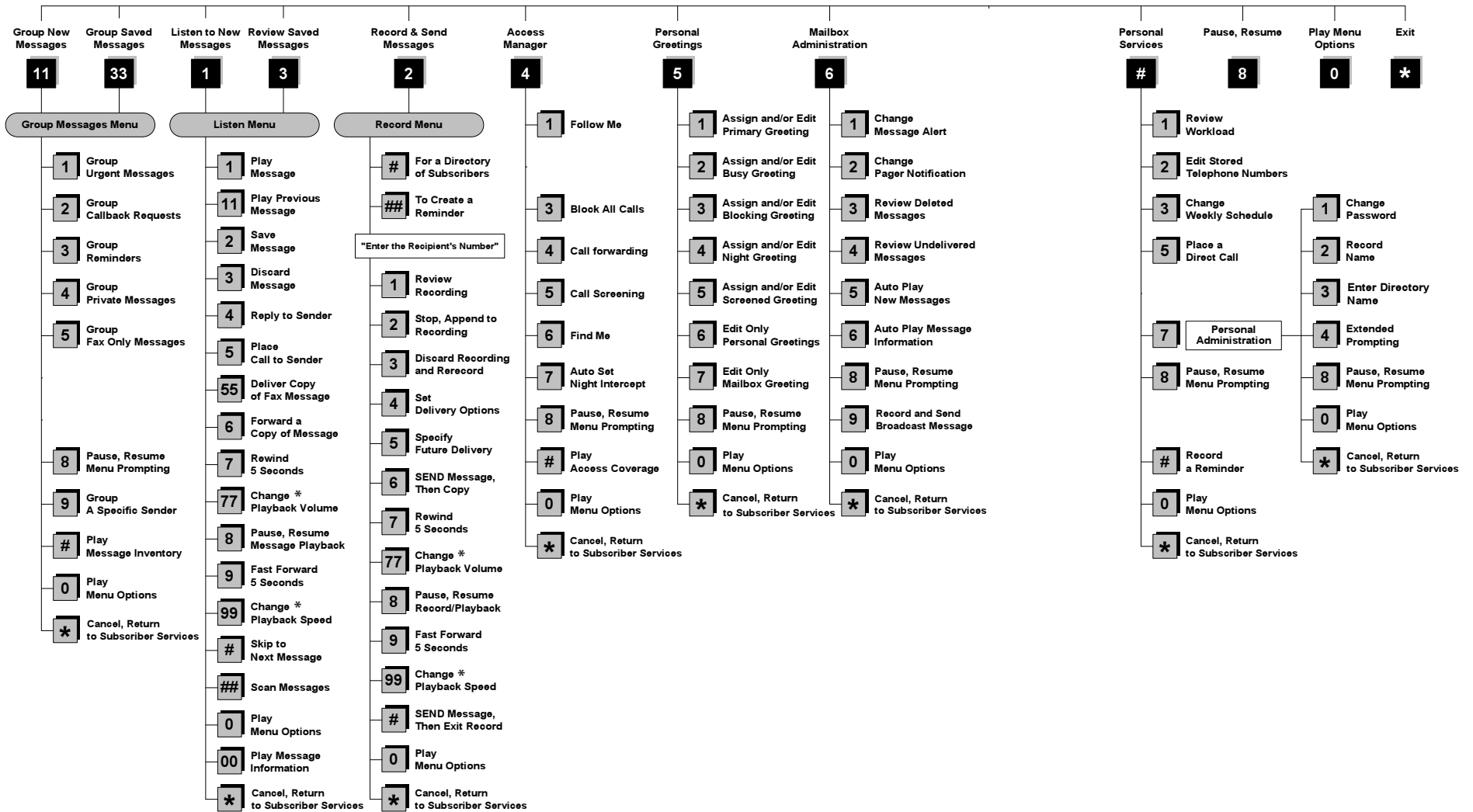

NOTE: All options shown MAY NOT be authorized. If an option is not available please speak to your system administrator.

\*Change Playback Volume and Speed not available on the OfficeServ 7030, OfficeServ 7100, OfficeServ 7200-S or the OfficeServ IP-UMS.

# ACCESSING YOUR MAILBOX

*[Also known as Subscriber Services Menu]*

## Inside Callers *[Subscriber logging in from their Desk]*

- Dial the voicemail access number or press the key assigned to ring the voicemail [VMMSG].
- Enter your personal password when prompted (the default password is 0000).

## Outside Callers *[Subscribers calling from Cell Phones or outside of the office environment]*

- Dial the phone number that will be answered by the voicemail. The main greeting will answer.
- At the main greeting dial [#] plus your Subscriber (or mailbox) number (Subscriber and Mailbox numbers will usually match your extension number).
- Enter your personal password when prompted (the default password is 0000).

## Access your Subscriber Services (or Mailbox) from a Station other than your Own (or checking a mailbox associated with a different station)

- Press the [VMMSG] key or dial the voicemail **group number**. You will be prompted to enter a password.
- Press [\*]. This will take you to the Main Auto Attendant Menu.
- Press [#] plus the Subscriber number of your choice. You will be prompted to enter you password.

At this point the inside and outside callers follow the same instructions. You will hear a message stating the number of messages left in your mailbox. You will then hear the Subscriber Services Menu with the following options:

- 1 Listen to New Messages - [See Listening to your Message.](#)
- 2 Record and Send Message - [See Sending Messages.](#)
- 3 Review Saved Messages - [See Listening to your Message.](#)
- 4 Access Manager - [See Access Manager.](#)
- 5 Personal Greetings - [See Personal Greetings.](#)
- 6 Mailbox Administration - [See Mailbox Administration.](#)
- # Personal Services - [See Personal Services.](#)
- \* Return to Main Menu.

# GETTING STARTED

Using your new Subscriber Services is as simple as following a few simple spoken instructions. First time users should read this section as a tutorial. You should start with the following steps:

- Access your Subscriber Services Menu - You already know how to do this.

## From the Subscriber Services Menu:

- Record a Primary/No-Answer Personal Greeting. Dial [5][1].
- Record a Mailbox Greeting. Dial [5][7].
- Change your access code (Password). Dial [#][7][1].
- Record your name. Dial [#][7][2].
- Enter your directory name. Dial [#][7][3].

After you have completed the steps above your Subscriber Services are set up and ready to use.

# LISTEN TO YOUR MESSAGES

If there are new messages in your mailbox your [VMMSG] key will be lit. Call the voicemail by pressing this key, and when prompted enter your password. You will then be at the Subscriber Services Menu. Select [1] to listen to new messages or [3] to listen to saved messages.

Note: After you enter your password, if "Autoplay of New Messages" is enabled and you have new messages the voicemail will begin to play them automatically. A subscriber can control this feature. From the Subscriber Services Menu [6] [5] toggles "Autoplay of New Messages" ON/OFF.

# SUBSCRIBER SERVICES MENU

The following is a list of all the options available in the Subscriber Main Menu.

- 1 LISTENING TO NEW MESSAGES
- 11 GROUP NEW MESSAGES
- 2 RECORD AND SEND A MESSAGE
- 3 LISTENING TO OLD MESSAGES
- 33 GROUP OLD MESSAGES
- 4 ACCESS MANAGER
- 5 PERSONAL GREETINGS
- 6 MAILBOX ADMINISTRATION
- 8 PAUSE / RESUME

- 0 PLAY MENU OPTIONS
- \* EXIT TO AUTO ATTENDANT
- # PERSONAL SERVICES

## 1 or 3

### LISTENING TO OLD OR NEW MESSAGES

- 1 Play / replay the message you just heard.
- 11 Play the previous message.
- 2 Save the message you just heard and listen to the next message.
- 3 Delete the message you just heard and listen to the next message.
- 4 Reply to the message.  
This will allow you to leave a message in the mailbox of the sender (if the sender has a mailbox on this system).
- 5 Return the call directly to the telephone number that left the message.  
This will work for internal and external callers, but Caller ID service is needed to use this feature on an outside call.
- 55 Deliver a fax copy.  
This will allow you to receive attached faxmail document(s). Faxmail documents can be delivered to any fax machine of your choice as long as out calling is authorized. You can also have faxmail messages automatically delivered to the fax machine of your choice.
- 6 Forward the message and saves a copy.  
The subscriber can be selected by dialing their mailbox number (nnn), using the directory service (#) or you may also add comments and leave it as a memo to yourself (##).  
The Send and Copy Service (option 6) allows a user to send copies of a message to multiple recipients easily. A different introduction message may be left for each recipient.
- 7 Rewind the message 5 seconds.
- 77 Change playback volume of the recording. [Not available on OS 7030, OS 7100, OS 7200-S or OS IP-UMS]  
There are two levels of volume during playback. Dialing this code will toggle between the two levels.
- 8 Pause or resume during message playback.
- 9 Fast forward the message 5 seconds.

- 99 Change playback speed of the recording. [Not available on OS 7030, OS 7100, OS 7200-S or OS IP-UMS]  
There are two levels of speed during playback. Dialing this code will toggle between the two speeds.
- 0 Play options.  
Pressing this key will play all the menu options available to you from this point.
- 00 Hear the time and date, and sender's information of the message you just heard. Sender information is not available on outside calls.
- # Move to the next message. This does not Save or Discard the current message - it is retained as new.
- ## Scan. Plays first 7 seconds of a message then skips to next message. This is similar to the scan button on a radio. It will allow you to find a specific message quickly. To stop scanning press [1].
- \* Cancel and return to previous menu.

## 11 or 33

### GROUP NEW OR OLD MESSAGES

Messages can be grouped as either Reminders, press [3] or Messages from a specific sender, press [9].

Additionally you can press [#] and hear a summary of your mailbox contents:

- a) Number of messages
- b) Number of reminders
- c) Number of urgent messages
- d) Number of messages needing a callback
- e) Number of private messages
- f) Number of fax messages

## 2

### RECORD AND SEND A MESSAGE

This option is used to send a message to another subscriber. The steps are simple:

- a) Enter the recipient's mailbox number, or if this is not known enter [#] to use the system directory.

b) Record your message at the tone. After recording the message, you will hear the Send Menu with the following functions:

- 1 Review
- 2 Continue Recording
- 3 Discard and Re-Record
- 4 Set Message Attributes (Delivery Options)
- 5 Schedule Future Delivery
- 6 Save and Send then Send a Copy to Someone Else
- # Save and Send the Recording

## Setting Message Attributes

If after recording a message you select [4] you can set up any combination of the following delivery options:

- 1 Urgent Delivery
- 2 Return Receipt Requested
- 3 Request a Call Back
- 4 Private Delivery
- 5 Reply Required
- \* Exit

## Scheduling Future Delivery

If after recording a message you select [5] to schedule future delivery, you will be able to set message attributes and set this message as:

- # Immediate Delivery
- 1 Next Few Hours
- 2 End of Current Business Day (based on your Availability Schedule)
- 3 Beginning of Next Business Day (based on your Availability Schedule)
- 4 A Coming Day of the Week
- 5 Specific Day / Time
- \* Exit

# 4

## ACCESS MANAGER

The Access Manager allows the subscriber to set a number of options for when, where and how, and/or if the voicemail contacts you when a caller dials your extension number. All of the options are toggled on/off based on their current status when you access them.

**Note: ALL** Access Manager options **MUST** be individually allowed by the System Administrator for each Subscriber. They are:

### 1 Follow Me

Allows the subscriber to enter an alternate location and set how long the new destination (Designated Location) will be active. This number may be an internal or external number. This is useful if you are frequently traveling or changing the number where you can be reached.

When Follow Me is activated, the transfer will be supervised and confirmed. This means that if the call is not answered or if rejected by the Subscriber at the designated location it will be recalled to the Subscriber's mailbox.

### 3 Call Blocking

When this feature is active, callers will not be transferred to your extension, they will hear your 'blocked' greeting (if recorded) and will go directly to your mailbox if they do not select any or are not offered any other options.

### 4 Call Forwarding

Unlike Follow Me where the subscriber wants to take their calls at an alternate location this feature allows the subscriber to pass control of his calls to another Subscriber. The "Forwarded To" Subscriber will now be in control of the caller and the caller will NOT return to originating Subscriber's Mailbox. If the "Forwarded To" Subscriber does not answer the caller it will now follow what ever the "Forwarded To" Subscriber has set up for their call conditions. The Caller will hear "Forwarding to" "{Subscriber Name}" before actually being forwarded.

### 5 Call Screening

If this is turned on, the caller will be asked their name and the voicemail will play this name to you before the transfer, giving you an option to accept or reject the call.

### 6 Find Me

Find Me, when enabled, will attempt to locate the subscriber by calling a list of preprogrammed phone numbers. The stored phone numbers are entered in 'Personal Services' [#][2] (if allowed by the Administrator). The stored telephone number list can contain up to 9 preprogrammed telephone numbers. The Find Me feature only use the first five.

### 7 Night Intercept

This feature is dependent on your weekly availability schedule, which is entered in 'Personal Services' [#][3] (if allowed by the Administrator). When Night Intercept is active the voicemail will first ring your extension then play

your primary, No Answer greeting during the day (when you are available) and will NOT ring your extension but simply play your Night greeting during the night (when you are not available).

**Note:** This does NOT use the Day and Night schedules of the phone system. It is solely controlled by the Subscriber's Availability Schedule.

## 8 Pause / Resume

## \* Exit from Access Manager

## 0 Play All Options

## # Play Access Coverage

This feature is useful for finding out how your current access settings are set. It will also tell you what greetings will play under each of the call conditions you have setup.

# 5

## PERSONAL GREETINGS

The options available in this menu will be determined by your System Administrator, and not all of them may be available to you. In the simplest systems, only a mailbox greeting will be available, additional greetings may be accessible in more complex systems.

Your Personal Greeting will be played every time someone dials your extension and you do not answer.

You may record up to 9 Personal Greetings, and you may assign any one of them to be active. There are several different 'Call Coverage' conditions to which you may assign any of your 9 greetings. The Call Coverage Conditions are: No-Answer, Busy, and Do Not Disturb (or Forwarded All). This will allow different greetings to play depending on the type of call forward that you have set, or the condition of your telephone.

The Call Coverage conditions that you can assign specific greetings to are selected by the following digits:

### 1 Primary/No Answer Greeting

Used when in your office, away from your desk or during the time period you are scheduled available. If this is the only Personal Greeting you record, it will play for all call coverage conditions.

This option is available only if the Administrator has assigned you the 'Basic Greeting' feature.

Example: "Hi this is John Smith. I'm sorry I am not available to answer your call. If someone else can help you, please enter the extension number now. Or, to leave me a message, press 1."

### 2 Busy Greeting

Played to a caller when you are already talking to someone on your extension or the telephone at your Designated Location.

This option is available only if the Administrator has assigned you the 'Busy Greeting' feature.

Example: "Hi, this is John Smith. I'm on another line right now. If someone else can help you, please enter the extension number now. Or, to leave a message, press 1."

### 3 Call Blocking Greeting

Used while Call Blocking is enabled in your Access Manager or if your phone is forwarded ALL or DND.

This option is available only if the Administrator has assigned you the 'Call Blocking' feature.

Example: "Hi, this is John Smith. Sorry I missed your call, but I'm going to be out of the office for the next few hours. If someone else can help you, please enter the extension number now. Or, to leave me a message, press 1."

### 4 Night Greeting

Used during the time period you are scheduled UNAVAILABLE, usually after business hours during the evening and at night.

This option is available only if the Administrator has assigned you the 'Scheduling' feature.

Example: "Hi, this is John Smith. I've left the office for the evening. If you would like to try someone else, please enter the extension number now. Or, to leave me a message, press 1."

### 5 Call Screening Greeting

Used while Call Screening is enabled, and you REJECT a caller after listening to the caller's record name.

This option is available only if the Administrator has assigned you the 'Call Screening' feature.

Example: "Hi, this is John Smith. I'm sorry, but I am not available to speak with you at this time. If someone else can help you, please enter the extension number now. Or, to leave me a message, press 1."

## 6 Edit Personal Greetings

You may also edit/record each one of the greetings (1-9) at any time.

Select a greeting number to edit and follow the instructions to record your greeting. When you are done recording your greeting, you will be able to listen to the greeting you recorded, save the greeting you recorded and return to the previous menu, record the greeting again, or exit without saving the greeting.

Note: If you record only the greeting assigned to the No-Answer Call Coverage Condition, then that greeting will play to callers for all Call Coverage Conditions (No-Answer, Busy, Blocked, Night, and Rejected Caller). In this case, the salutation part of the greeting should be very general.

## 7 Edit Mailbox Greeting

Used whenever a caller reaches your mailbox or if you have not recorded any of the Call Coverage greetings. The way a caller is transferred to your mailbox greeting directly, is by another subscriber transferring the caller to your mailbox using the VT (VoiceMail Transfer) key.

This option is available only if the Administrator has assigned you the 'Mailbox Greeting Option' feature.

Example: "Hi, this is John Smith. Please leave me a message, I will call you as soon as I can."

Note: This greeting will only play if none of the 5 personal greetings has played to the caller. A common usage for this Greeting is when another Subscriber is talking with a caller and uses the VT key on their phone to transfer the caller directly to your Mailbox.

# 6

## MAILBOX ADMINISTRATION

The Mailbox Administration menu is used to turn on and off your pager notification, message alert options and other message control features.

### 1 Message Alert

When this function is activated, the voicemail will call any outside or inside telephone number, after each message is left in your voice mailbox.

To hear your message at the remote location when the voicemail calls you, after you pick up the telephone and answer you will be instructed that there is a message and to enter your password. Simply enter your password and you will now be logged in.

### Setting Up Message Alert:

- From the Subscriber Services Menu press **[6]** for Mailbox Administration.
- Press **[1]** for Message Alert.
- There are 4 options available to you:
  - Press **[1]** to toggle message alert on and off.
  - Press **[2]** to set the schedule when you would like to be notified.
  - Press **[3]** to be notified on urgent messages only.
  - Press **[4]** to set the destination phone number.

### 2 Pager Notification

When this function is activated, the voicemail will call your beeper service and notify you after each message is left in your voice mailbox.

- From the Subscriber Services Menu press **[6]** for Mailbox Administration.
- Press **[2]** for pager notification.
- There are 4 options available to you:
  - Press **[1]** to toggle pager notification on and off.
  - Press **[2]** to set the schedule when you would like to be paged.
  - Press **[3]** to be notified on urgent messages only.
  - Press **[4]** to set the pager phone number.

### 3 Undelete

When this function is activated, the voicemail will allow you to undelete any messages that you have recently deleted (up to the programmed Daily Maintenance Time, which is set to 3 a.m. by Default the following morning).

- From the Subscriber Services Menu press **[6]** for Mailbox Administration.
- Press **[3]** for Deleted Messages.

Deleted voicemail messages are temporarily stored in memory until 3 a.m. the following day. Select this option to recover ("undelete") previously deleted messages, during this period of time.

### 4 Undelivered Retrieval

When this function is activated, the voicemail will allow you to recall any messages you have sent that have NOT yet been picked up by the recipient.

This useful feature will allow you to cancel any messages that have NOT yet been picked up by the recipient.

## 5 Auto Play New Messages

If this option is enabled, after you enter your password correctly any new messages will immediately begin to play. To enable (or if already enabled toggle and disable) this feature:

- From the Subscriber Services Menu press [6] for Mailbox Administration.
- Press [5] to Set Auto Play of New Messages.

## 6 Auto Play Message Information

If this option is enabled, the date, time and sender's name will be played automatically before each message. If this is disabled, the information must be requested manually by pressing '00'. To enable (or if already enabled toggle and disable) this feature:

- From the Subscriber Services Menu press [6] for Mailbox Administration.
- Press [6] to Set Auto Play of Message Information.

# 9

## MESSAGE BROADCAST

This option will only be available if it has been allowed by the System Administrator.

### Broadcast to All Mailboxes

If you have been designated as a Subscriber Administrator, you may send a message to ALL mailboxes in the system.

- From the Subscriber Services Menu press [6] for Mailbox Administration.
- Press [9] for Broadcast Messages.

This option will only be available if your mailbox has been assigned Subscriber Administration privileges.

# #

## PERSONAL SERVICES

The Personal Administration Menu is used to set your password and record your name. Many of these features must be allowed by the System Administrator.

### 1 Workload Management

Allows you to access to all reminders, both Active and Pending. If authorized you can group your reminders as Commitments, Follow-Ups or Tasks for better organization. The system will flag each reminder as Active or Pending (pending means scheduled for future delivery).

### 2 Stored Numbers

Allows you to enter up to 9 stored phone numbers. The first five of these are used in the 'Find Me' feature, but any of them (1-9) can be easily dialed using only one digit followed by the pound key, to be used by many other features from within your subscriber space. (ie: "Follow Me," "Message Alert," "Pager Alert," and "Direct Call").

### 3 Schedule Availability

Allows you to enter a weekly availability schedule for use with Night Personal Greeting and the Auto Night Intercept feature. Follow the spoken directions to enter the days of the week and times you are generally available to talk to your callers. All other times you will be considered unavailable.

### 5 Place a Direct Call

Allows you to place a direct call out of the voicemail from anywhere. You may either dial the number or dial a single digit 1-5 that corresponds to a stored number ([See Personal Services, 2 - Stored Numbers](#)). This feature must be authorized by the System Administrator and can be limited or opened to internal, local, and long distance calls.

### 7 Personal Administration

This area is used during the initial set up of your Subscriber Settings ([see next section](#)).



## PERSONAL ADMINISTRATION SETTINGS

This menu allows you to make changes to basic setup settings, that are rarely changed. Use these when you initially set up your personal Subscriber settings. You probably will not need to change them after that.

### 1 Setting your Password

- From the Subscriber Services Menu press **[#][7][1]**.
- The current password will be played and you will have the chance to change it.

### 2 Recording your Name

Use this option to record your name. Your recorded name is played in several different situations. It is important to record your name for proper operation of the voicemail system.

- From the Subscriber Services Menu press **[#][7][2]**.
- The current name will be played and you will have the chance to change it.

Note: It is possible that if you do not record your name and/or enter your Directory Name (described below), you will not be included in the Dial by Name Directory.

### 3 Entering your Directory Name

Use this option to enter your Directory Name. Your Directory Name is used by callers to find you if they do not know your extension number.

- From the Subscriber Services Menu press **[#][7][3]**.
- The current Directory Name will be played as a string of digits that are equal to your name spelled out on your telephone keypad. Follow the instructions to enter a new name. You will be prompted to enter your last name and then your first name.

This must be done in order for the directory feature to work correctly.

Note: It is possible that if you do not record your name (described above) and/or enter your Directory Name, you will not be included in the Dial by Name Directory.

### 4 Extended Prompting

Use this option to drastically reduce the number of prompts played in the subscriber interface (mailbox prompts). Change this setting only if you are very familiar with the user operation of the voicemail.

Note: Remember if you know what digits to press, you can enter them at any time you do not have to wait to be prompted. This feature can be toggled on/off at anytime. Also if it is off you will be prompted within each subscriber menu to press zero for more options. This enables you to still be able to find out what to do if you were to get lost and extended prompting was disabled.

## KEYSET USER FEATURES

The following options are available if you have a display keyset. They require setup by the System Administrator.

### Message Waiting Lights

When new messages are left in your mailbox, the voicemail message light on your keyset will flash. Press this flashing key **[VMMMSG]** and follow the prompts to retrieve messages. This key may be pressed at any time to log into your Subscriber Main Menu.

### Answer Machine Emulation

If you have an Answer Machine Emulation key programmed on your keyset, you can use it to monitor calls going to your voicemail, and optionally answer them. The operation of this feature is similar to screening a call on a home answering machine.

Your keyset must be set to forward on no answer to voicemail. After ringing your station the caller will be connected to your voicemail and hear your personal greeting before leaving a message. During this time you will be monitoring the connection between the caller and your voicemail box. At this time you will only be monitoring the call, you can not talk to the other party until you answer. You may pick up the call at any time or ignore it.

To activate this feature press the **AME** button. The associated indicator will be lit steady. Press again to turn off. If this key is pressed while a station is ringing (during forward no answer), the feature will be turned on for the current call only.

While the caller is leaving a message or ringing you may:

- Press **[#]** to immediately put the caller in your voice mailbox and monitor it.
- Press **[\*]** to immediately disconnect your station. The caller continues to leave a message normally.
- Pick up the handset and monitor privately.
- Press **ANS / RLS** to answer the call (using the handset or speaker).

## AME Password

If your keyset has **AME PASSWORD** (MMC 110) set to **YES**, you must enter your station password to listen to messages being left. This will prevent unauthorized people from listening to messages being left for you.

If the password option is turned on, while a message is being left, press the flashing **AME** indicator and enter your station password (not your voicemail password). You will then hear the message being left.

## Call Record

If you have a call record button assigned to your phone, you may press it at any time, to record the conversation in progress. If you have a display keyset, you will also have the soft key options to pause and time the message.

## SHORTCUTS

### Calling

Calling a station that is busy or does not answer you can press **[#]** to immediately send the call to the called parties mailbox.

### Call Divert to Voicemail

While receiving an incoming (ringing) call, dial **[\*]** to immediately send the caller to your personal voicemail box. This will override the call forward no answer setting.

### Direct Messaging

**[#] + DSS** To make it easy to leave messages for others in your office without having to dial their extension number first, keyset users may simply dial **[#]** plus a mailbox (extension) number and leave a message directly. If you dial a busy extension press **[#]** to connect directly with the mailbox.

### Self Memo (Reminder)

Pressing **[##]** will leave a message in your own mailbox. This is useful to remind yourself of things to do now or in the future. Messages can be sent with future delivery so you can have the system call you when items become due.

## INTERACTIVE DISPLAYS

Display keyset users have the added advantage of using the soft keys and displays to play, save, delete, reply, call, forward, rewind, pause, fast forward, change the volume, get message information, or help.

### Viewing Mailbox Contents

If you have new messages, in addition to the Terminal Status Indicator (TSI) you will be able to use the keyset displays and soft keys to communicate with the voicemail.

## E-MAIL GATEWAY (EMG)

The E-Mail Gateway feature integrates your voicemail box with your email client. No matter what email client software you are using or where you use it, you can send voicemail messages and fax mail messages to your E-Mail inbox.

There are two parts to the E-Mail Gateway; E-Message Delivery and E-Message Notification.

1. **E-MESSAGE DELIVERY:** Voicemail messages (.wav) and/or fax mail messages (.tiff) are "delivered" to your Inbox with the appropriate attached file.
2. **E-MESSAGE NOTIFICATION:** You will receive an e-mail, with NO attachments, notifying you that you have a voice and/or fax mail message in your Voicemail Box.
  - As a subscriber you can use either E-Message Delivery and/or E-Message Notification.
  - As a subscriber you can have multiple e-mail addresses. (a maximum of 5 valid email addresses).
  - E-Message Notification can be set to one e-mail address while E-Message Delivery is set to different e-mail address.

## Functionality

- With either type of EMG, when Caller ID (CID) is provided, the callers telephone number will appear in the subject field of the email along with the date and time stamp of when the voice message was originally recorded in your Voicemail Box.
- If the caller is also a subscriber on the system and the E-Mail Gateway is set up with a valid "Reply To" address, the Subscriber's name will also appear in the "From" field. Otherwise, the "From" field will display the name of the Samsung voicemail system sending the message.
- Client will use their PC's Multi-Media kit (equipped with either speakers and/or a headset) to listen to messages delivered to their e-mail Inbox.

**IMPORTANT NOTE:** If the PC/Laptop/PDA/Smart Phone/etc... is not equipped with hardware and software capable of playing a '.WAV' file then the E-Mail Gateway will not work for them until they add some method to listen to '.WAV' files delivered to their Inbox.

The same applies to Fax Mail messages, if the device the subscriber is using does not support the viewing of '.TIFF' files, then the E-Mail Gateway for Fax Mail will not work for them until they add some method to view .tiff files delivered to their inbox.

- No Synchronization of messages is performed between the Voicemail Box and the E-mail Inbox.
  - Messages listened to, forwarded, deleted, and/or saved within an e-mail inbox will NOT effect the status of that same new message in the Voicemail or the MWI (Message Waiting Indicator) associated with that message on the phone.
  - Also messages listened to in the Voicemail, from a phone, will not change the Unread/Read status of the same message in an e-mail inbox.

- However, the Voicemail Administrator can adjust parameters per subscriber or group of subscribers that decide how, when, or if to delete the original voice message after it is sent to the E-Mail Server.
- When full synchronization of messages between Voicemail Box and E-mail Inbox is required, ask your Samsung representative about the OfficeServ IP-UMS. This is an Internet Protocol based fully synchronized Unified Messaging System.

## Benefits

- Store and Archive Voice and Fax Mail Messages in visible folders.
- Voice and Fax Mail Messages can now easily be dragged and dropped into folders the same way e-mail messages are organized and saved.
- Voice and Fax Mail Messages are now essentially the same as any other e-mail message.
- Backups and Message Archives can be made when they are made for all other types of e-mail messages.
- Add text notes and comments to use for reference later.
- Some (if not all) e-mail clients will allow you to edit the body of the e-mail to add comments.
- Some will allow you to edit the subject field to help you find a particular message quickly in a large archive of messages.
- Call Back Numbers and Date & Time Stamp are easily displayed in the Subject field.
- Easily forward Voice messages received, to others even if they are not a Voicemail Subscriber on your system.
- No EMG System or Client Software to load on your Local PC or Network Servers.

Therefore compatible with most:

- E-Mail providers and E-Mail Clients
- PCs, Laptops, PDA, and/or Smartphones

**NOTE:** If you are not sure you have this functionality on your system and you would like to use it, please contact your on Site system administrator to see if it is available.

## PERSONAL SPEED DIAL NUMBERS

CODE	NAME	TELEPHONE NUMBER
00	_____	_____
01	_____	_____
02	_____	_____
03	_____	_____
04	_____	_____
05	_____	_____
06	_____	_____
07	_____	_____
08	_____	_____
09	_____	_____
10	_____	_____
11	_____	_____
12	_____	_____
13	_____	_____
14	_____	_____
15	_____	_____
16	_____	_____
17	_____	_____
18	_____	_____
19	_____	_____
20	_____	_____
21	_____	_____
22	_____	_____
23	_____	_____
24	_____	_____

80

## PERSONAL SPEED DIAL NUMBERS

CODE	NAME	TELEPHONE NUMBER
25	_____	_____
26	_____	_____
27	_____	_____
28	_____	_____
29	_____	_____
30	_____	_____
31	_____	_____
32	_____	_____
33	_____	_____
34	_____	_____
35	_____	_____
36	_____	_____
37	_____	_____
38	_____	_____
39	_____	_____
40	_____	_____
41	_____	_____
42	_____	_____
43	_____	_____
44	_____	_____
45	_____	_____
46	_____	_____
47	_____	_____
48	_____	_____
49	_____	_____

81



**OfficeServ™**  
System Administration Guide



**SAMSUNG**

# TABLE OF CONTENTS

## SYSTEM ADMINISTRATION AND SPECIAL FEATURES GUIDE

for  
OfficeServ™ 7000 Series

May 2010

<b><u>ABOUT THIS BOOK</u></b> .....	1
-------------------------------------	---

### **SPECIAL FEATURES**

<u>System Ring Plans</u> .....	2
<u>Manual Ring Plan Change</u> .....	2
<u>Temporary Ring Plan Override</u> .....	2
<u>Calling The System Operator</u> .....	3
<u>Operator Recalls</u> .....	3
<u>Executive Barge-in</u> .....	3
<u>Walking Class of Service</u> .....	4
<u>In/Out of Group</u> .....	4
<u>Direct Inward System Access (DISA)</u> .....	5
<u>DISA Security</u> .....	6
<u>Forced Account Codes</u> .....	6-7
<u>Authorization Codes</u> .....	7
<u>Using the Tie Line</u> .....	8

### **CALLER ID SPECIAL FEATURES**

<u>Abandon Call List</u> .....	9
<u>CID on SMDR</u> .....	9
<u>Number to Name Translation</u> .....	9

Samsung Telecommunications America reserves the right without prior notice to revise information in this guide for any reason. Samsung Telecommunications America also reserves the right without prior notice to make changes in design or components of equipment as engineering and manufacturing may warrant. Samsung Telecommunications America disclaims all liabilities for damages arising from the erroneous interpretation or use of information presented in this guide.

## **SYSTEM ADMINISTRATOR PROGRAMMING**

<a href="#">Customer Level Access .....</a>	<a href="#">10</a>
<a href="#">Customer Level Access Using the PROG Key .....</a>	<a href="#">10</a>
<a href="#">Changing Feature Passcode .....</a>	<a href="#">11</a>
<a href="#">Set Date and Time Display .....</a>	<a href="#">11-12</a>
<a href="#">Reset Station Passcodes to Default .....</a>	<a href="#">12-13</a>
<a href="#">Program Station Names.....</a>	<a href="#">13-15</a>
<a href="#">Program Trunk Names.....</a>	<a href="#">16</a>
<a href="#">Program Station Group Names .....</a>	<a href="#">17</a>
<a href="#">Program System Speed Dial Numbers .....</a>	<a href="#">18-21</a>
<a href="#">Program System Speed Dial Names.....</a>	<a href="#">22</a>
<a href="#">Program Personal Speed Dial Numbers for Other Stations .....</a>	<a href="#">23-24</a>
<a href="#">Program Personal Speed Dial Names for Other Stations .....</a>	<a href="#">25-26</a>
<a href="#">Create Programmed Station Messages .....</a>	<a href="#">26</a>
<a href="#">Set Alarm/Appointment Reminder with Message .....</a>	<a href="#">27-28</a>
<a href="#">Managing Key Assignments .....</a>	<a href="#">28</a>
<a href="#">Programming Account Codes .....</a>	<a href="#">30</a>
<a href="#">Station Timers.....</a>	<a href="#">31</a>
<a href="#">Adding Names to the Translation Table .....</a>	<a href="#">32</a>
<a href="#">Holiday .....</a>	<a href="#">34</a>
<a href="#">Customer Set Relocation.....</a>	<a href="#">35-36</a>

## **SYSTEM MAINTENANCE ALARMS** .....

[37](#)

## **ABOUT THIS BOOK**

This book contains instructions for special features that every telephone user may not need to know. The owner can decide who the system administrator will be and who will have access to these features. Station users can be trained on only the items that apply to them. This procedure will help control costs and telephone abuse.

Several of the features listed in this book are specific to the system operator or attendant position. You can have more than one operator or set your system up to be used without an operator.

The designated system administrator can access specific programs and modify some functions to better manage the OfficeServ 100, OfficeServ 500, OfficeServ 7000 Series office telephone systems. Instructions are detailed and easy to follow. When assistance is needed, contact your installation and service company.

# SPECIAL FEATURES

## SYSTEM RING PLANS

Your system is designed to have a maximum of six different Ring Plans. Each ring plan can be programmed to allow different lines to ring different ring plans to ring different station and/or station groups. Examples of why different ring plans are required can include normal day operation, night operation, using different operators during different lunch shifts and Saturday or evening hours of operation. While the system is in a ring plan, each station will be limited to its individual Ring Plan class of service dialing restrictions. You can place the system in one of any six of these ring plans at any time. Ring Plans are available on an individual tenant basis and may be set automatically or manually. Automatic Ring Plans have an individual start time and will remain in that mode until the beginning of the next defined ring plan. If no automatic timer is set, you must change ring plans manually.

Any of these ring plans can be switched from one plan to another at any time by manually pressing a ring plan button. There are two ways to override the automatic ring plans; one is a temporary override until the next programmed start time, and the other is a permanent override until manually changed.

## MANUAL RING PLAN CHANGE

Press the **RTO** button plus the ring plan passcode (four digits) and the ring plan (1-6) you wish to set. The system will override all the automatic time tables and will remain in the set ring plan until manually changed. To manually change or cancel the ring plan time override and return ring plan operation to the system clock: press the **RTO** plus the ring plan passcode (four digits) and a "0" to cancel the ring plan time override and return to normal operation.

## TEMPORARY RING PLAN CHANGE

Press the **RP** button plus the ring plan passcode (four digits) and the ring plan (1-6) you wish to set. The system will remain in that ring plan until the next automatic start time for the next ring plan goes into effect.

**NOTE:** This button may also be assigned an extender of one of the six ring plans. Example: An **RP** button is given an extender of 3 (**RP3**) and the operation of this button is a push on/push off type of operation with the system always returning to ring plan 1 when the key is turned off. When the system is operating in ring plan 3, the **RP3** button will light steady red, and when off the light will also turn off.

## CALLING THE SYSTEM OPERATOR

Any station that dials **0** will ring its assigned operator. (If tenant service is used, each tenant may have a different operator or operator group.) Calls to the system or tenant operator are easily identified because the **CALL** key will have a fast flashing red light. Station users will never receive a busy signal when they dial **0** or the operator group number. The calls will continue ringing in queue until answered.

**NETWORKING:** When 2 or more systems are networked a single station or operator group may receive all calls to a single operator. (Please consult with your service company if required).

## OPERATOR RECALLS

Transferred calls that go unanswered will recall to the station that originated the transfer. Should the station that originated the transfer not answer the recall, the call will be sent to the operator as a transfer recall.

A call left on hold will recall the station that put it on hold. If the hold recall is unanswered at the station that originated the hold, the call is sent to the operator.

Both types of recalls will ring and have a slow flashing amber light on the **LINE** key or **CALL** key.

**NETWORKING:** When 2 or more systems are networked a single station or operator group may receive all recalls to a single operator. (Please consult with your service company if required).

## EXECUTIVE BARGE-IN

If you want to break into another conversation, you must be allowed to barge-in and the other station and trunk must not be secure.

- Dial the desired extension or trunk number and listen for the busy signal.
- Press the **BARGE** button and begin speaking after the tone.
- Hang up when you are finished.

The system can be set for one of the three following barge-in options:

- No barge-in allowed
- Barge-in with intrusion tone
- Barge-in without intrusion tone (service observing)



When the second or third option is selected the barger will take priority over the line. This means unless you (barger) hang up first, the station or line you barged into will still be connected to you when the station you barged into hangs up. When the third option is selected, the station that barges-in can monitor the conversation and no warning tone or display will be sent to the station being monitored. The handset transmitter and keyset microphone are disabled. The party that originated the barge-in may join the conversation by pressing the **MUTE** button on the keyset. Your service company must program these options for you.

### WARNING

Barge-in without tone may violate state or federal laws concerning the right to privacy. Samsung Telecommunications America is in no way responsible for the possible misuse of this feature.

## WALKING CLASS OF SERVICE

You can change a restricted station's class of service to the same class as your station, allowing you to make calls or use features that would otherwise be restricted from that station.

- Lift the handset or press the **SPK** or the **MONITOR** key.
- Dial **59** and then your extension number.
- Dial your station passcode and receive internal dial tone.
- Dial an access code and then the telephone number—**OR**—use the desired feature as usual.
- Hang up. The station will be returned to its restricted status.

NOTE: The default station passcode 1234 cannot be used.

## IN/OUT OF GROUP

Any station assigned to a station group can remove itself from that group and then reenter the group at a later time. When out of the group, a station can receive calls to its extension number but not to the group.

The number of groups available to choose from may vary depending on your OfficeServ 100 or OfficeServ 500 or OfficeServ 7000 Series system type:

**OfficeServ 500 & OfficeServ 7200** 40 Groups  
(500 through 539) or (5000 through 5039 depending if your system is setup for 4 digits numbering plan)

**OfficeServ 500 L & OfficeServ 7400** 80 Groups  
(500 through 579) or (5000 though 5079 depending if your system is setup for 4 digits numbering plan)

**OfficeServ 100 & OfficeServ 7100** 20 Groups  
(500 through 519) these can be changed to 4 digits if required.

To create a backup or relief operator position, assign the main operator and one or more backup individuals to the operator group. All but the main operator should be out of the group. When it is necessary to use a backup operator, put the desired backup station in the group and remove the main operator. When incoming call traffic is heavy, you can have another station put itself in the operator group along with the main operator to handle the extra call load.

If the station does not have an **IN/OUT** key:

- Lift the handset and dial the feature access code \_\_\_\_\_.
- Dial the group number.
- Dial **0** to be out of the group or dial **1** to be in the group.
- Receive confirmation tone and hang up.

If the station has an **IN/OUT** key:

- Press the **IN/OUT** key. It will light red when the station is in the group.
- Press the **IN/OUT** key again. The light is off when the station is out of the group.

NOTE: A station can be in more than one group.

## DIRECT INWARD SYSTEM ACCESS (DISA)

From outside of the office, selected individuals can call into the OfficeServ 100 or OfficeServ 500 or OfficeServ 7000 Series system on special DISA line(s). A security code must be entered to gain access. Once these individuals are in the system, they can make outside calls using the office lines or call stations within the system. Individuals who will use DISA must have their stations assigned for DISA access and must change their station passcodes. The default passcode 1234 cannot be used.

- Call in on the DISA line from any phone with tone dialing.
- You will hear a dial tone. Dial your security code (your extension number plus your station passcode).
- If you are allowed access, you will receive a dial tone.
- Dial any line access code, receive outside dial tone and then dial a telephone number **OR** dial any extension number to call a station in the system.
- To make another call, press **Q**, receive dial tone and dial another number.
- Press **#** and hang up when finished.

NOTE: Outgoing DISA calls are controlled by the dialing class of the station identified by the security code. The DISA line must have disconnect supervision from the central office. Insist that this service is verified by your installation/service company.

## DISA SECURITY

A common practice among hackers is to repeatedly dial a known DISA access number (usually with a computer) and try a different passcode each time. The hacker hopes to eventually chance upon the correct passcode and thus gain access to your system. The OfficeServ 100, OfficeServ 500, and OfficeServ 7000 Series security feature counts the number of sequential incorrect passcode attempts. If a certain number is reached, DISA is disabled and the system sends an alarm to designated display stations. The number of passcode attempts and the disable duration are both programmable. In addition, the OfficeServ 100, OfficeServ 500, and OfficeServ 7000 systems will print an SMDR record (a customer-provided printer is required) each time an incorrect passcode is entered.

The DISA alarm will ring for a programmable time before canceling the ringing; however, the DISA alarm display will remain until the alarm is cleared. To clear the DISA alarm, follow the following procedure:

- Lift the handset and dial **58**.
- Enter the DISA alarm passcode (see your service company).
- Replace the handset.

### WARNING

As it is impossible to prevent unauthorized access to your telephone system by hackers, we suggest that you do not turn the DISA feature on unless you intend to use it. If you do use this feature, it is good practice to frequently change passcodes and periodically review your telephone records for unauthorized use.

## FORCED ACCOUNT CODES

### VERIFIED

When set for this option the user must enter an account code for all outgoing calls. The account code entered will be verified from a system list. Forced verified codes can contain the digits 0~9.

**OfficeServ 500 & 7100** 999 entries  
**OfficeServ 100** 500 entries  
**OfficeServ 7200 & 7400** 999 entries

### NOT VERIFIED

When set for this option the user must enter an account code for all outgoing calls, but the account code is not verified against the system list. Non verified account codes can contain the digits 0~9 and #.

## USING FORCED ACCOUNT CODES

When enabled, your system allows calls to be charged to different accounts. You can enter account codes either by dialing the full code, by entering an account code "bin number", or by pressing your **ACC** key if one is assigned. Bin numbers are a 3 digit short code that will automatically insert the appropriate account code. Account codes may be a maximum of 12 digits (# may be used); if the account code is to be less than 12 characters you may end the code by pressing **\*** or the right soft key. The type of code used is determined by your telephone system administrator. Codes can be entered before or during a call as follows:

### To enter an account code before placing the call:

- Press your **ACC** key or dial **47**.
- Dial the account code or bin number.
- You will receive a confirmation tone and display.
- When prompted dial a trunk or trunk group (i.e. 9) and the telephone number to call.

### To enter an account code by interrupting the conversation:

- While on an outside call press the **ACC** key or press **TRANSFER** followed by **47**.
- Dial the account number or bin number (if you are entering an account code you will need to press your **ACC** key or right soft key to finalize the entry)

NOTE: If you make an error simply repeat the procedure with the correct code. Only the most recent account code dialed will be recorded. This code will always print on SMDR reports. For information on entering and changing forced account codes, see the system administrator programming section of this book.

## AUTHORIZATION CODES

Authorization codes are used to validate a station user and give permission to make a call. These four digit authorization codes can be either forced or optional, but if used, are always verified from a system list of **500** entries on the **OfficeServ 500 M or L** version, the **OfficeServ 7100**, **OfficeServ 7200** and **OfficeServ 7400**, **250** entries on the **OfficeServ 100**. Each authorization code has an associated class of service. When the code is entered, the class of service is changed to that of the authorization code.

## USING AUTHORIZATION CODES

After going off-hook, the station user must dial \* followed by a four digit authorization code. If you enter a correct code, you will hear confirmation tone and then receive a dial tone and you can make an outside call in the usual manner. The station then follows the dialing class for that authorization code. If you enter an incorrect code, the station returns error tone. This code may or may not print on SMDR reports depending on SMDR programming.

## USING THE TIE LINE

### OUTGOING

Your office can be connected to another system with a tie line. Use this line to make calls to stations in the other system. If programming allows, you can access lines in the other system to make outside calls. Tie line calls can be put on hold, transferred and conferenced in the same manner as are other outside calls.

- Lift the handset or press the **SPK** or **MONITOR** key.
- Dial the tie line access code or press the tie line key.
- When you receive dial tone from the other system, you can dial extension numbers or access outside lines. You must know the extension numbers and the line access codes for the other system.
- Finish the call by replacing the handset or pressing the **ANS/RLS** or the **MONITOR** key if you are using a 7 button phone.

NOTE: Outgoing calls are controlled by the station's dialing class.

### INCOMING

Station users in the other system can access the tie line and make intercom calls to stations in your system. Answer tie line calls ringing at your station as you would any other outside call. They can be put on hold, transferred and conferenced in the same manner as are other outside calls.

### IN AND OUT ON TIE LINE [NOT SUPPORTED ON OS 7100]

Users accessing the tie line from the other system can get a line in your system and make outgoing calls. These calls can be controlled by assigning a dialing class to the tie line. For further information, see your service company.

## CALLER ID SPECIAL FEATURES

**NOTE: The Caller ID features below require optional software and/or hardware. Please ask your installation and service company for details.**

## ABANDON CALL LIST

The system has a system-wide abandoned calls list that stores CID information for the last **100** calls on the **OfficeServ 7000 Series, OfficeServ 500 M and L** version and **50** calls on the **OfficeServ 100** that rang but were not answered and were accompanied with valid CID information. Calls with CID information consisting of OUT OF AREA, PAYPHONE or PRIVATE will not be stored in the list. The abandoned calls list is accessed using the system administrator's passcode. When reviewing this list, you are provided options to **CLEAR** the entry or **DIAL** the number. You can use the **NND** key to toggle between the CID name, CID number and the date and time the call came in. The system must be using LCR to dial numbers from the abandoned calls list.

To view the list of abandoned incoming calls for which CID information has been received:

- Dial **64** and dial the system administrator passcode.
- Scroll through the entries using the **VOL** keys.

## CID ON SMDR

The Station Message Detail Records (SMDR) report can be set to include the CID name and number for incoming calls. This format expands the printout to 113 characters. You must use a wide carriage printer or an 80 column printer set to the condensed print option.

## NUMBER TO NAME TRANSLATION

The system provides a translation table of **1000** entries in the **OfficeServ 7100, 7200** and **OfficeServ 500 M**, and **2000** entries in the **OfficeServ 500 L** and in the **OfficeServ 7400**, and **500** entries on the **OfficeServ 100** for use in areas that do not provide name and number (sometimes called "deluxe") Caller ID or when ANI is received. When the CID or ANI number is received, the table is searched. When a match is found, the system will display the corresponding name from the table. This will allow users in areas that do not support "deluxe" Caller ID or have only ANI service to provide names for callers.

# CALLER ID SPECIAL FEATURES

## INVESTIGATE [ISPY]

Investigate allows selected stations with a special class of service to investigate any call in progress. If CID information is available for an incoming call, you will know to whom this station user is speaking. For outgoing calls, you can see the number that was dialed. After investigating, you may barge-in on the conversation, disconnect the call or hang up your phone to end the investigation.

- At *your* keyset, press the **INVESTIGATE [ISPY]** key.
  - Enter your station passcode. (Default passcodes cannot be used.)
  - Enter the station number to be investigated.
  - You can now press **BARGE** to barge-in on the conversation.
- OR**  
You can press **NND** to view more information about the call.
- OR**  
You can press **DROP** to disconnect the call.

### NOTES:

1. If the call is an outgoing call, the **NND** key will not appear.
2. This feature requires optional software and/or hardware. Please ask your installation and service company for details.

### WARNING

This feature may violate state or federal laws concerning the right to privacy. Samsung Telecommunications America is in no way responsible for the possible misuse of this feature.

**NOTE:** This information is NOT repeated in this user guide.

# SYSTEM ADMINISTRATOR PROGRAMMING

## CUSTOMER LEVEL ACCESS

Before any customer programs can be accessed, you must first open system programming using the passcode you have been assigned. You must use a display keyset. Should it become necessary to change this passcode, see your service company.

- While on-hook, press **TRSF** and then dial **200**.  
Your display shows [ENABLE CUS. PROG. PASSCODE].
- Dial the four digit passcode.  
The display shows [ENABLE CUS. PROG. - DISABLE].
- Dial **1** to enable. The display shows [ENABLE CUS. PROG - ENABLE].
- Press **TRSF**. The keyset returns to its idle condition.
- Press **TRSF** and then dial the three digit program code you want to access. Follow the instructions for that program.

**NOTE:** You must begin programming within 30 seconds. Once you are in programming, any delay of more than 30 seconds between key strokes will cause the system to automatically close programming.

## CUSTOMER LEVEL ACCESS USING THE PROG KEY

A designated keyset may be programmed with a "**PROG**" key which allows access to the following areas of system programming. When pressed you must enter your station passcode followed by the MMC number. The default station passcode "1234" can not be used. The only MMCs that may entered from pressing the "**PROG**" key are as follows:

- [MMC 100 Station Lock for All Stations](#)
- [MMC 102 Station Forward for All Stations](#)
- [MMC 104 Station Name](#)
- [MMC 115 Program Message for all Stations](#)
- [MMC 116 Alarm and Message](#)
- [MMC 505 System Day and Time](#)
- [MMC 705 System Speed Dial](#)
- [MMC 706 System Speed Dial Name](#)

## CHANGING FEATURE PASSCODE

You can change individual feature passcodes. This program is used to change the passcodes for several features. These features are the following: RING PLAN SERVICE, DISA ALARM, ALARM CLEAR, and AA RECORD. Note: Each passcode is four digits long. Each digit can be 0 to 9.

### PROGRAM KEYS

**UP & DOWN** - Select the extension number.

**HOLD** - Press to reset the passcode to default settings.

Open customer programming and follow the instructions below.

### ACTION

1. Press **TRSF** and then dial **202**  
Display shows
2. Use the **UP** and **DOWN** keys to scroll through the different options and press the right soft keys.
3. Press **HOLD** to reset the passcode
4. Press **TRSF** to store and exit programming OR press **SPK** to store and advance to the next program

### DISPLAY

CHANGE PASSCODE  
RING PLAN: 0000

CHANGE PASSCODE  
DISA ALARM: 5678

CHANGE PASSCODE  
RING PLAN: 0000

## SET DATE AND TIME DISPLAY

Should it ever become necessary to correct the date and time displayed on all of the keysets, do so as soon as you notice that they are incorrect. Automatic Operating Mode will not work correctly and SMDR records will be of no value when the date and time are not correct.

The display format is the following:

W (Day of the week): Enter **0** for Sunday and **6** for Saturday.

MM (Month): Enter **01** for January and **12** for December.

DD (Day of the month): Enter a number in the range of **01–31**.

YY (Year): Enter the last two digits of the year.

HH (Hours): Use the 24 hour clock and enter a number in the range of **00–24**.

MM (Minutes): Enter a number in the range of **00–59**.

Failure to enter the time using the 24 hour clock will cause the date to change at 12:00 P.M. Open customer programming and follow the instructions below.

### ACTION

1. Press **TRSF** and then dial **505**  
Display shows
2. Enter the new time and date using the above format
3. Verify the time and date and reenter them if necessary
4. Press **TRSF** to store and exit programming OR press **SPK** to store and advance to the next program

### DISPLAY

OLD: 6010184:0047  
NEW: WMMDDYY: HHMM

OLD: 6010184:0047  
NEW: 3020994:1445

OLD: 3020994:1445  
NEW: WMMDDYY: HHMM

If you have entered invalid data, you will receive an [ INVALID ENTRY ] message for three seconds. Reenter the correct date and time. If the information you entered is incorrect, repeat the procedure.

## RESET STATION PASSCODES TO DEFAULT

Individual keyset users can set or change their own individual passcodes. These passcodes are used to lock and unlock keysets, override toll restriction and access the DISA feature. At times, it may be necessary for the system administrator to reset a station's passcode to default "1234." This program cannot be used to display passcodes, only to reset them.

### PROGRAM KEYS

**UP & DOWN** - Select the extension number.

**HOLD** - Press to reset the passcode.

Open customer programming and follow the instructions below.

### ACTION

1. Press **TRSF** and then dial **101**  
Display shows

### DISPLAY

[ 20 ] PASSCODE  
PASSCODE: \*\*\*\*

2. Dial the station number OR use the **UP** and **DOWN** keys to scroll through the keyset numbers and press the right soft key to move the cursor right

[ 205 ] PASSCODE  
PASSCODE: \*\*\*\*

3. Press **HOLD** to reset the passcode

[ 205 ] PASSCODE  
PASSCODE : 1234

4. Press the right soft key to return to step 2 OR press **TRSF** to store and exit programming OR press **SPK** to store and advance to the next program

**DEFAULT DATA: ALL STATION PASSCODES = 1234**

## PROGRAM STATION NAMES

This program is used to assign a character name or identification for each extension. You may assign a name of 11 characters long.

### PROGRAM KEYS

**UP & DOWN** - Used to scroll and move cursor.

**KEYPAD** - Used to enter characters.

**HOLD** - Press to clear entry.

Open customer programming and follow the instructions below.

### ACTION

1. Press **TRSF** and then dial **104**  
Display shows
2. Dial station number (e.g., **205**)  
OR press **UP** or **DOWN** to select the station and press the right soft key to move the cursor
3. Enter the station name using the procedure described on the next page and press the right soft key to return to step 2

### DISPLAY

[ 201 ] STN NAME

[ 205 ] STN NAME

[ 205 ] STN NAME  
SAM SMITH

4. Press **TRSF** to store and exit programming OR press **SPK** to store and advance to the next program

NOTE: Directory information is always 11 characters.

### DEFAULT DATA: NONE

Names are written using the keypad. Each press of a key will select a character. Pressing the dial pad key moves the cursor to the next position. For example, if the directory name is "SAM SMITH," press the number "7" three times to get the letter "S." Press the number "2" once to get the letter "A." Continue selecting characters from the table below to complete your message. Press the "A" key to change the letter from upper case to lower case.

### NOTES:

1. When the character you want appears on the same dial pad key as does the previous character, press the **UP** key to move the cursor to the right.
2. When the system is equipped with a Samsung Voicemail system, and the option has been enabled, changes to station names will automatically change the voicemail box name if a voicemail box exists.

### DCS KEYSETS [NOT SUPPORTED ON THE OFFICESERV 7100]

COUNT	1	2	3	4	5
DIAL 0	Q	Z	.	)	0
DIAL 1	space	?	,	!	1
DIAL 2	A	B	C	@	2
DIAL 3	D	E	F	#	3
DIAL 4	G	H	I	\$	4
DIAL 5	J	K	L	%	5
DIAL 6	M	N	O	^	6
DIAL 7	P	R	S	&	7
DIAL 8	T	U	V	Q	8
DIAL 9	W	X	Y	(	9
DIAL *	:	=	[	]	*

The # key can be used for the following special characters: #, space, &, !, :, ;, ., %, \$, -, /, =, [, ], @, ^, (, ), \_ , +, {, }, |, ;, \, " and ~.

## iDCS / ITP / SMT-i / DS 5000 KEYSETS

COUNT	1	2	3	4	5
DIAL 0	<	>	.	)	0
DIAL 1	space	?	,	!	1
DIAL 2	A	B	C	@	2
DIAL 3	D	E	F	#	3
DIAL 4	G	H	I	\$	4
DIAL 5	J	K	L	%	5
DIAL 6	M	N	O	^	6
DIAL 7	P	Q	R	S	7
DIAL 8	T	U	V	*	8
DIAL 9	W	X	Y	Z	9
DIAL *	:	=	[	]	*

1. When the character you want appears on the same dial pad key as the previous character, press UP to move the cursor one space to the right.
2. Other symbols are available for DIAL #.

## PROGRAM TRUNK NAMES

This program is used to assign a character name or identification for each C.O. line. You may assign a name of 11 characters long.

### PROGRAM KEYS

**UP & DOWN** - Used to scroll and move cursor.

**KEYPAD** - Used to enter characters.

**HOLD** - Press to clear entry.

Open customer programming and follow the instructions below.

### ACTION

1. Press **TRSF** and then dial **404**  
Display shows
2. Dial trunk (e.g., **704**) OR press **UP** or **DOWN** to select trunk and press the right soft key to move the cursor
3. Enter the trunk name using the procedure in [Program Station Names](#) and press the right soft key to return to step 2
4. Press **TRSF** to store and exit programming OR press **SPK** to store and advance to the next program

### DISPLAY

[ 701 ] TRUNK NAME

[ 704 ] TRUNK NAME

[ 704 ] TRUNK NAME  
SAMSUNG

## PROGRAM STATION GROUP NAMES

This program is used to assign a character name or identification for each station group. You may assign a name 11 characters long.

### PROGRAM KEYS

**UP & DOWN** - Used to scroll and move cursor.

**KEYPAD** - Used to enter characters.

**HOLD** - Press to clear entry.

Open customer programming and follow the instructions below.

### ACTION

1. Press **TRSF** and then dial **602**  
Display shows the first group
2. Dial the group number (e.g., **505**) OR press the **UP** or **DOWN** key to make a selection and press the left or right soft key to move the cursor
3. Enter the name using the method in [Program Station Names](#)
4. Press the left or right soft key to return to step 2 OR press **TRSF** to store and exit programming OR press **SPK** to store and advance to the next program

### DISPLAY

[ 501 ] SGR NAME

[ 505 ] SGR NAME

[ 505 ] SGR NAME  
SAMSUNG

## PROGRAM SYSTEM SPEED DIAL NUMBERS

The system list starts with 200 numbers and can be increased in blocks of ten. The system may have either 500 or 950 maximum depending on the setting in MMC 861. See your service company to increase or decrease the system list.

The speed dial codes are 500–999 or 050–999. Each speed dial number consists of a line access code and the telephone number to be dialed. The access code can be any line group, individual line, station group or individual extension. The speed dial number can be up to 24 characters long including **\***, **#**, **FLASH** and **PAUSE**.

NOTE: If Least Cost Routing (LCR) is being used, the LCR access code must be entered.

When you are entering a speed dial number, there are some special keys that you will need to use. These are the bottom row of programmable keys on the keysets and are known as keys **A**, **B**, **C**, **D**, **E** and **F**.

### PROGRAM KEYS

**UP & DOWN** - Select the speed dial bin.

**KEYPAD** - Used to enter number.

**HOLD** - Press to clear entry.

**SPK/RLS** - Save data and advance to next program.

**A** - Does not have a function.

**B** - Inserts a FLASH.

**C** - Inserts a PAUSE.

**D** - Changes the dialing type from pulse to tone.

**E** - Hides and displays digits.

**F** - Changes display to speed dial name or number entry.

### DCS KEYSETS [NOT SUPPORTED ON OFFICESERV 7100]

12 BUTTON KEYSET  
PROGRAMMABLE KEYS LAYOUT

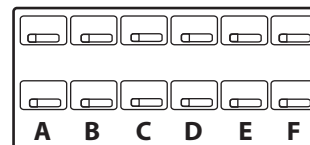

24 BUTTON KEYSET  
PROGRAMMABLE KEYS LAYOUT

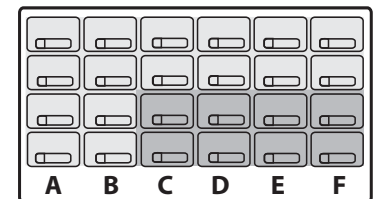



**iDCS KEYSETS**

**8D KEYSET PROGRAMMABLE KEYS LAYOUT**

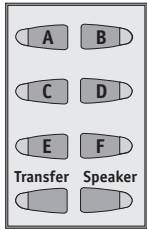

**28D KEYSET, 18D KEYSET PROGRAMMABLE KEYS LAYOUT**

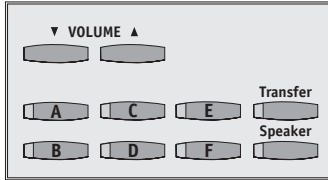

**DS 5000 SERIES KEYSETS**

**75 KEYSET PROGRAMMABLE KEYS LAYOUT**

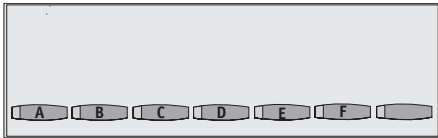

**14D KEYSET PROGRAMMABLE KEYS LAYOUT**

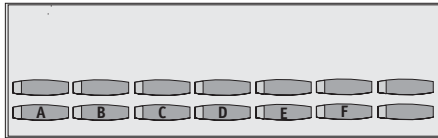

**21D KEYSET PROGRAMMABLE KEYS LAYOUT**

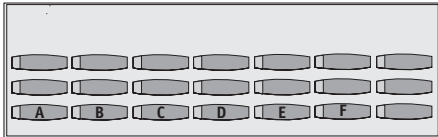

**SMT-i SERIES KEYSETS**

**SMT-i3105**



**SMT-i5210**



**SMT-i5220**



**SMT-i5230**



**SMT-i5243**



Open customer programming and follow the instructions below.

### ACTION

1. Press **TRSF** and then dial **705**  
Display shows the first number
2. Dial the speed bin desired (e.g., **505**) OR press **UP** or **DOWN** to choose and press the right soft key to move the cursor
3. Enter the access code (e.g., **9**—the system will automatically insert a dash) followed by the phone number (up to 24 digits long) and press the right soft key to return to step 2
4. Press the **F** key to toggle to [Program System Speed Dial Names](#), step 3 to enter the name
5. Press **TRSF** to store and exit programming OR press **SPK** to store and advance to the next program

### DISPLAY

SYS SPEED DIAL  
500:

SYS SPEED DIAL  
505:

SYS SPEED DIAL  
505:9-121223456789

SYS SPEED NAME  
505:

### DEFAULT DATA: NO SPEED NUMBERS ASSIGNED

## PROGRAM SYSTEM SPEED DIAL NAMES

This program is used to assign a character name or identification for each system speed dial location. This name enables you to locate the speed dial number when you are using the directory dial feature. You may assign a name 11 characters long.

### PROGRAM KEYS

**UP & DOWN** - Used to scroll through speed dial bins.

**KEYPAD** - Used to enter selections.

**SOFT KEYS** - Move cursor left and right.

**SPK** - Used to store data and advance to next program.

**HOLD** - Used to clear previous entry.

### ACTION

1. Press **TRSF** and then **706**  
Display shows the first name
2. Dial the system speed number (e.g., **505**) OR press **UP** or **DOWN** to select the entry number and press the right soft key to move the cursor
3. Enter the name as shown in *Program Station Names* and press the right soft key to return to step 2 OR press the **F** key to toggle to the speed dial number to return to [Program System Speed Dial Numbers](#), step 4
4. Press the right soft key to return to step 2 above OR press **TRSF** to store and exit programming OR press **SPK** to store and advance to the next program

### DISPLAY

SYS SPEED NAME  
500:

SYS SPEED NAME  
505:

SYS SPEED NAME  
505:SAMSUNG

# PROGRAM PERSONAL SPEED DIAL NUMBERS FOR OTHER STATIONS

Individual station users can program their own numbers, but in cases where this is not practical, or for single line telephone users, this program allows a system administrator to view or change any station's speed dial numbers. The station speed dial codes are 00–49 or 000–049. Each station begins with ten numbers (00–09) and can be assigned more in blocks of ten (up to a maximum of fifty numbers).

Each speed dial number consists of a line access code and the telephone number to be dialed. The access code can be any line group, individual line, station group or individual extension. The speed dial number can be up to 24 characters long including \*, #, **FLASH** and **PAUSE**.

NOTE: If Least Cost Routing (LCR) is used, the LCR access code must be entered.

When you are entering a speed dial number, there are some special keys that you will need to use. These are the bottom row of programmable keys on the LCD 12B and LCD 24B keysets and are known as keys **A**, **B**, **C**, **D**, **E** and **F**.

## PROGRAM KEYS

**UP & DOWN** - Scrolls through extension numbers and speed dial bins.

**KEYPAD** - Used to enter number.

**HOLD** - Press to clear entry.

**A** - Does not have a function.

**B** - Inserts a FLASH.

**C** - Inserts a PAUSE.

**D** - Changes the dialing type from pulse to tone.

**E** - Hides and displays digits.

**F** - Changes display to speed dial name or number entry.

[Refer to Programmable Keys Layout in the Program System Speed Dial Numbers.](#)

Open customer programming and follow the instructions below.

## ACTION

1. Press **TRSF** and then dial **105**  
Display shows
2. Dial the station number (e.g., **205**) OR press **UP** or **DOWN** to select the station and press the right soft key to move the cursor OR press the left soft key to go to step 4
3. If the selected station has no speed dial bins, this display will be shown and a new station may be selected
4. Dial the location number (e.g., **05**) OR press **UP** or **DOWN** to select the location and press the right soft key to move the cursor OR press the left soft key to return to step 2
5. Enter the trunk access code (e.g., **9**) followed by the number to be dialed (e.g., **4264100**) OR press the right soft key to return to step 2 OR press the left soft key to return to step 3 OR press **HOLD** to clear an entry (if an error is made, use the **DOWN** key to step back)
6. Press the **F** key to access [Program Station Speed Dial Names](#) OR press **TRSF** to save and exit programming OR press **SPK** to save and advance to the next program

## DISPLAY

```
[ 201 ] SPEED DIAL  
00 :
```

```
[ 205 ] SPEED DIAL  
00 :
```

```
[ 205 ] SPEED DIAL  
SPDBLK NOT EXIST
```

```
[ 205 ] SPEED DIAL  
05 : _
```

```
[ 205 ] SPEED DIAL  
05 : 9-4264100_
```

**DEFAULT DATA: NO SPEED DIAL NUMBERS PROGRAMMED**

## PROGRAM PERSONAL SPEED DIAL NAMES FOR OTHER STATIONS

Each individual station user can program his/her own names but in cases where it is impractical or for single line telephone users, this program allows a system administrator to view or change any station's speed dial names. The station speed dial codes are 00–49. Each station begins with ten numbers (00–09) and can be assigned more in blocks of ten up to a maximum of fifty numbers.

### PROGRAM KEYS

**UP & DOWN** - Used to scroll through extension numbers and speed dial bins.

**KEYPAD** - Used to enter selections.

**SOFT KEYS** - Move cursor left and right.

**SPK** - Used to store data and advance to next program.

**HOLD** - Used to clear previous entry.

**ANS/RLS** - Used to select ALL.

### ACTION

1. Press **TRSF** and then dial **106**  
Display shows
2. Dial the station number (e.g., **205**) OR press **UP** or **DOWN** to select the station and press the right soft key to move the cursor
3. If the selected station has no speed dial bins, this display will be shown and a new station may be selected
4. Dial the speed dial location (e.g., **05**) OR use **UP** or **DOWN** to scroll through the location numbers and use the right soft key to move the cursor OR press the left soft key to return to step 2 above

### DISPLAY

```
[ 201 ] SPEED NAME
00:
```

```
[ 205 ] SPEED NAME
00:
```

```
[ 205 ] SPEED DIAL
SPDBLK NOT EXIST
```

```
[ 205 ] SPEED NAME
01: _
```

5. Enter the name using the procedure in [Program Station Names](#) and press the right soft key to return to step 2 OR press the left soft key to return to step 3
6. Press the **F** key to access *Program Personal Speed Dial Numbers for Other Stations* OR press **TRSF** to store and exit programming OR press **SPK** to store and advance to the next program

```
[ 205 ] SPEED NAME
01: SAM SMITH
```

## CREATE PROGRAMMED STATION MESSAGES

The programmed station message feature lets you set a message at your phone to notify users with Display Phones that you may be out of town. This way, when Display Phone users call their display will show "OUT OF TOWN" and they will know why you do not answer.

The OfficeServ 100, OfficeServ 500, and OfficeServ 7000 systems allow 15 messages to be programmed in the system list in MMC 715 and each station can program 5 messages individually.

### PROGRAM KEYS

**UP & DOWN** - Select the message number.

**KEYPAD** - Used to enter characters.

**HOLD** - Press to clear entry.

Open customer programming and follow the instructions below.

### ACTION

1. Press **TRSF** and then dial **715**  
Display shows the first message
2. Dial in the message number (e.g., **11**) OR press **UP** or **DOWN** to scroll through the messages and press the right soft key to move the cursor

### DISPLAY

```
PGM.MESSAGE (01)
GIVE ME THE CALL
```

```
PGM.MESSAGE (16)
EMPTY MESSAGE
```

3. Enter in the message using the procedure in [Program Station Names](#) and press the right soft key to return to step 2 above

PGM.MESSAGE (16)  
IN THE SHOWROOM

4. Press **TRSF** to store and exit programming OR press **SPK** to store and advance to the next program

## SET ALARM/APPOINTMENT REMINDER WITH MESSAGE

Keypad users can set their own alarms but standard telephone users cannot. The system administrator can set alarm/appointment reminders for other stations in the system.

### PROGRAM KEYS

**UP & DOWN** - Scroll through extensions.

**HOLD** - Press to clear data.

**KEYPAD** - Used to enter data.

Open customer programming and follow the instructions below.

### ACTION

1. Press **TRSF** and then dial **116**  
Display shows
2. Dial the station number (e.g., **205**) OR press **UP** or **DOWN** to select the station and press the right soft key to move the cursor OR press **ANS/RLS** to select all stations
3. Dial **1-3** to select the alarm (e.g., **2**) OR press **UP** or **DOWN** to select the alarm and press the right soft key to move the cursor OR press the left soft key to return to step 2
4. Enter the alarm time in 24 hour clock format (e.g., **1300**) and the display will automatically advance to step 5

### DISPLAY

[ 201 ]ALM REM (1)  
HHMM: NOTSET

[ 205 ]ALM REM (1)  
HHMM: NOTSET  
OR

[ ALL ]ALM REM (1)  
HHMM: NOTSET

[ 201 ]ALM REM (1)  
HHMM: NOTSET

[ 205 ]ALM REM (2)  
HHMM: 1300NOTSET

5. Enter the alarm type from the list above OR press **UP** or **DOWN** to select the alarm type and press the right soft key to move the cursor

[ 205 ]ALM REM (2)  
HHMM: 1300DAILY

6. Enter the messages using the procedure in [Program Station Names](#) and press the right soft key to return to step 2

[ 205 ]ALM REM (2)  
TAKE MEDICATION

7. Press **TRSF** to store and exit programming OR press **SPK** to store and advance to the next program

## MANAGING KEY ASSIGNMENTS

You can view station key assignments and add extenders to some of the programmable keys for easy one touch operation of frequently used features.

An extender is a number that makes an otherwise general key very specific. Adding the digit "4" to a **PAGE** key defines this key for paging zone four. Adding "225" to a directed pickup key will define this key as pickup for extension 225 only. The key must already be assigned by the installing technician.

This program is used to assign extenders. Some common keys that require extenders are:

KEY	DESCRIPTION	EXTENDER
<b>BOSS</b>	Boss/Secretary	(1-4)
<b>DP</b>	Direct Pickup	(Extension number or station group number)
<b>DS</b>	Direct Station	(Any extension number)
<b>FWRD</b>	Call Forwarding	(0-7)
<b>GPIK</b>	Group Pick-Up	(01-20)
<b>IG</b>	In/Out of Group	(Any group number you are part of)
<b>MMPG</b>	Meet Me Page	(0-9, *)
<b>PAGE</b>	Page	(0-9, *)
<b>PARK</b>	Park (orbits)	(0-9)
<b>RP</b>	Ring Plan	(1-6), HOLD for none
<b>SPD</b>	Speed Dialing	(00-49, 500-999)
<b>PMSG</b>	Programmed Messages	(01-30) [Only 20 on the OS7100]
<b>DIR</b>	Directory	PERS (1), SYS (2) or STN (3)
<b>VT</b>	Voice Mail Transfer	Voice Mail Group Number

**SG**.....Station Group .....**501–509** for the OfficeServ 7030  
**501–519** for the OfficeServ 100,  
OfficeServ 7100, OfficeServ 7200-S  
**501–539** for the OfficeServ 500 M  
**501–579** for the OfficeServ 500 L  
**501–539** for the OfficeServ 7200  
**501–579** for the OfficeServ 7400

**PROGRAM KEYS**

**UP & DOWN** - Select the extension number.  
**KEYPAD** - Used to enter extender codes.  
**HOLD** - Used to clear the displayed data.

Open customer programming and follow the instructions below.

<b>ACTION</b>	<b>DISPLAY</b>
1. Press <b>TRSF</b> and then dial <b>107</b> Display shows the first station	[ 201 ] KEY EXTEND 01 : CALL1
2. Dial the station number (e.g., <b>205</b> ) OR use UP or DOWN to scroll through the station numbers and press the right soft key to move the cursor	[ 205 ] KEY EXTEND 01 : CALL1
3. Enter the key number (e.g., <b>18</b> ) OR use <b>UP</b> and <b>DOWN</b> to scroll through the keys and use the right soft key to move the cursor OR press the key to be programmed	[ 205 ] KEY EXTEND 18 : DS
4. Dial the extender according to the list above and the system will display your selection If there are no more entries, press the left soft key to return to step 2	
5. Press <b>TRSF</b> to store and exit programming OR press <b>SPK</b> to store and advance to the next program	[ 205 ] KEY EXTEND 18 : DS207

## PROGRAMMING ACCOUNT CODES

This program is used to add or change account code entries.

**PROGRAM KEYS**

**KEYPAD** - Used to enter the account code (allowable digits 0–9).  
**UP & DOWN** - Used to select entry number.  
**FLASH & TRSF** - Used to view and change only the used entries.  
**SPK/RLS** - Used to clear data.

Open customer programming and follow the instructions below.

<b>ACTION</b>	<b>DISPLAY</b>
1. Press <b>TRSF</b> and then dial <b>708</b> Display shows	ACCOUNT CODE ( 001 )
2. Dial the account code entry (e.g., <b>005</b> ) OR press <b>UP</b> or <b>DOWN</b> to select the entry number and press the right soft key to move the cursor	ACCOUNT CODE ( 005 )
3. Enter the account code via the dial pad, e.g., <b>1234</b> (maximum of 12 digits) and press the right soft key to move the cursor back to step 2	ACCOUNT CODE ( 005 ) 123456789012
4. Press <b>TRSF</b> to store and exit pro- gramming OR press <b>SPK</b> to store and advance to the next program	

## STATION TIMERS

Each station can have five timers customized for them to accommodate station users with individual work habits. These timers are as follows:

### **NO ANS FWD** No Answer Forward

This is the amount of time a call will ring at a station before it forwards to the Forward No Answer destination. The default is 15 seconds and the range is 000 to 250 seconds. Make sure that this timer is not set to a greater value than the transfer recall timer or transferred calls will not forward.

### **DTMF DUR.** DTMF Duration

This is the duration of DTMF tones sent to an analog voice mail port. The default duration is 100 milliseconds and the range is 0100 to 9900 milliseconds.

### **F-DGT DELY** First Digit Delay

This is the time the system will wait before sending DTMF digits to a voice mail port. The default time is 600 milliseconds and the range is from 100 to 9900 milliseconds.

### **OFFHK SEL.** Off Hook Select

This timer controls the delay between going off hook (lifting the handset) and the off hook select destination being called. The default duration is 10 seconds and the range is from 000 to 250 seconds.

### **EFWD DELAY** External Forward Delay

This is the time that a station will ring before a call forwards to the external call forward destination. The default duration is 10 seconds and the range is 1 second to 250 seconds.

Open customer programming and follow the instructions below.

### PROGRAM KEYS

**KEYPAD** - Used to set timer values.

**UP & DOWN** - Used to select extension number.

**SPK/RLS** - Save data and advance to next program.

### ACTION

1. Press **TRSF** and then dial **502**  
Display shows

### DISPLAY

```
[201] NO ANS FWD  
010 SEC
```

2. Dial the station number (e.g., **205**) OR press **UP** or **DOWN** key to select the station and press the right soft key OR press **ANS/RLS** to select all stations and press the right soft key

```
[205] NO ANS FWD  
010 SEC  
OR
```

```
[ALL] NO ANS FWD  
010 SEC
```

3. Press **UP** or **DOWN** key to select the station timer and press the right soft key

```
[205] DTMF DUR.  
0100 MS→
```

4. Enter the new value via the dial pad, e.g., **0300** and the system will return to step 2

```
[205] DTMF DUR.  
0100 MS→0300
```

5. Press **TRSF** to store and exit programming OR press **SPK** to store and advance to the next program

## ADDING NAMES TO THE TRANSLATION TABLE

This program allows the system administrator or technician to associate a CID or ANI number received from the Central Office with a name programmed in this translation table. If there is no match between a received number and a name in this table, [no CID name] or [no ANI name] will be displayed.

The translation table consists of **1000** entries in the **OfficeServ 500 M** and **OfficeServ 7100**, and **OfficeServ 7200** and **OfficeServ 7400** systems or **2000** entries in the **OfficeServ 500 L** system or **500** entries in the **OfficeServ 100** system with each entry comprised of a ten digit telephone number and a 16 digit name. [See Program Station Names.](#)

Open customer programming and follow the instructions below.

### PROGRAM KEYS

**UP & DOWN** - Used to scroll through options.

**KEYPAD** - Used to enter selections.

**SOFT KEYS** - Move cursor left and right.

**SPK** - Used to store data and advance to next MMC.

**HOLD** - Used to clear previous entry.

## ACTION

1. Press **TRSF** and then dial **728**  
Display shows first entry
2. Dial entry number (e.g., **005** or **0005**)  
OR use **UP** and **DOWN** to scroll through entries and press right soft key to select entry
3. Enter telephone number and press right soft key to advance to name entry  
OR enter telephone number and press left soft key to return to step 2 above
4. Enter the name using the method in [Program Station Names](#) and press right or left soft key to return to step 2 above  
OR press **SPK** to save and advance to next MMC OR press **TRSF** to save and exit programming

**DEFAULT DATA: NONE**

## DISPLAY

TRANSLATION: (001)  
DIGIT: \_

TRANSLATION: (005)  
DIGIT: \_

TRANSLATION: (005)  
DIGIT: 3054264100

TRANSLATION: (005)  
SAMSUNG TELECOM

## HOLIDAY

This program provides the ability to set as many as 20 different holidays. Each holiday will override the System Operating Mode for that particular date with a programmed ring plan.

### PROGRAM KEYS

**UP & DOWN** - Used to scroll through options.

**KEYPAD** - Used to enter selections.

**SOFT KEYS** - Move cursor left and right.

**HOLD** - Used to clear an entry.

## ACTION

1. Press **TRSF** and then dial **512**  
Display shows Holiday 1
2. Press the **RIGHT** soft key to advance cursor.  
Press **UP** or **DOWN** key to select a month.  
or use the dial pad to enter a **month** number (e.g., 12).
3. Press **UP** or **DOWN** key to select a day and press **RIGHT** soft key to advance cursor  
or use the dial pad to enter a **day** number.
4. Press **UP** or **DOWN** to select a ring plan and press **RIGHT** soft key to advance cursor  
or use the dial pad to enter a **ring plan** number (e.g., 4).
5. Press **UP** or **DOWN** key to select a voicemail ring mode and press **RIGHT** soft key to advance cursor or use the dial pad to enter a **ring mode** number (e.g., 15).
6. Press **TRSF** to store and exit programming OR press **SPK** to store and advance to the next program

## DISPLAY

:MM/DD :RP:VM  
01: / : :

:MM/DD :RP:VM  
01:\_ / : :

:MM/DD :RP:VM  
01:12/\_ : :

:MM/DD :RP:VM  
01:12/31 :\_ :

:MM/DD :RP:VM  
01:12/31 :4 :\_

:MM/DD :RP:VM  
01:12/31 :4 :15



# CUSTOMER SET RELOCATION

This program is used to swap information associated with two stations. All assignments such as trunk ring, station group, station COS, station speed dial etc. will follow this program. 18 button keysets and 28 button keysets can be exchanged. If incompatible set types are selected the system will provide an ERROR: NO MATCH message. 18 button and 28 button key assignments should be taken in consideration when relocating these type of sets. The table below shows which phones can be switched with each other.

NOTE: In order to use this program it must first be activated by a technician. Please see your installing company to have this done if you wish to use this program. Set Relocation does not apply to ITP/SMT-i Series phones.

## PROGRAM KEYS

**UP & DOWN** - Used to scroll through options.

**KEYPAD** - Used to enter selections.

**SOFT KEYS** - Move cursor left and right.

**SPK** - Used to store data and advance to next program.

**HOLD** - Used to clear previous entry.

**ANS/RLS** - Used to select ALL.

## ACTION

1. Press **TRSF 315**

Display shows

## DISPLAY

```
SET RELOCATION
EXT _ EXT
```

2. Enter first station number (e.g., **202**)

Press **RIGHT** soft key to move cursor

```
SET RELOCATION
EXT 202 EXT _
```

3. Enter second station number (e.g., **210**)

Press **RIGHT** soft key to enter data

```
SET RELOCATION
EXT 202 EXT 210
```

4. Display will return to **STEP 1**

Go to **STEP 2**

OR press **TRSF** to store and exit programming.

```
SET RELOCATION
EXT _ EXT
```

## CUSTOMER SET RELOCATION ALLOW TABLE

	Single Line	DCS*, DS & iDCS 64 AOM	iDCS 8B	iDCS 18B	iDCS 28B	DS5021D	DS5014D	DS5007S
Single Line	YES	NO	NO	NO	NO	NO	NO	NO
DCS*, DS & iDCS 64 AOM	NO	YES	NO	NO	NO	NO	NO	NO
iDCS 8B	NO	NO	YES	NO	NO	NO	NO	NO
iDCS 18B	NO	NO	NO	YES	YES	NO	NO	NO
iDCS 28B	NO	NO	NO	YES	YES	NO	NO	NO
DS5021D	NO	NO	NO	NO	NO	YES	NO	NO
DS5014D	NO	NO	NO	NO	NO	NO	YES	NO
DS5007S	NO	NO	NO	NO	NO	NO	NO	YES

[DCS Keysets and 32 button AOM not supported on the OS 7100].

# SYSTEM MAINTENANCE ALARMS

The OfficeServ 100, OfficeServ 500, and OfficeServ 7000 systems provide a feature that self-checks for any failures. If a failure does occur in the software or hardware, a fault error will be generated and buffered to an alarm report. During an alarm state every phone with an assigned **SYSTEM ALARM** button will ring and cause the **SYSTEM ALARM** button to flash amber. A phone with a display should be used so that the alarm information can be viewed. When an alarm occurs, the user can press the **SYSTEM ALARM** button to view and scroll through the alarms. This will silence the audible part of the alarm, but the **SYSTEM ALARM** button will continue to flash until your Service Company views and clears the alarms in the alarm report located in the system software.

---

---

## NOTES

---

---

## FEATURES AND SPECIFICATIONS

The OfficeServ telephone systems have preset (default) feature access codes that use the following number plan. These codes can be used if a key is not available for the feature you want to use. Standard telephone users must always dial these codes.

0	Call attendant or system operator	55 + 9	Page all external zones
10 + xxx	Retrieve parked calls	55 +	All page
11	Put calls on and take calls off hold	56	Meet me answer
12 + xxx	Retrieve calls on hold at another station	57	Alarm sensor clear
13	Door lock release	58	DISA alarm clear
16 + xxx	Make speed dial calls	59	Walking class of service
17	Save number and redial it	600	Cancel all call forwarding
18	Recall dial tone for new call	601 + xxx	Set forward all calls
19	Last number redial	602 + xxx	Set forward busy
2xx or 2xxx	Extension numbers	603 + xxx	Set forward no answer
3xx or 3xxx	Extension numbers	604 + xxx	Set fwd busy/no answer
400	Cancel do not disturb	605 + xxx	Set forward on DD
401	Set do not disturb	606 + xxx	Set forward follow me
41	Set message no ring	65	Directed call pickup
42 + xxx	Cancel message	66	Group call pickup
43	Set/return messages	67	Universal answer
44	Busy station/line callback	7xx or 7xxx	Individual line numbers
45	Busy station camp-on	8xx	Trunk groups
46	Set up a conference	9	Trunk group 9 (local)
47	Enter account code		
48	Set programmed station message		
49	Send flash to outside line		
5xx or 5xxx	Station hunt groups		
55 + 0	Page internal zone zero		
55 + 1	Page internal zone 1		
55 + 2	Page internal zone 2		
55 + 3	Page internal zone 3		
55 + 4	Page internal zone 4		
55 + 5	Page external zone 1		
55 + 6	Page external zone 2		
55 + 7*	Page external zone 3		
55 + 8*	Page external zone 4		

\*External zone 3 and 4 not available on the OfficeServ 7100.



[www.samsung.com/bcs](http://www.samsung.com/bcs)

**OfficeServ™**

Standard Telephone  
User Guide

# **STANDARD TELEPHONE USER GUIDE**

for  
OfficeServ™ 100, OfficeServ™ 500  
and OfficeServ™ 7000 Series

*December 2009*



Samsung Telecommunications America reserves the right without prior notice to revise information in this guide for any reason. Samsung Telecommunications America also reserves the right without prior notice to make changes in design or components of equipment as engineering and manufacturing may warrant. Samsung Telecommunications America disclaims all liabilities for damages arising from the erroneous interpretation or use of information presented in this guide.

# TABLE OF CONTENTS

**ABOUT THIS BOOK** .....1

**THINGS YOU SHOULD KNOW** .....2-3

## **OUTSIDE CALLS**

Making an Outside Call .....4  
Answering an Outside Call .....4  
Universal Answer .....4  
Flash/Recall .....4-5  
Busy Line Queuing with Callback .....5

## **INTERCOM CALLS**

Calling Other Stations .....6  
Answering Intercom Calls .....6  
Busy Station Callback .....6  
Busy Station Camp-on .....6  
Calling Your System Operator .....7

## **CALL PROCESSING**

Holding Calls .....8  
Transferring Calls .....9  
Transfer with Camp-On .....9  
Transfer Cancel .....9  
Transfer Recall .....9  
Call Waiting .....10  
Setting Up a Conference .....10  
Forwarding Your Calls .....10-12  
Call Pickup .....12

## **DIALING FEATURES**

<a href="#">Speed Dialing .....</a>	<a href="#">13</a>
<a href="#">Programming Personal Speed Dial Numbers .....</a>	<a href="#">13</a>
<a href="#">Last Number Redial .....</a>	<a href="#">13</a>
<a href="#">Save Number with Redial .....</a>	<a href="#">13</a>
<a href="#">Pulse to Tone Changeover.....</a>	<a href="#">14</a>

## **PAGING AND MESSAGING**

<a href="#">Making an Internal Page .....</a>	<a href="#">15</a>
<a href="#">Making an External Page .....</a>	<a href="#">15</a>
<a href="#">All Page.....</a>	<a href="#">15</a>
<a href="#">Meet Me Page/Answer .....</a>	<a href="#">15</a>
<a href="#">Call Park and Page .....</a>	<a href="#">15</a>
<a href="#">Retrieving a Parked Call .....</a>	<a href="#">16</a>
<a href="#">Setting a Message Indication .....</a>	<a href="#">16</a>
<a href="#">Returning Messages .....</a>	<a href="#">16</a>
<a href="#">Canceling a Message.....</a>	<a href="#">17</a>
<a href="#">Programmed Messages .....</a>	<a href="#">17</a>

## **CONVENIENCE FEATURES**

<a href="#">Do Not Disturb.....</a>	<a href="#">18</a>
<a href="#">Door Phone Calls .....</a>	<a href="#">18</a>
<a href="#">Account Codes .....</a>	<a href="#">18-19</a>
<a href="#">In/Out of Group.....</a>	<a href="#">19</a>
<a href="#">Locking your Station .....</a>	<a href="#">19</a>
<a href="#">Changing your Station Passcode .....</a>	<a href="#">20</a>

## **PERSONAL SPEED DIAL LIST .....**

[21-22](#)

## **ABOUT THIS BOOK**

This booklet provides instructions for using an industry standard single line telephone set with the OfficeServ 100, OfficeServ 500, and OfficeServ 7000 Series systems. A variety of single line sets from many different manufacturers are available. Check with your service and installation company to ensure proper operation with the OfficeServ 100, the OfficeServ 500 and the OfficeServ 7000 Series systems.

Please take the time to study this guide and to become familiar with the operation of your standard telephone. Keep it handy. You may need to look up instructions for infrequently used features.

Learning to use your telephone correctly will make everyday telephone communications a breeze.

This book is written based on the factory default settings for the feature access codes. Sometimes, due to programming requirements, these codes may be changed. If you find that a feature code does not work as described in this book, please contact your installation and service company to determine the correct code.

# THINGS YOU SHOULD KNOW

## USER ORIENTATION

Lifting the handset on your telephone will provide the OfficeServ 100, the OfficeServ 500, and the OfficeServ 7000 Series systems with dial tone. This is also referred to as internal or intercom dial tone. To get an outside line from the telephone company, dial an access code, usually the digit “9.” To call another station in your system, simply dial its extension number. See your system directory list for other access codes and extension numbers.

## HOOKFLASH

Throughout this guide, you will see references to “hookflash.” A hookflash is a momentary operation of the hookswitch required for a feature operation. Some telephones have a **FLASH** key. This key may be pressed instead of the hookswitch.

## C.O. LINES

Lines from the telephone company are “C.O. lines.” Calls on these lines are referred to as “outside calls.” These C.O. lines are accessed by dialing an access code. For example, dial **9** to get a local outside line or dial **800-8XX** for other line groups. Each line in the system is numbered beginning with 701, and then 702, 703, etc. To get a specific line, dial its three digit line number. If Least Cost Routing (LCR) is programmed into the system, you will only be required to dial **9**.

## DISTINCTIVE RINGING

The OfficeServ 100, the OfficeServ 500, and the OfficeServ 7000 Series systems provide distinctive ring patterns to your phone:

- Outside calls have a single ring tone repeated.
- Intercom calls have a double ring tone repeated.
- Door phone calls and alarm/appointment reminders have a triple ring tone repeated.

## SYSTEM TONES

The system provides several tones to assist you. Some of these tones are already familiar to you.

Intercom Dial Tone—A steady tone that indicates you can begin dialing.

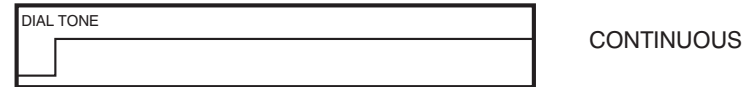

Ringback Tone—Indicates the station you dialed is ringing.

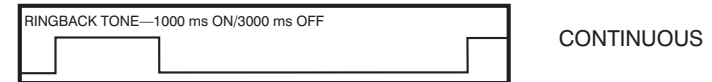

Busy Tone—Indicates the station you dialed is busy.



DND/No More Calls Tone—Fast busy tone indicates the station you dialed is in the Do Not Disturb mode or cannot receive any more calls.

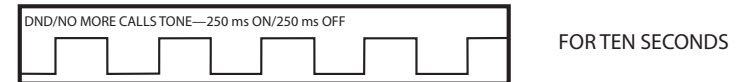

Transfer/Conference Tone—Indicates your call is being held and you can dial another party.



Confirmation Tone—Very short beeps followed by dial tone indicate you have correctly set or canceled a system feature.

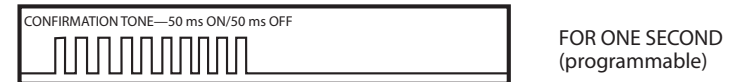

Error Tone—A distinctive two level beeping tone indicates you have done something incorrectly. Try again.



# OUTSIDE CALLS

## MAKING AN OUTSIDE CALL

- Lift the handset and receive internal dial tone.
- Dial a C.O. line or line group access code.
- Receive outside dial tone and then dial the telephone number.
- Finish the call by replacing the handset.

If your system is programmed to require an authorization code before making a call:

- Dial \* and a valid code. You will hear confirmation tone, followed by dial tone.
- Select a C.O. line.

If your system is programmed to require an account code before making a call:

- Dial **47** and a valid code.
- Hookflash and receive transfer tone. Select a C.O. line.

For more information see your system administrator.

## ANSWERING AN OUTSIDE CALL

- Lift the handset. You are automatically connected to the ringing call.
- Finish the call by replacing the handset.

## UNIVERSAL ANSWER

Outside lines may be programmed to ring a general alerting device. To answer calls ringing this device, dial **67**. This device can operate in any system ring mode.

## SENDING A FLASH

While you are on an outside call, hookflash, receive transfer tone and dial **49** to send a flash to the telephone company. This may be required for some custom calling features or CENTREX lines.

Note: Flash is not available on an ISDN circuit.

## RECALL DIAL TONE

Hookflash and then dial **18** to disconnect your outside call and receive telephone company dial tone for a new call.

## BUSY LINE QUEUING WITH CALLBACK

If you receive a busy signal when you select an outside line:

- While on that call, hookflash, receive transfer tone and dial **44**.
- When the line becomes free, the system will call you back.
- Lift the handset, receive dial tone and dial the telephone number or the speed dial number again.

NOTE: A callback will be canceled if it is not answered within 30 seconds.



# INTERCOM CALLS

## CALLING OTHER STATIONS

- Lift the handset.
- Dial the extension number or group number.
- Wait for the party to answer.
- If you hear several brief tone bursts instead of ringback tone, the station you called is set for Voice Announce or Auto Answer.
- Begin speaking immediately after the tone.
- Finish the call by replacing the handset.

## ANSWERING INTERCOM CALLS

- Lift the handset and you are automatically connected to the ringing call.
- Finish the call by replacing the handset.

## BUSY STATION CALLBACK

When you call another station and you receive a busy signal:

- Hookflash, receive transfer tone, dial **44**, receive transfer tone and hang up.
- When the busy station becomes free, your telephone will ring.
- Lift the handset to automatically call the now idle station.

NOTE: You have 30 seconds to answer or the callback will be canceled.

## BUSY STATION CAMP-ON

When you call another station and receive a busy signal but you do not want to wait for a callback:

- Hookflash, receive transfer tone and dial **45**.
- The called station will receive off-hook ring or camp-on tone.
- You will hear ringback tone.
- Wait for the called party to answer.

The called station must release its first call or put it on hold before answering your camp-on.

## CALLING YOUR SYSTEM OPERATOR

- Lift the handset and dial **0** to call your system operator or group of operators.
- If you want to call a specific operator, dial that person's extension number.

# CALL PROCESSING

## HOLDING CALLS

- When you are connected to any call, hookflash, receive transfer tone and dial **11**. The call will now be on hold. You may now make or receive a second call.
- To take the caller off hold, lift the handset and dial **11**. You are now connected to the call. You may resume your conversation.

NOTE: A standard telephone can put only one call on hold at a time.

## HOLD RECALL

If you leave a call on hold longer than the hold timer, the call will recall your station.

- When your phone rings, lift the handset to answer the recall.
- If you do not answer this recall within a pre-programmed period of time, it will go to the operator group.

## RETRIEVING CALLS ON HOLD AT ANOTHER STATION

When a line is on hold at any other station:

- Lift the handset and dial **12** plus the extension number of the station that placed the call on hold—**OR**—dial **12** plus the line number if you know what it is.

## CONSULTATION HOLD

When you are speaking on an outside line and it is necessary to consult with another extension:

- Hookflash and receive transfer tone. Your call is placed on transfer hold.
- Dial an extension number.
- Consult with the internal party.
- Hookflash to return to the outside party or hang up to transfer the call.

NOTE: Repeatedly pressing the hookflash will flip-flop between the outside and inside parties (except if the destination station is set for Auto Answer or Voice Announce, or the system has Transfer Cancel activated).

## TRANSFERRING CALLS

Transfer is used to send any call to another extension in one of two ways. You can perform a screened transfer by informing the other extension who is calling or you can perform a blind transfer without notification.

- While you are speaking on a call, hookflash to receive transfer dial tone and then dial an extension number. Your call is automatically put on transfer hold.
- Hang up when you hear ringing—**OR**—wait for the party to answer and advise the party of the call and then hang up. If the transfer is refused, you will be reconnected to the outside line when the station hangs up or you can hookflash to return to the outside party.

NOTE: After the inside party answers, you may alternate back and forth between the parties by hookflashing.

## TRANSFER WITH CAMP-ON

When you are transferring a call to another station and it is busy, you may camp the call on to this station:

- While you are speaking on a call, hookflash to receive transfer dial tone and then dial an extension number. Your call is automatically put on transfer hold.
- Hang up when you hear a busy signal. The called party will be alerted that a call is waiting.

## TRANSFER CANCEL

If this feature has been activated on your system the Consultation Hold feature will not work. Instead, when you hookflash to return to the outside party after initiating a transfer, the internal party will be dropped allowing you to transfer the call to another destination. This is especially useful if the party you originally tried to transfer to was busy or did not answer.

## TRANSFER RECALL

All calls that you have transferred (screened, unscreened and camped-on) will automatically recall to your station if they are not answered in a pre-programmed period of time.

## CALL WAITING

If an outside call has been camped-on to your phone or another station is camped-on to you:

- You will receive camp-on tone indicating another call is waiting.
- Hookflash and then dial **11** to put the first call on hold.
- Hang up and the waiting call will ring.
- Lift the handset to answer.
- Complete this call by transferring it or hanging up.
- Lift the handset and then dial **11** to return to your first call.

## SETTING UP A CONFERENCE

You may conference five parties (you and four other parties) in any combination of outside lines and internal stations in any order.

- While you are engaged in a conversation, hookflash, receive transfer tone and dial **46**. You will receive conference tone.
- Make another call, either intercom or outside.
- After the called party answers, hookflash and receive conference tone.
- Make another call—**OR**—hookflash to join all parties.
- Repeat as necessary.

To drop a party from your conference call:

- Hookflash, receive confirmation tone and dial the extension or line number that is to be dropped.
- Receive conference tone and dial **46** to rejoin the other parties.

NOTES: To leave the conference, hang up. Control will be passed to the first internal station that was added. If there are no internal stations and you wish to leave outside lines connected together in a trunk to trunk conference, follow the instructions to drop a party and use your extension number. When the parties on the outside lines hang up, the lines will release automatically, proceeding disconnect supervision is supplied by the telephone company.

## FORWARDING YOUR CALLS

You may forward your calls to other stations or groups of stations. When they are programmed, Forward All Calls will have priority over Forward Busy and Forward No Answer conditions.

To clear all call forward conditions set at your station, lift the handset and dial **600**.

NOTE: It is not necessary to clear call forwarding to change your selection; simply enter a new forward command.

## FORWARD ALL CALLS

To forward all of your calls to another station:

- Lift the handset and dial **601** followed by the destination you want your calls to forward to. This can be an internal (within your system) or external (outside your system such as a cell phone) number.
- Receive confirmation tone and hang up.

To cancel Forward All Calls, lift the handset and dial **600—OR—**dial another forward code, e.g., **604**.

## FORWARD BUSY

To forward calls to another station when you are on the phone:

- Lift the handset and dial **602** followed by the destination you want your calls to forward to. This can be an internal (within your system) or external (outside your system such as a cell phone) number.
- Receive confirmation tone and hang up.

To cancel Forward Busy, lift the handset and dial **600—OR—**dial another forward code, e.g., **604**.

## FORWARD NO ANSWER

To forward calls to another station when you do not answer:

- Lift the handset and dial **603** followed by the destination you want your call to forward to. This can be an internal (within your system) or external (outside your system such as a cell phone) number.
- Receive confirmation tone and hang up.

To cancel Forward No Answer, lift the handset and dial **600—OR—**dial another forward code, e.g., **604**.

## FORWARD NO ANSWER/BUSY

To forward calls to another station when you do not answer or when you are on the phone:

- Lift the handset and dial **604**.
- Receive confirmation tone and hang up.

NOTE: This option will only work if Forward No Answer and Forward Busy destinations are already programmed.

To cancel Forward No Answer/Busy, lift the handset and dial **600—OR—**dial another forward code, e.g., **601**.

## FORWARD FOLLOW ME

When you want all calls to your extension forwarded to the extension where you are now:

- Dial **606** plus your extension number.
- Receive confirmation tone and hang up.

If you want a specific extension's calls forwarded to your phone (Remote Call Forward):

- Dial **606** plus the desired extension number.
- Receive confirmation tone and hang up.

To cancel Forward Follow Me, lift the handset and dial **600—OR—**dial another forward code, e.g., **601**.

## FORWARD DND

To forward your phone when you activate DND.

- Dial **605** followed by the destination you want your calls to forward to. This can be an internal (within your system) or external (outside your system such as a cell phone) number.
- Receive confirmation tone and hang up.

## STATION CALL PICKUP

To pick up (answer) a call ringing at another station:

- Lift the handset and dial **65** plus the extension number of the ringing phone.

## GROUP CALL PICKUP

To pick up (answer) a call ringing in any pickup group:

- Lift the handset and dial **66** plus the desired group number.

### GROUP NUMBERS

<b>01-10</b>	<b>OfficeServ 7030</b>
<b>01-20</b>	<b>OfficeServ 100, OfficeServ 7100 and OfficeServ 7200-S</b>
<b>01-99</b>	<b>OfficeServ 500 M</b>
<b>01-99</b>	<b>OfficeServ 500 L</b>
<b>01-99</b>	<b>OfficeServ 7200 and OfficeServ 7400</b>

NOTE: Station and group pickup features cannot be used to answer recalls to a station, only new ringing calls and operator recalls.

## DIALING FEATURES

### SPEED DIALING

You can dial a preprogrammed telephone number stored in the system-wide speed dial list of numbers 500–999 or from your personal list of numbers 00–49.

- Lift the handset and dial **16**.
- Dial the desired speed dial number.
- The telephone number is automatically dialed for you.

NOTE: Your system may be set for 950 system wide numbers. If so the system speed dial access codes are 050~999 and the station speed dial codes are 000~049.

### PROGRAMMING PERSONAL SPEED DIAL NUMBERS

To program personal speed dial numbers:

- Lift handset to go offhook.
- Dial **15105** the next available speed dial bin number (e.g. **01**), a trunk or trunk group number and your speed dial digits.
- Listen for system dial tone and replace handset.

NOTE: It is much easier to have your System Administrator program these for you.

### LAST NUMBER REDIAL

To redial the last telephone number you have dialed:

- Lift the handset and dial **19**.

NOTE: Redial does not apply to intercom calls.

### SAVE NUMBER WITH REDIAL

To save the number you have just dialed for later use:

- Before hanging up, hookflash, receive confirmation tone and dial **17**.

To redial this saved number at any time:

- Lift the handset and dial **17**. This step will select the same line and dial the number for you.

This telephone number is stored in memory until you save another. When you do, the new number will be saved and the old number will be erased.

NOTE: Save Number does not apply to intercom calls.

## PULSE TO TONE CHANGEOVER

When making an outside call on a dial pulse line, press #. All digits dialed after the # will be sent as tones.

## PAGING AND MESSAGING

### MAKING AN INTERNAL PAGE

To make an announcement through the keyset speakers in the idle condition:

- Lift the handset.
- Dial **55** plus zone number **0, 1, 2, 3** or **4**.
- After the brief attention tone, make the announcement.

### MAKING AN EXTERNAL PAGE

To make an announcement through the external paging speakers:

- Lift the handset.
- Dial **55** plus zone number **5, 6, 7** or **8**—OR—dial **55** plus **9** to page all external zones.
- After the brief attention tone, make the announcement.

### ALL PAGE

To page all designated keysets in internal zone 0 and all external zones at the same time:

- Lift the handset and dial **55** plus **\***.
- After the brief attention tone, make the announcement.

### MEET ME PAGE/ANSWER

- Make a page by dialing **54** plus any zone and instruct the paged person to dial **56**.
- After completing the page, hookflash and remain off-hook until the paged person dials **56** from any phone. The paged person will be automatically connected with you.

### CALL PARK AND PAGE

When you have an outside call for someone who is not at his/her desk, you can park the call and page the requested party:

- While in conversation, hookflash and dial **55**. The call is automatically parked at your station.
- Dial the desired page zone and make the announcement. Be sure to include your station number, for example, "Mr. Smith, park 201."

## RETRIEVING A PARKED CALL

To retrieve a call that has been parked for you:

- Lift the handset.
- Dial **10** plus the station number that was announced. You will be connected to the parked call.

## SETTING A MESSAGE INDICATION

When you are calling another station and no one answers or you receive a busy signal, you can set a message indication at that station. The **MESSAGE** key on keysets will flash and standard telephones will receive special dial tone and light their message lamp if their phone is equipped with one and they are on a 16DSL card.

- Hookflash and dial **43**.
- Receive confirmation tone and hang up.

If the keyset you are calling is in the Auto Answer mode, you must use the following procedure:

- Hang up for at least two seconds.
- Lift the handset.
- Dial **41** plus the extension number.
- Receive confirmation tone and then hang up.

NOTE: A station can have up to and including five message indications. If you receive dial tone instead of confirmation tone, there are already five messages at this station. Try again later.

## RETURNING MESSAGES

When you see your message indicating lamp flashing if your phone is equipped with one and your phone is connected to an 8MWSLI or a 16 MWSLI card or you lift the handset and receive special dial tone, another station has left a message for you. To return messages:

- Lift the handset.
- Dial **43**. The first station that left you a message will be called automatically. If it is not answered, your message indication will remain.
- Repeat the prior step until all messages have been returned in the order received.
- Dial tone will return to normal when all messages have been returned.

## CANCELING A MESSAGE

You can cancel a message indication that you have left at another station.

- Lift the handset.
- Dial **42** plus the extension number of that station.

To cancel all message indications left at your phone:

- Lift the handset and dial **42** plus your extension number.
- Replace the handset.

## PROGRAMMED MESSAGES

When you will be away from your phone for any length of time, you may leave a programmed station message. Display stations calling you will see this message and be informed of your status or follow your instructions.

- Lift the handset and dial **48** plus any message code, **01–20** listed on the back of this user guide.
- Listen for confirmation tone and hang up.
- To cancel this message, lift the handset and dial **48** plus **00**.

# CONVENIENCE FEATURES

## DO NOT DISTURB

Use Do Not Disturb (DND) when you want to block calls to your keyset.

- Lift the handset and then dial **401**.
- To cancel DND, lift the handset and then dial **400**.

You are able to make calls while in the DND mode.

## ANSWERING THE DOOR PHONE

When your station is programmed to receive calls from the door phone:

- You will receive three short rings repeatedly.
- Lift the handset and you will be connected to the door phone.
- If an electric door lock release is installed, hookflash, receive confirmation tone and dial **13** to release the lock.

## CALLING THE DOOR PHONE

### (ROOM MONITORING)

You can call the door phone and listen to what is happening outside or in another room.

- Lift the handset and then dial the extension number of the door box.
- You will be connected to the door phone. You can listen or have a conversation.
- If an electric door lock release is installed, hookflash, receive confirmation tone and dial **13** to release the lock.

## ACCOUNT CODES

When enabled, your system allows calls to be changed to different accounts. You can enter account codes either by dialing the full code or by entering an account code "bin number". The type of code used is set by your telephone system administrator. Codes can be entered at any one of the three different times:

To enter an account code before placing the call:

- Lift the handset and dial **47**.
- Dial the account code or bin number (bin numbers are 3 digits, account codes may be a maximum of 12 digits, and # may be used).
- Receive confirmation tone and dial **9** and the telephone number.

To enter an account code by interrupting the conversation:

- While on an outside call perform a hookflash, receive confirmation tone, and dial **47**.
- Dial the account code or bin number (bin numbers are 3 digits, account codes may be a maximum of 12 digits, and # may be used).
- Hookflash to return to the conversation.
- If you make an error, repeat the procedure with the correct code. Only the most recent account code dialed will be recorded.

To enter an account code after the outside party hangs up:

- Perform a hookflash, receive confirmation tone, and dial **47**.
- Dial the account code or bin number (bin numbers are 3 digits, account codes may be a maximum of 12 digits, and # may be used).

NOTE: If you wait for the outside party to hang up, you must complete this procedure within 10 seconds. You cannot repeat if an incorrect number is entered.

## IN/OUT OF GROUP

If your station is assigned to a hunt group, this feature will allow you to dial an **access code** plus the group number, e.g., **501**, plus **0** to temporarily prevent your station from receiving any group calls. You will still be able to receive calls that are dialed directly to your station. To reenter the group, dial an **access code** plus the group number, e.g., **501**, plus **1**.

## LOCKING YOUR STATION

	0 UNLOCKED	1 LOCKED OUTGOING Hold Button LED Flashes	2 LOCKED ALL CALLS Hold Button LED Solid
Make outside calls	YES	NO (ACCESS DENIED)	NO
Receive outside calls	YES	YES	NO
Make intercom calls	YES	YES	NO
Receive intercom calls	YES	YES	NO
Make 911 calls	YES	YES*	NO

To lock your phone from making outgoing calls:

- Lift handset to go offhook and dial **15100** plus your station passcode (default **1234**) then dial **1**.
- Listen for system dial tone and replace handset. Your station is now locked from making outgoing calls.

Note\*: When 911 is programmed, 911 emergency dialing is allowed for a LOCKED OUTGOING station.

To lock your station from making both internal and outgoing calls:

- Lift handset to go offhook and dial **15100** plus your station passcode (default **1234**) then dial **2**.
- Listen for system dial tone and replace handset. Your station is now locked from making both internal and outgoing calls.

To unlock your phone:

- Lift handset to go offhook and dial **15100** plus your station passcode (default 1234) then dial **0**.
- Listen for system dial tone and replace handset. Your station is now unlocked.

## CHANGING YOUR STATION PASSCODE

To change your station user passcode:

- Lift handset to go offhook then dial **15101**
- Then dial your existing station passcode
- Then dial a new passcode (must be four digits)
- Listen for confirmation tone then replace the handset

## PERSONAL SPEED DIAL NUMBERS

CODE	NAME	TELEPHONE NUMBER
00	_____	_____
01	_____	_____
02	_____	_____
03	_____	_____
04	_____	_____
05	_____	_____
06	_____	_____
07	_____	_____
08	_____	_____
09	_____	_____
10	_____	_____
11	_____	_____
12	_____	_____
13	_____	_____
14	_____	_____
15	_____	_____
16	_____	_____
17	_____	_____
18	_____	_____
19	_____	_____
20	_____	_____
21	_____	_____
22	_____	_____
23	_____	_____
24	_____	_____



# PERSONAL SPEED DIAL NUMBERS

CODE	NAME	TELEPHONE NUMBER
25	_____	_____
26	_____	_____
27	_____	_____
28	_____	_____
29	_____	_____
30	_____	_____
31	_____	_____
32	_____	_____
33	_____	_____
34	_____	_____
35	_____	_____
36	_____	_____
37	_____	_____
38	_____	_____
39	_____	_____
40	_____	_____
41	_____	_____
42	_____	_____
43	_____	_____
44	_____	_____
45	_____	_____
46	_____	_____
47	_____	_____
48	_____	_____
49	_____	_____

---

---

# NOTES

---

---

# NOTES

## FEATURES AND SPECIFICATIONS

### LINE GROUPS

9 Local/LCR \_\_\_\_\_  
 800 \_\_\_\_\_  
 801 \_\_\_\_\_  
 802 \_\_\_\_\_

### STATION GROUPS

501 \_\_\_\_\_  
 502 \_\_\_\_\_  
 503 \_\_\_\_\_  
 504 \_\_\_\_\_

### PAGING ZONES - DIAL 55 PLUS

0 All Internal Zones \_\_\_\_\_  
 1 \_\_\_\_\_  
 2 \_\_\_\_\_  
 3 \_\_\_\_\_  
 4 \_\_\_\_\_  
 5 \_\_\_\_\_  
 6 \_\_\_\_\_  
 7 \_\_\_\_\_  
 8 \_\_\_\_\_

9 All External Zones \_\_\_\_\_  
 \*All External Zones and Internal Zone 0

### PROGRAMMED MESSAGES

01 In A Meeting \_\_\_\_\_  
 02 Out On a Call \_\_\_\_\_  
 03 Out To Lunch \_\_\_\_\_  
 04 Leave A Message \_\_\_\_\_  
 05 Page Me \_\_\_\_\_  
 06 Out Of Town \_\_\_\_\_  
 07 In Tomorrow \_\_\_\_\_  
 08 Return Afternoon \_\_\_\_\_  
 09 On Vacation \_\_\_\_\_  
 10 Gone Home \_\_\_\_\_  
 11 \_\_\_\_\_  
 12 \_\_\_\_\_  
 13 \_\_\_\_\_  
 14 \_\_\_\_\_  
 15 \_\_\_\_\_  
 16\* \_\_\_\_\_  
 17\* \_\_\_\_\_  
 18\* \_\_\_\_\_  
 19\* \_\_\_\_\_  
 20\* \_\_\_\_\_

\*Programmed Messages 16--20 not available on OS 7030, 7100, and 7200-S.

### FEATURE ACCESS CODES

10 + xxx	Pick Up A Parked Call
12 + xxx	Pick Up A Held Call
HF-13	Door Lock Release
16 + xxx	Speed Dialing
17	Save And Redial Number
18	New Call (Recall)
19	Last Number Redial
400	Cancel Do Not Disturb
401	Set Do Not Disturb
42 + xxx	Cancel Message You Left
43	Return Message
HF-44	Callback
HF-45	Busy Station Camp-On
HF-46	Conference
HF-47	Account Code
48 + xx	Cancel Programmed MSG
HF-49	Send Flash To C.O. or PBX
56	Meet Me Answer
600	Cancel All Call Forward
601 + xxx	Set Forward All Calls
602 + xxx	Set Forward Busy
603 + xxx	Set Forward No Answer
604 + xxx	Set Fwd Busy/No Answer
605 + xxx	Set Forward on DND
606 + xxx	Set Forward Follow Me
65 + xxx	Pick Up Ringing Extension
66 + xx	Pick Up Group
67	Universal Answer
*	Authorization Code

Note: HF Indicates Hookflash.



[www.samsung.com/bcs](http://www.samsung.com/bcs)